



# 3m Anechoic Chamber (AC-3M) Brochure

## Global Office of Lisun Electronics Inc.

<http://www.Lisungroup.com>

Lisun Group (Hong Kong) Limited

Add: Room 803, Chevalier House, 45-51 Chatham Road South, Tsim Sha Tsui, KL, HK

Tel: 00852-68852050 Fax: 00852-30785638

Email: SalesHK@Lisungroup.com

Lisun Electronics (Shanghai) Co., Ltd

Add: 113-114, No. 1 Building, Nanxiang Zhidi Industry Park, No. 1101, Huiyi Road, Jiading District, Shanghai, 201802, China

Tel: +86(21)5108 3341 Fax: +86(21)5108 3342

Email: SalesSH@Lisungroup.com

Lisun Electronics Inc. (USA)

Add: 445 S. Figueroa Street, Los Angeles, CA 90071, U.S.A.

Email: Sales@Lisungroup.com

Lisun China Factory

Add: NO. 37, Xiangyuan Road, Hangzhou City, Zhejiang Province, China

Tel: +86-189-1799-6096

Email: Engineering@Lisungroup.com

**Leader in Lighting & Electrical Test Instruments**

Rev. 3/1/2024

## Chapter 1: AC-3M

# Anechoic Chamber

### 1.1 Project Name

- 3 m Anechoic Chamber - External Shielding Dimensions 9.2×6.2×6.3m (LISUN Model: AC-3M)
- 5 m Anechoic Chamber - External Shielding Dimensions 12×7.6×6.6m (LISUN Model: AC-5M)

### 1.2 Darkroom Performance

Shielding Performance: According to standards EN50147-1, GB/T 12190-2006

Field	Frequency	Shielding Performance (dB)
Magnetic Field	14KHz	75
Magnetic Field	200KHz	100
Electric Field	15MHz	100
Plane Wave	450MHz	100
Plane Wave	1000MHz	100
Microwave	1GHz ~ 18GHz	100

\*Shielded room only measured up to 1000MHz

#### Normalized Field Attenuation:

Within the frequency range of 30MHz to 1GHz, according to the testing method specified in ANSI C63.4-2003, the Normalized Site Attenuation (NSA) values measured within the quiet zone are superior to  $\pm 3.5$ dB compared to theoretical NSA values. This meets the requirements of CISPR22 Class B for 3 m Anechoic Chamber, while also complying with standards ANSI C63.4, CISPR 16-1, EN50147-2, and ANSI C63.4. The frequency range covered is from 30MHz to 1GHz. With the transmitting antenna height (TX) for horizontal polarization at 1 meter and 2 meters, and for vertical polarization at 1 meter and 1.5 meters. The

receiving antenna height (RX) is for both horizontal and vertical polarizations at heights ranging from 1 to 4 meters with a scanning antenna. The measurement distance is 3 meters with both horizontal and vertical polarizations. The transmitting antenna's measurement positions include five locations (center, front, left, right, rear), with a testing diameter of 1.5 meters.

### **Site Voltage Standing Wave Ratio**

In accordance with the requirements of CISPR 16-1-4, within the frequency range of 1GHz to 18GHz, testing the S<sub>vswr</sub> (Site Voltage Standing Wave Ratio) should have a maximum deviation of S<sub>vswr</sub> ≤ 6dB.

The standard CISPR 16-1-4 specifies a frequency range from 1GHz to 18GHz, with the transmitting antenna (TX) positioned at heights of 1 meter and 1.5 meters, and the receiving antenna (RX) positioned at heights of 1 meter and 1.5 meters. The measurement distance is 3 meters with both horizontal and vertical polarizations. The transmitting antenna's measurement positions include four locations (center, front, left, right). The testing diameter is 1.5 meters.

## **1.3 Project Content**

### **1.3.1 Shielding Design Drawings (Using the 3 m Anechoic Chamber as an Example)**

3 m Anechoic Chamber - External Shielding Dimensions 9.2×6.2×6.3m (LISUN Model: AC-3M)

Skeleton supports the Anechoic Chamber, with external dimensions of 9.5×6.5×6.6m

Shielding steel plates are 2mm thick galvanized steel plates, with external dimensions of 9.2×6.2×6.3m

5m Anechoic Chamber - External Shielding Dimensions 12×7.6×6.6m (LISUN Model: AC-5M)

Skeleton supports the Anechoic Chamber, with external dimensions of 13×8.5×7.6m

Shielding steel plates are 2mm thick galvanized steel plates, with external dimensions of 12×7.5×6.6m

3m Anechoic Chamber 3D cross-sectional view (left perspective)

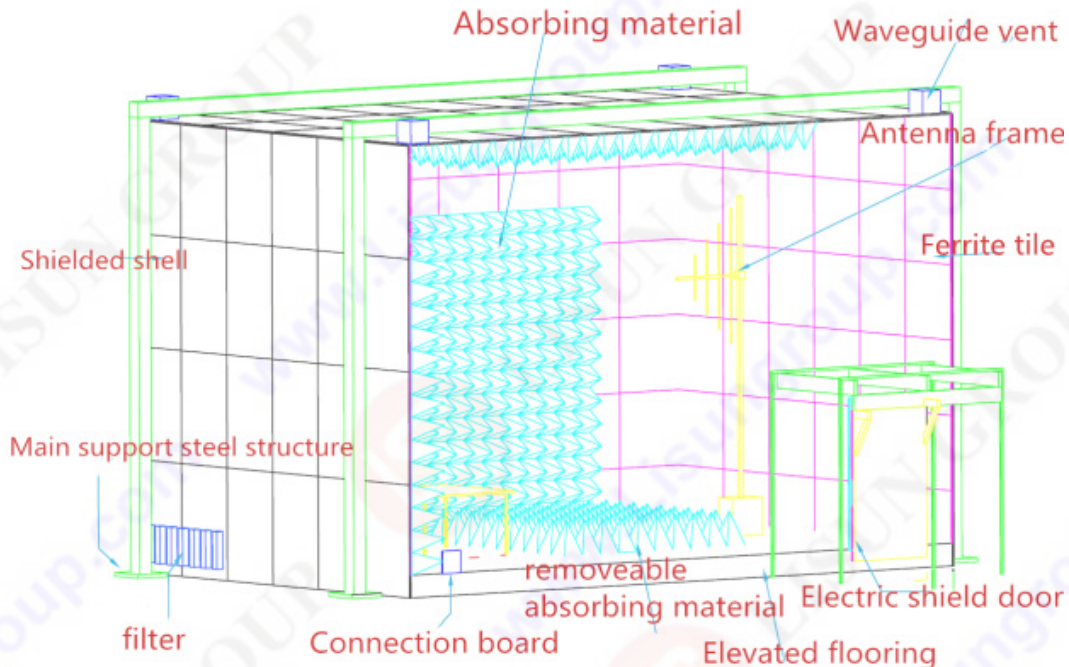

3m Anechoic Chamber 3D cross-sectional view (right perspective)

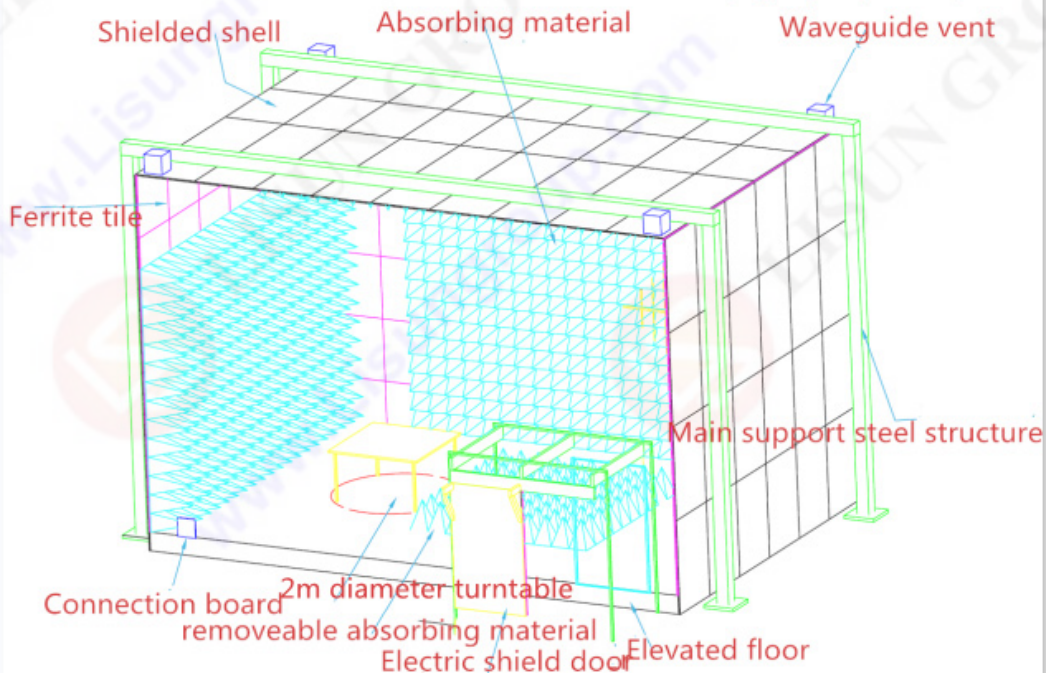

### 1.3.2 Shielding Door

Electric shielding door measuring 1.2×2m



### 1.3.3 Filters

Filter is a low -leakage current EMC dark room special filter. According to MIL-STD-220A load conditions, the minimum insertion loss within the frequency range of 100KHz to 18GHz is 100dB.

**The required number of filters:**

Type	Specifications	Quantity	Function/Role
Three-phase four-wire power supply filter	60A 440VAC	1	EUT Power Supply
DC filter	100A 1000VDC	1	EUT Power Supply
Single -phase filter	32A 250V	1	EUT Power Supply , The customer needs to provide a variable frequency power supply.
Single -phase filter	32A 220V	1	Power supply for turntables, antenna towers, and monitoring equipment.
Single -phase filter	32A 220V	1	Power supply for testing equipment and lighting.
Single -phase filter	32A 220V	1	Backup power supply



#### 1.3.4 Ventilation Windows

Four waveguide windows configured with a cutoff frequency of up to 18GHz.

#### 1.3.5 Raised Flooring

Approximately 250mm in height, capable of bearing 1000kg/sqm, with a 3mm thick stainless steel surface.

#### 1.3.6 Main Power Control cabinet

Equipped with air switches to individually control each filter and ground interface box. Used for signal interface board wiring or installation of power sockets.

#### 1.3.7 Lighting

Four 300W halogen lamps for illumination. The lighting devices utilize halogen lamps that do not produce electromagnetic interference, each rated at 300W. They are installed at the four corners of the darkroom for easy maintenance. The lighting device switches are installed near the door and controlled in two separate circuits.



#### 1.3.8 Absorbing Materials

Dielectric boards (flame-retardant multi-layer boards + 0.5mm copper foil) used for installing fixed ferrite tiles.

Ferrite tiles from SAMWHA, South Korea, laid on walls and ceiling, secured with screws.

Absorbing cones from China Dongxin brand, laid on walls and ceiling, including materials required for ground when measuring SVSWR.

#### **Ferrite Tiles**

Size: 100x100x6.7mm

Installed with ferrite-specific washers designed by LISUN, connected with screws to the darkroom walls and top insulating materials, featuring a smooth surface for easy disassembly. Ferrite tiles are installed in a staggered manner.



#### **Absorbing Cones**

Polyurethane absorbing cones composed of a compound of ferrite produced by LISUN are used inside the Anechoic Chamber. They are installed on the surface of the ferrite using devil adhesive for easy removal.



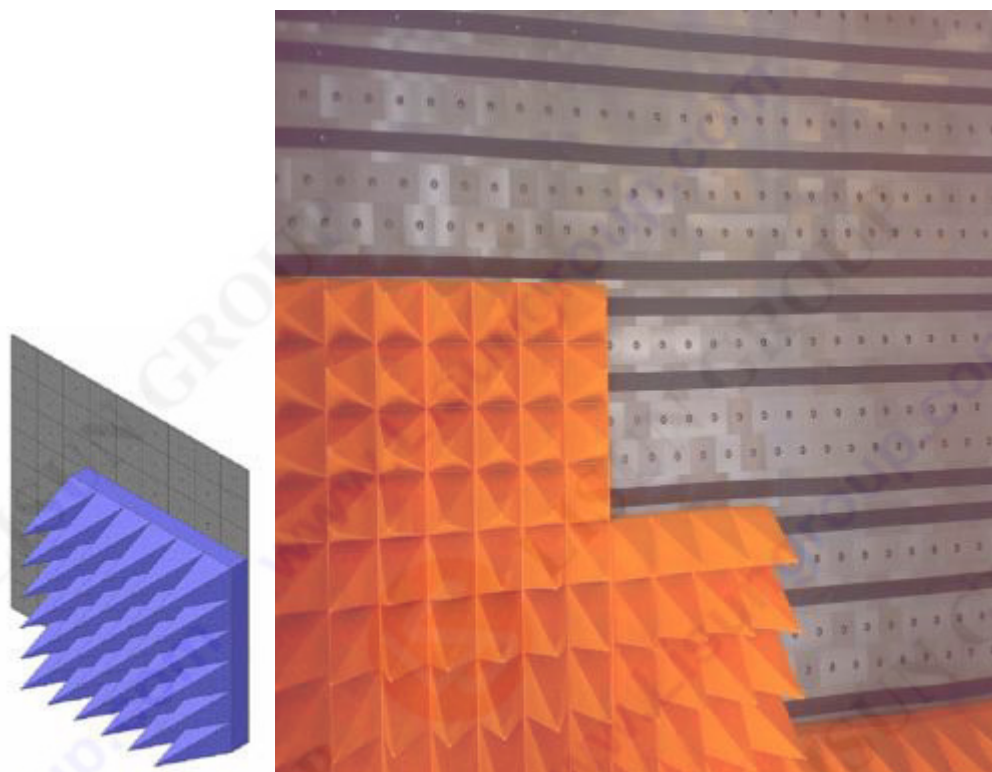

In the main reflection area of the darkroom walls and ceiling, SA-F500 is used, while SA-F300 is used in the non-main reflection areas. During Site Voltage Standing Wave Ratio (SVSWR) testing, 9 square meters of SA-300 are placed on the ground. The SA-F series absorbing materials are processed and produced using polyurethane sponge solid raw material substrates.

**Specifications:**

SA-F300 (300mm)

Dimensions: 600mm (L) × 600mm (W) × 300mm (H)

SA-F500 (500mm)

Dimensions: 600mm (L) × 600mm (W) × 500mm (H)

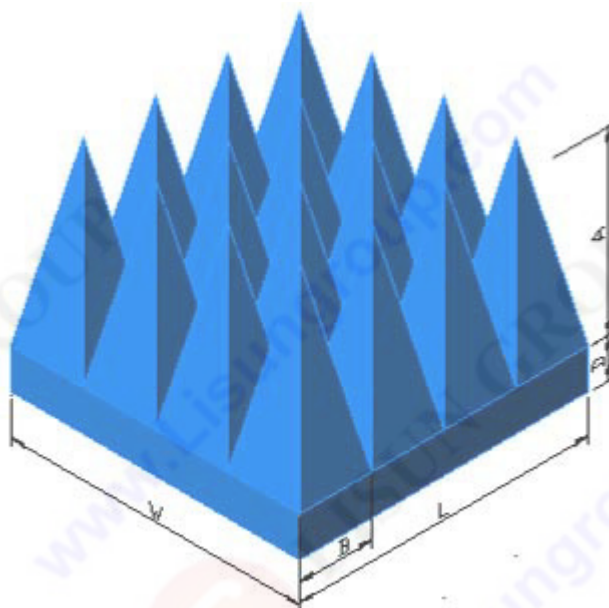

#### **Physical Performance:**

- Appearance Color: The appearance is sleek and beautiful, with no cracks. The cones are arranged neatly with no noticeable bending during long-term use. The cones are light blue in color, with uniform and consistent hue.
- Environmental Performance: Non-toxic and odorless, without any powdering or residue.
- Service Life: Maintains good tensile and tear strength of the absorbing material. No significant signs of aging within the shelf life.

#### **Safety Performance:**

The production process of polyurethane foam materials is controlled with comprehensive testing equipment during manufacturing and final inspection to ensure compliance with all safety indicators. It meets the combustion performance requirements of HB7068-1-HB7068-4-94 and other standards for polyurethane foam absorbing materials used in RF non-reflective microwave darkrooms.

#### **Standard Requirements:**

- NRL Report-8093: Safety performance of sponge-based absorbing materials, including requirements for smoldering, voltage resistance, and flame propagation.
- GB/T2406-93: Plastic combustion performance test, with an oxygen index of  $\geq 28\%$ , meeting the B2 flame retardant standard.

**Environmental Performance:**

Polyurethane products strictly control raw materials and production processes. The finished absorbing materials have passed SGS ROHS certification, meeting environmental requirements for the export of electronic products. They have power resistance performance, with a working temperature range of -50°C to +100°C, and can withstand temperatures of up to 120°C for short periods. The power capacity is 1kW/m<sup>2</sup> and 1.5kW/m<sup>2</sup> for short durations. The electrical properties of the absorbing materials are matched with ferrites.

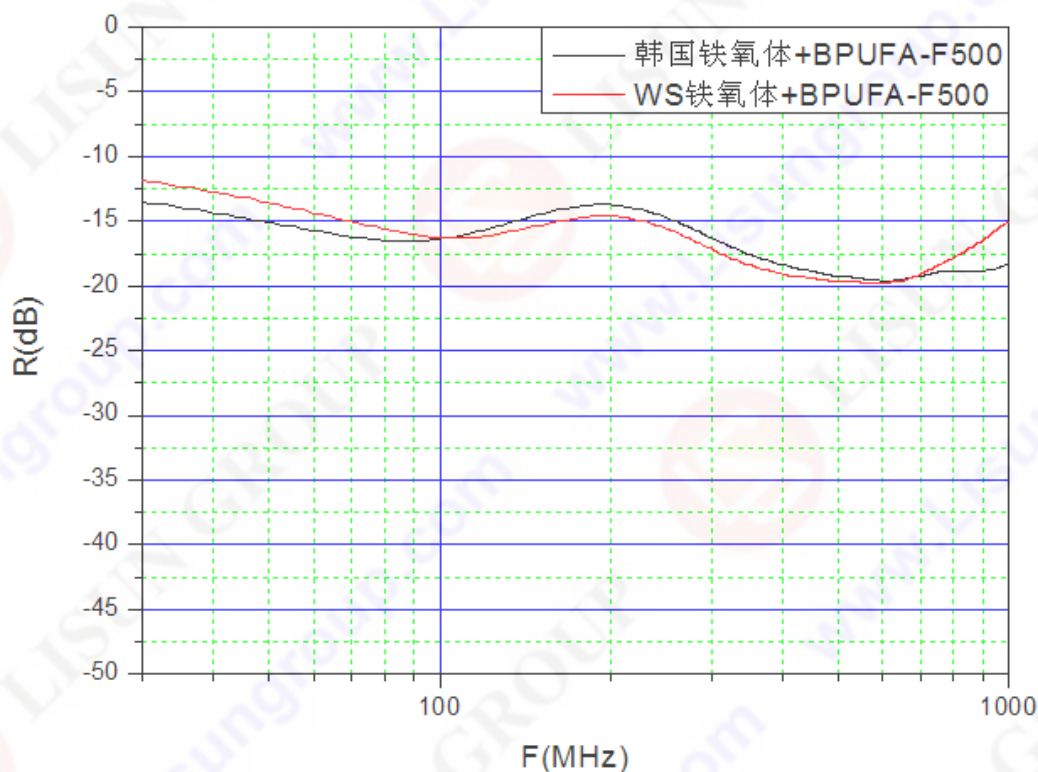

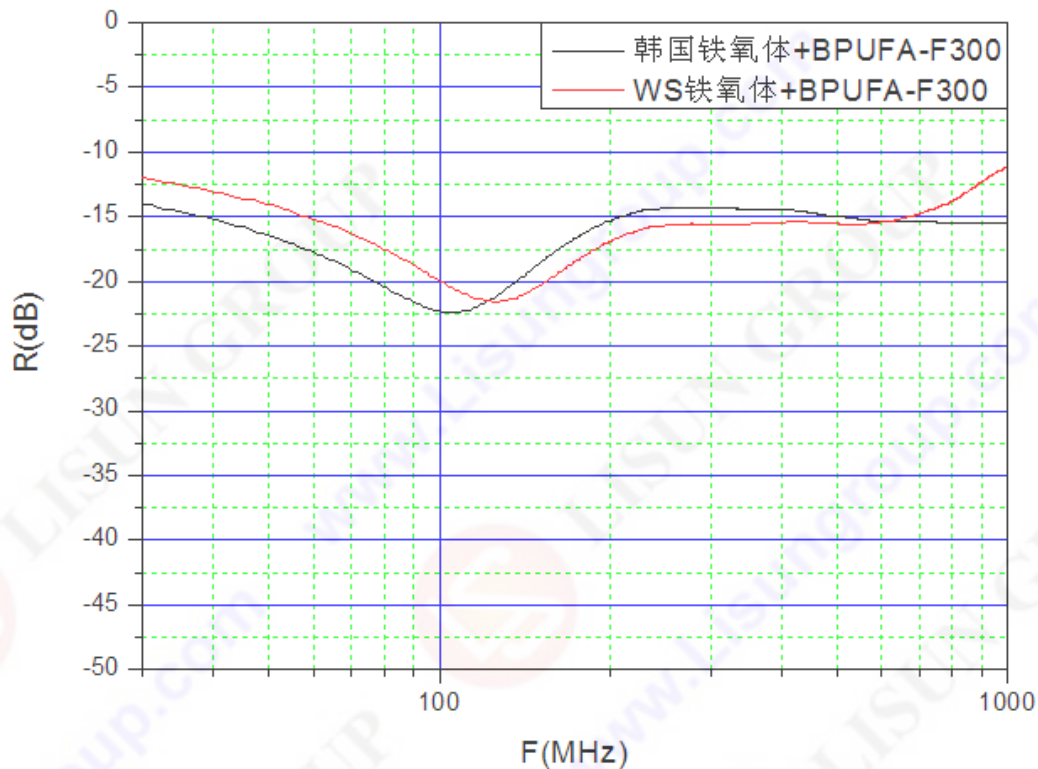

### 1.3.9 Turntable

A turntable with a low-emission motor is used, installed at the same height as the raised floor. A power socket is provided at the center of the turntable.

- Fiber optic control
- Embedded
- Diameter: 1.5m
- Load capacity: 500 kg
- Rotation speed: 2 revolutions per minute (can be adjusted to 30 seconds to 6 minutes per revolution), adjustable from 1 to 12 degrees per second
- Rotates clockwise or counterclockwise from 0 to 360 degrees.

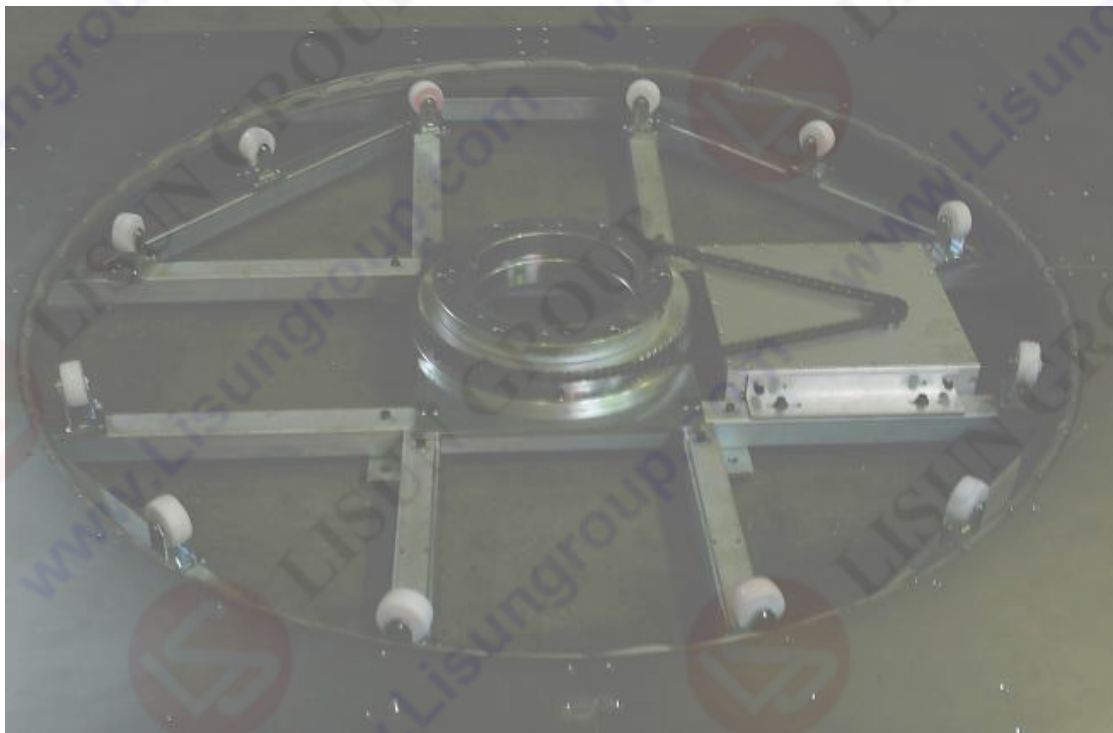
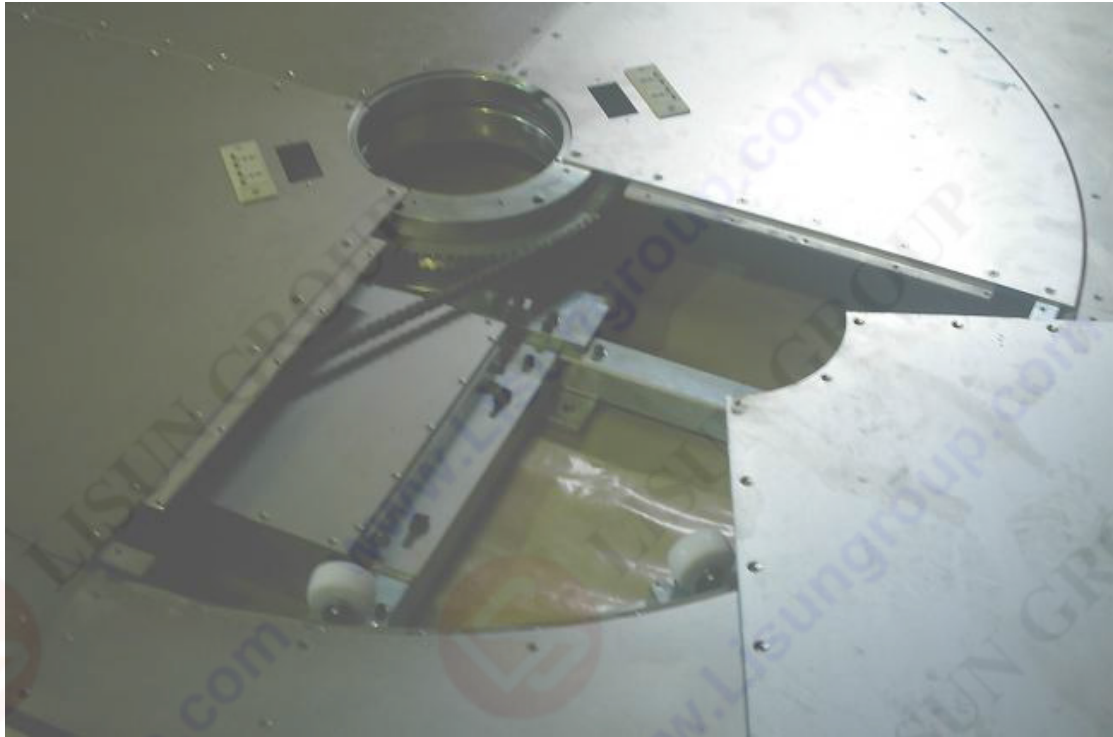



#### 1.3.10 Antenna Tower

- Fiber optic control
- Remote control for telescoping from 1 to 4 meters, electrically driven
- Automatic control for vertical and horizontal polarity change, pneumatically driven
- Load capacity: 10 kg (at the end of the pole)
- Mast made of fiberglass material
- Speed adjustable from 1 to 12 cm/s
- Fixture provided according to the customer's antenna model.



### 1.3.11 Controller

- Fiber optic control for turntable and antenna tower
- GPIB interface, compatible with testing software



### 1.3.12 Surveillance System

- The monitoring system includes the following equipment: a color camera (Panasonic WV-CP500) and a 32" color monitor. This camera comes with a pan-tilt-zoom (PTZ) function and remote zoom capability. The WV-CP500 is a fifth-generation Super Dynamic (SD5), 650-line ultra-high-definition intelligent analysis day-night camera.
- Horizontal resolution: 650 lines in color mode, 700 lines in black and white mode.
- Minimum illumination: 0.0003 Lux (SENS UP mode). With filter lens day-night switching function (automatic/manual).
- Intelligent functions: Automatic motion detection, packet loss detection, automatic back focus adjustment (ABF). Scene change detection function.





Remark: The images above are for illustration purposes only. The company reserves the right to change the appearance and design of the product.

### 1.3.13 Smoke Alarm Sound and Light Alarm

Inside the darkroom, an infrared alarm and smoke detection system are installed, and signals are sent to sound and light alarms outside the darkroom. The layout and installation of fire automatic alarm detectors and security equipment should ensure the electromagnetic environmental performance requirements of the darkroom. Performance characteristics: It uses new red LED as the light source, with high brightness and strong signal, long visible distance, and strong penetration ability through thick smoke and fog. The alarm sound has strong penetration ability.



## Chapter 2: Control of the Shielded Room

### 2.1 Project Name

Controlled Shielded Room - External Shielding Dimensions 5.0×4.0×3.0m  
(Customizable according to requirements)

### 2.2 Shielded Room Performance

Shielding Performance: According to standards EN50147-1, GB/T 12190-2006:

Field	Frequency	Shielding Performance (dB)
Magnetic Field	14KHz	60
Magnetic Field	200KHz	80
Electric Field	15MHz	100
Plane Wave	450MHz	100
Plane Wave	1000MHz	100
Microwave	1GHz ~ 18GHz	90

\*The shielded room is only tested up to 1000MHz. It is equipped with a 1.2×2m manual shielding door. Other configurations are detailed in the fourth section: Common Configurations.

### 2.3 Filter Configuration

The filters are specialized low-leakage current EMC darkroom filters. According to MIL-STD-220A load conditions, the minimum insertion loss within the frequency range of 100KHz to 18GHz is 100dB.

The required number of filters:

Type	Specification	Quantity	Function
Single-phase filter	32A 250V	1	The EUT is powered, and the customer needs to provide a variable frequency power supply.
Single-phase filter	32A 220V	1	Power supply for testing equipment and lighting.

## Chapter 3: Amplifier Shielded Room

### 3.1 Project Name

Amplifier Shielded Room - External Shielding Dimensions 3.0×3.0×3.0m  
(Customizable according to requirements)

### 3.2 Shielded Room Performance

Shielding Performance: According to standards EN50147-1, GB/T 12190-2006

Field	Frequency	Shielding Performance (dB)
Magnetic Field	14KHz	60
Magnetic Field	200KHz	80
Electric Field	15MHz	100
Plane Wave	450MHz	100
Plane Wave	1000MHz	100
Microwave	1GHz ~ 18GHz	90

\*The shielded room is only tested up to 1000MHz. It is equipped with a 1.2×2m manual shielding door. Other configurations are detailed in the fourth section: [Common Configurations](#).

### 3.3 Filter Configuration

The filters are specialized low-leakage current EMC darkroom filters. According to MIL-STD-220A load conditions, the minimum insertion loss within the frequency range of 100KHz to 18GHz is 100dB.

The required number of filters:

Type	Specification	Quantity	Function
Three-phase four-wire power supply filter	60A 440VAC	1	EUT Power Supply
Single-phase filter	32A 220V	1	Power supply for testing equipment and lighting.

## Chapter 4: Common Configurations

### 4.1 Shielding Enclosure

Composed of 2mm thick galvanized steel plates, the steel plates are surface-coated with spray paint to protect against environmental temperature and humidity. The assembly depth is 50mm, with fixed spacing of 50mm. Stainless steel screws of M8 are used for fastening. A single 2mm steel plate can achieve high shielding efficiency. This structural form, along with special copper cotton conductive pads, ensures the shielding effect of the gaps. A large number of standardized assembled darkrooms can achieve a good performance-to-price ratio and are easy to relocate. They feature simple and fast installation without on-site welding.

All shielding products fully comply with all relevant international standards: CISPR; EN; VDE; NSA65-6; MIL-STD-285; MIL-STD-461; MIL-STD-462; FCC OST 55; ANSI C63; IEC; VG.



The external framework adopts a self-supporting structure and does not require additional support from the host building.



#### 4.2 Shielded Door

The shielded door is completely independent, featuring a unique single-knife wide-edge design, with no visible locking mechanism on the exterior, ensuring high shielding performance. The springs on the door are fixed with screws for easy maintenance. It is a hinged electric door, with a clear opening size of 1.2×2m (W×H), equipped with a password lock. In the event of a power outage, the positioning device at the switch of the shielded door can be manually operated to open and close the door.



### 4.3 Ventilation Waveguide Windows

Four full-copper waveguide windows, each measuring 300mm × 300mm, are installed at the top of the darkroom to serve as air inlet and outlet ports.

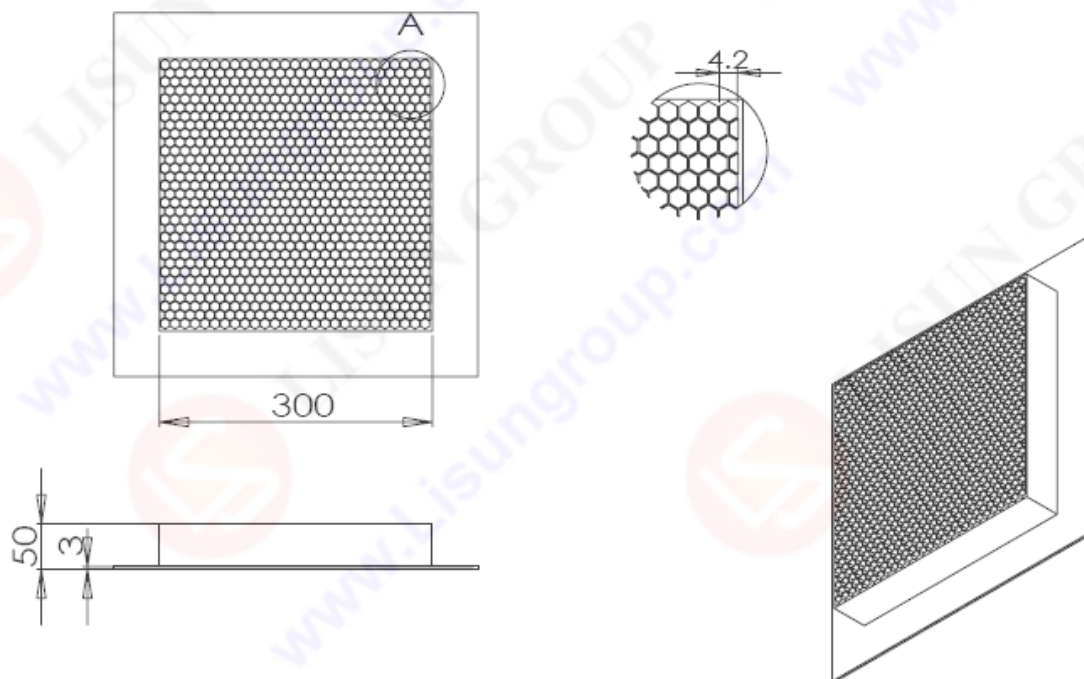

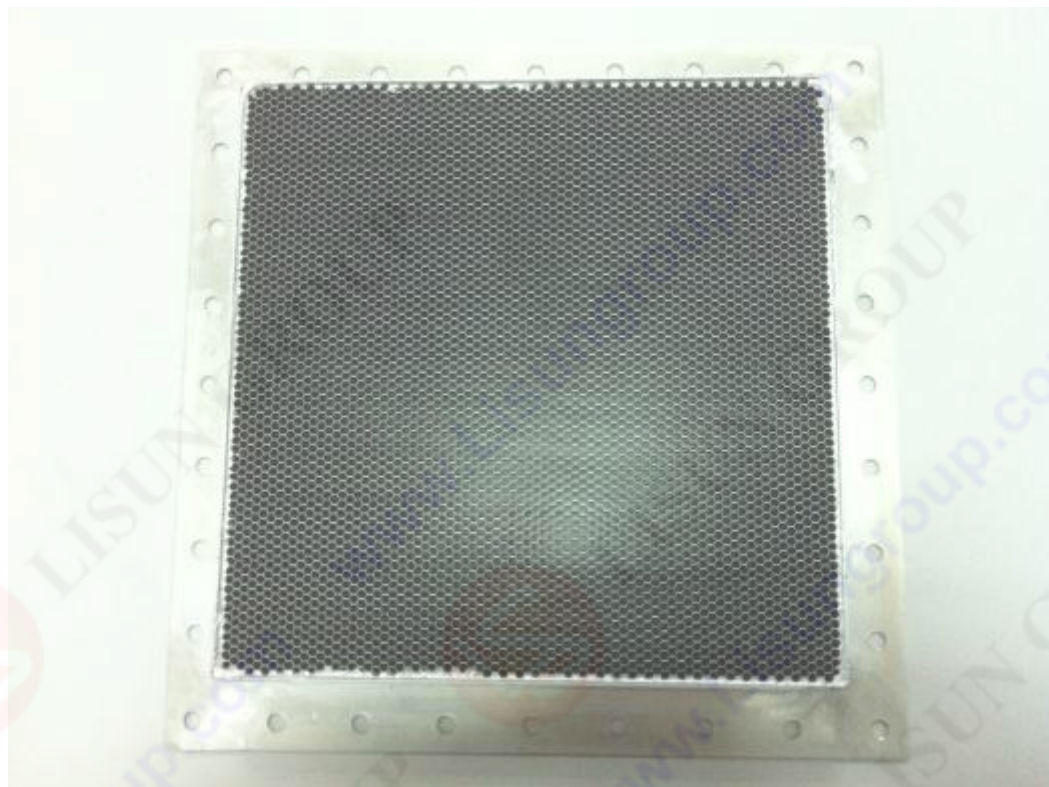

#### 4.4 Raised Floor

The entire radio frequency darkroom is equipped with a supported raised floor, with a height of 250mm, composed of high-density medium-density fiberboard, topped with a 3mm stainless steel plate for a smooth surface. There is good electrical connection between the steel plates, and they are well connected to the shielding enclosure. The load-bearing capacity can reach up to 1 ton per square meter.

#### 4.5 Signal Interface Panel

Copper signal interface panels are installed under the raised floor.

- Interface Panel Between the Darkroom and Control Room: The interface panel measures 470×170mm and is equipped with 4 SMA connectors, 4 BNC connectors, and 4 N connectors. Two waveguides with a diameter of  $\phi 30$ mm are installed on the panel.
- Interface Panel Between the Darkroom and Amplifier Room: The interface panel measures 470×170mm and is equipped with 4 SMA connectors, 2 BNC connectors, and 2 N connectors. One waveguide with a diameter of  $\phi 30$ mm is installed on the panel.
- Interface Panel Between the Control Room and Amplifier Room: The interface panel measures 470×170mm and is equipped with 4 SMA connectors, 4 BNC connectors, and 4 N connectors. Two waveguides with a diameter of  $\phi 30$ mm are installed on the panel.

- Interface Panel Between the Control Room and BCI Room: The interface panel measures 470×170mm and is equipped with 4 SMA connectors, 4 BNC connectors, and 4 N connectors. Two waveguides with a diameter of  $\phi 30\text{mm}$  are installed on the panel.
- Interface Panel Between the Interference Power Testing Room and Amplifier Room: The interface panel measures 470×170mm and is equipped with 4 SMA connectors, 2 BNC connectors, and 2 N connectors. One waveguide with a diameter of  $\phi 30\text{mm}$  is installed on the panel.



At the signal interface panel and power socket locations, ground interface boxes are installed.





#### 4.6 Laboratory Layout Diagram

Design according to the actual on-site conditions of the customer.

## Chapter 5: Auxiliary Equipment

### 5.1 EMC Testing Accessories for Power Equipment

Such as attenuators, cables, adapters, DC power supplies, universal meters, insulation resistance testers, leakage current testers, filters, hardware tools, and tool carts, etc.