



ANSI C78.81-2014

*American National Standard for
Electric Lamps—Double-Capped Fluorescent Lamps—
Dimensional and Electrical Characteristics*

www.Lisungroup.com

Secretariat:

National Electrical Manufacturers Association

Approved August 15, 2014

American National Standards Institute

NOTICE AND DISCLAIMER

The information in this publication was considered technically sound by the consensus of persons engaged in the development and approval of the document at the time it was developed. Consensus does not necessarily mean that there is unanimous agreement among every person participating in the development of this document.

ANSI standards and guideline publications, of which the document contained herein is one, are developed through a voluntary consensus standards development process. This process brings together volunteers and/or seeks out the views of persons who have an interest in the topic covered by this publication. While NEMA administers the process to promote fairness in the development of consensus, it does not write the document and it does not independently test, evaluate, or verify the accuracy or completeness of any information or the soundness of any judgments contained in its standards and guideline publications.

NEMA disclaims liability for any personal injury, property, or other damages of any nature whatsoever, whether special, indirect, consequential, or compensatory, directly or indirectly resulting from the publication, use of, application, or reliance on this document. NEMA disclaims and makes no guaranty or warranty, expressed or implied, as to the accuracy or completeness of any information published herein, and disclaims and makes no warranty that the information in this document will fulfill any of your particular purposes or needs. NEMA does not undertake to guarantee the performance of any individual manufacturer or seller's products or services by virtue of this standard or guide.

In publishing and making this document available, NEMA is not undertaking to render professional or other services for or on behalf of any person or entity, nor is NEMA undertaking to perform any duty owed by any person or entity to someone else. Anyone using this document should rely on his or her own independent judgment or, as appropriate, seek the advice of a competent professional in determining the exercise of reasonable care in any given circumstances. Information and other standards on the topic covered by this publication may be available from other sources, which the user may wish to consult for additional views or information not covered by this publication.

NEMA has no power, nor does it undertake to police or enforce compliance with the contents of this document. NEMA does not certify, test, or inspect products, designs, or installations for safety or health purposes. Any certification or other statement of compliance with any health or safety-related information in this document shall not be attributable to NEMA and is solely the responsibility of the certifier or maker of the statement

AMERICAN NATIONAL STANDARD

Approval of an American National Standard requires verification by ANSI that the requirements for due process, consensus, and other criteria for approval have been met by the standards developer.

Consensus is established when, in the judgment of the ANSI Board of Standards Review, substantial agreement has been reached by directly and materially affected interests. Substantial agreement means much more than a simple majority, but not necessarily unanimity. Consensus requires that all views and objections be considered, and that a concerted effort be made toward their resolution.

The use of American National Standards is completely voluntary; their existence does not in any respect preclude anyone, whether he has approved the standard or not, from manufacturing, marketing, purchasing, or using products, processes, or procedures not conforming to the standards.

The American National Standards Institute does not develop standards and will in no circumstances give an interpretation of any American National Standard. Moreover, no person shall have the right or authority to issue an interpretation of an American National Standard in the name of the American National Standards Institute. Requests for interpretations should be addressed to the secretariat or sponsor whose name appears on the title page of this standard.

CAUTION NOTICE: This American National Standard may be revised or withdrawn at any time. The procedures of the American National Standards Institute require that action be taken to reaffirm, revise, or withdraw this standard no later than five years from the date of approval. Purchasers of American National Standards may receive current information on all standards by calling or writing the American National Standards Institute.

Published by

National Electrical Manufacturers Association
1300 North 17th Street, Suite 900, Rosslyn, Virginia 22209

© 2014 National Electrical Manufacturers Association

All rights, including translation into other languages, reserved under the Universal Copyright Convention, the Berne Convention for the Protection of Literary and Artistic Works, and the International and Pan American copyright conventions.

No part of this publication may be reproduced in any form, in an electronic retrieval system or otherwise, without the prior written permission of the publisher.

Printed in the United States of America

Foreword (This foreword is not part of American National Standard C78.81-2014.)

Suggestions for improvement of this standard should be submitted to the Secretariat, C78 Committee, National Electrical Manufacturers Association, 1300 North 17th Street, Suite 900, Rosslyn, Virginia 22209.

This revision supersedes ANSI C78.81-2013.

This standard features the following revisions:

1. 17-Watt, 24-Inch T8, Fluorescent Lamp [7881-ANSI-1001-2]
2. 25-Watt 36-Inch T8, Fluorescent Lamp [7881-ANSI-1002-2]
3. 25-Watt 48-Inch T8, Fluorescent Lamp [7881-ANSI-1028-2]
4. 32-Watt 48-Inch T8, Fluorescent Lamp [7881-ANSI-1005-3]
5. 28-Watt, 48-Inch T8, Fluorescent Lamp [7881-ANSI-1029-2]
6. 30-Watt, 48-Inch T8, Fluorescent Lamp [7881-ANSI-1030-2]
7. 40-Watt, 60-Inch T8, Fluorescent Lamp [7881-ANSI-1007-2]
8. 59-Watt, 96-Inch T8, Single Pin Instant Start Fluorescent Lamp [7881-ANSI-1505-2]

This standard features the following [new] additions:

1. 15-Watt, 18-Inch T8, Fluorescent Lamp [7881-ANSI-1031-1]
2. 15-Watt, 24-Inch T8, Fluorescent Lamp [7881-ANSI-1032-1]
3. 21-Watt, 36-Inch T8, Fluorescent Lamp [7881-ANSI-1033-1]
4. 54-Watt, 96-Inch T8, Single Pin Instant Start Fluorescent Lamp [7881-ANSI-3015-1]

CONTENTS

	Page
Foreword.....	ii
1 Scope	1
1.1 Important Patent Disclaimer	1
2 General.....	1
3 Normative References	1
4 Definitions	2
5 Lamp Abbreviations	2
6 Methods of Measurement	2
7 Reference Ballasts	2
8 Product Drawings	3
9 Application of Lamps on More Than One Type of Circuit	3
10 Lamp Physical and Dimensional Requirements	3
10.1 Bulb Specifications	3
10.2 Base Specifications	3
10.3 Lamp Dimensions	3
10.3.1 Base Alignment of Finished Lamps	3
10.3.2 Base Alignment of Lamps with G5 Miniature Bipin Bases.....	3
10.3.3 Base Alignment of Lamps with G13 Medium Bipin Bases	3
10.3.4 Base Alignment of Lamps with R17d Recessed Double-Contact Bases	4
10.3.5 Base Alignment of Lamps with Fa8 Single Pin Bases.....	4
10.4 Color.....	5
11 Lamp Electrical Characteristics	5
11.1 Lamp Operating Characteristics	5
11.2 Lamp Starting Requirements	6
12 Requirements for Ballast Design.....	6
12.1 General	6
12.2 Lamp Starting Requirements	6
12.2.1 Voltage Between Lamp Terminals.....	7
12.2.2 Voltage from Lamp Terminal to Starting Aid	7
12.2.3 Wave Shape of Rapid-Start Starting Voltage	7
12.2.4 Starting Capacitor	7
12.3 Cathode Heating	7
12.4 Lamp Operating Current	8
12.4.1 Lamp Operating Current Limits	8
12.4.2 Operating Current Waveshape.....	8
12.5 Frequency to be Used for HF Operated Lamps	8

12.6	Lamp End Temperature Under Abnormal Conditions	8
13	Requirements for Luminaire Design	9
13.1	General	9
13.2	Starting aid	9
Annex A	Guide for Establishing Fluorescent Lamp Abbreviations	11
Annex B	Guidelines for the Establishment of Nominal Wattage Values on Fluorescent Lamp Data Sheets	14
Annex C	Bibliography.....	16
Annex D	USA Deviations to Adopted IEC Sheets	17

Tables

Table 1	Values of Dimension M and T	4
Table 2	Lamp Starting Requirements	6
Table 3	Ground Plane Distance.....	9
Table 4	Data Sheet List	19

www.Lisungroup.com

PART I—General Information and Requirements

1 Scope

This standard sets forth the physical and electrical characteristics of the principal types of fluorescent lamps intended for application on conventional line frequency circuits, and electronic high-frequency (HF) circuits. Some data sheets may specify more than one circuit application. Specifications for both the lamp itself and the interactive features of the lamp and ballast are given. Only double-based lamps of the regular linear shape are included. Single-based lamps, including compact, circular, square-shaped and U-shaped, are found in ANSI C78.901.

Lamps for conventional systems relying on auxiliary support from external ballasts are described. These lamps are those designed for 60 Hz and/or HF operation.

Lamp color is not specified herein.

Certain lamp types covered in this standard may be similar to those in IEC 60081. However, additional types are included that are used only in North America and are not specified in the IEC standard.

1.1 Important Patent Disclaimer

At the time of publication, it is possible that some of the elements of this document may be the subject of patent rights. When this Standard was approved for publication, the National Electrical Manufacturers Association (NEMA) did not know of any patent applications, patents pending, or existing patents. NEMA shall not be held responsible for identifying any or all such patent rights.

2 General

There are four parts to this standard:

- Part I** Contains requirements and general information. Detailed descriptions, references, and explanations of the terms used in the lamp data sheets are given. The principles of dimensioning lamps, both as finished lamps and for maximum outline purposes, are defined.
- Part II** Contains dimensioning principles and lamp outline drawings.
- Part III** Contains the annexes.
- Part IV** Contains the lamp data sheets for the lamp classes covered in this standard. Sheets adopted from IEC are not included, but a source reference is listed.

3 Normative References

The following standards contain provisions which, through reference in this text, constitute provisions of this American National Standard. At the time of publication, the editions indicated were valid. All standards are subject to revision, and parties to agreements based on this American National Standard are encouraged to investigate the possibility of applying the most recent editions of the standards indicated below.

ANSI C78.79-2014, *Nomenclature for Envelope Shapes Intended for Use with Electric Lamps*

ANSI C78.180-2003, *Specifications for Fluorescent Lamp Starters*

ANSI C78.375-1997, *Fluorescent Lamps - Guide for Electrical Measurements*

ANSI C78.376-2001, *Specifications for the Chromaticity of Fluorescent Lamps*

ANSI C81.61-2009, *Electric Lamp Bases*

ANSI C81.63-2009, *Gauges for Electric Lamp Bases and Lampholders*

ANSI C82.1-2004, *Lamp Ballast - Line frequency Fluorescent Lamp Ballast*

ANSI C82.3-2002, *Reference Ballasts for Fluorescent Lamps*

ANSI C82.11-2011, *High Frequency Fluorescent Lamp Ballasts*

ANSI C82.13-2002, *Definitions – for Fluorescent Lamps and Ballasts*

IEEE 100-2000, *Dictionary of Electrical and Electronics Terms*

ANSI/IEC C78.901-2005, *Electric Lamps – Fluorescent – Single-based Types - Dimensional and Electrical Characteristics*

ANSI/IEC C78.1195-2001, *Double-capped Fluorescent Lamps – Safety Specifications*

4 Definitions

For related definitions see ANSI C82.13 and the electrical dictionary ANSI/IEEE 100.

5 Lamp Abbreviations

Lamp abbreviations for fluorescent lamps are not officially assigned through any administered designation system. Those used on the data sheets are assigned in accordance with the Guidelines of Annex A. There is no requirement for the use of these abbreviations for lamp marking.

For some lamp types the referenced data sheet has been adopted from IEC publication 60081. These sheets do not contain a lamp abbreviation per Annex A. They are marked with an IEC designation code (ILCOS), but that code is not used in the USA.

6 Methods of Measurement

Electrical measurements necessary to determine the performance of lamps defined in this standard shall be made in accordance with the lamp measurements standard (ANSI C78.375).

7 Reference Ballasts

Reference ballasts used for measurements of fluorescent lamps shall meet the general requirements set forth in the reference ballast standard (ANSI C82.3). It should be noted that the reference ballast standard requires a power factor of 0.075 ± 0.005 for all fluorescent reference ballasts, unless otherwise specified on a lamp data sheet. Also, note that rapid-start reference ballasts called for in this standard include 3.6 V cathode heating.

8 Product Drawings

The drawings included in Part II are product drawings that show the applications of the various coded dimensions that appear on the data sheets. Drawings are only needed to depict families of lamps; the particular values vary within a family in accordance with the values on the relevant lamp data sheet.

No attempt has been made to provide maximum outline drawings to show the space occupied by the lamps. They are not provided because the need for such has not been established.

9 Application of Lamps on More Than One Type of Circuit

Lamp manufacturers may form an industry consensus approving the use of a particular lamp type on more than one type of circuit. In such cases, the lamp data sheet will show the information for all of the appropriate circuits.

10 Lamp Physical and Dimensional Requirements

10.1 Bulb Specifications

Each lamp data sheet in Part IV specifies the necessary bulb shape and tube diameter. Bulb shapes are defined in the bulb nomenclature standard (ANSI C79.1). Due to the long-established practice of referring to the diameter of fluorescent lamp bulbs in eighth-of-an-inch units, this standard maintains that practice. For example, a 1-inch diameter bulb is called a T8 bulb. Metric diameters in millimeters (mm) are shown in parentheses immediately following the customary designation.

10.2 Base Specifications

Bases on finished lamps shall comply with the standard sheets included in ANSI C81.61. Standard sheets for the gauges for checking bases are included in ANSI C81.63 and its supplements. For instant-start lamps with medium or mogul bipin bases, the pins are internally shorted. Some rapid-start lamps are used with HF instant-start ballasts. The pins of these lamps are not internally shorted.

10.3 Lamp Dimensions

10.3.1 Base Alignment of Finished Lamps

Finished lamps shall comply with the dimensions specified on the relevant data sheet in Part IV. Graphical definitions of the dimensional code letters used on the data sheets are given in Part II.

10.3.2 Base Alignment of Lamps with G5 Miniature Bipin Bases

Both pins (excluding flanges) of the two bases of an assembled lamp shall pass simultaneously without binding through parallel slots, each 0.113 in (2.87mm) in width, suitably spaced longitudinally to receive the lamp. The offset of the bulb with respect to the base axis shall comply with Table 1.

10.3.3 Base Alignment of Lamps with G13 Medium Bipin Bases

Both pins (excluding flanges) of the two bases of an assembled lamp shall pass simultaneously without binding through parallel slots, each 0.120 in (3.05mm) in width, suitably spaced longitudinally to receive the lamp. The offset of the bulb with respect to the base axis shall comply with Table 1.

10.3.4 Base Alignment of Lamps with R17d Recessed Double-Contact Bases

Both base bosses of an assembled lamp shall pass simultaneously without binding through parallel slots each 0.25 in (6.35mm) deep and 0.363 in (9.22mm) in width, suitably spaced longitudinally to receive the lamp with the bottoms of the slots against the boss ends. The offset of the bulb with respect to the base axis shall comply with Table 1.

10.3.5 Base Alignment of Lamps with Fa8 Single Pin Bases

The offset of the bulb with respect to the base axis is represented by dimension T described in Figure 1.

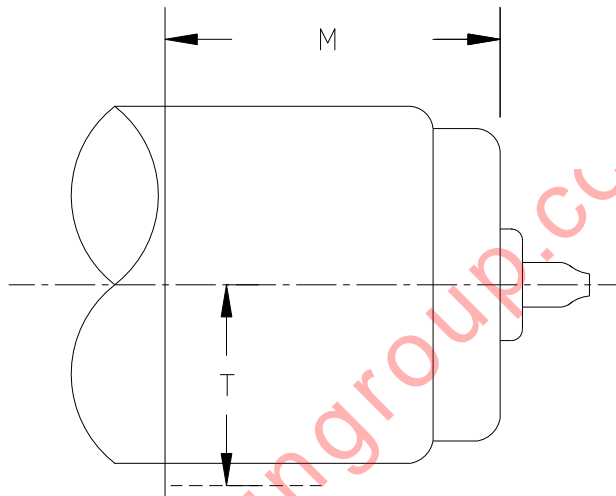

Figure 1

Table 1
Values of Dimension M and T

Base Type/ Bulb	Dimension M Minimum (Note 1)		Dimension T Maximum (Note 2)	
	inches	millimeters	inches	millimeters
Fa8 T6	1.25	31.75	0.430	10.92
	1.25	31.75	0.555	14.10
	1.25	31.75	0.800	20.32
	0.75	19.05	0.340	8.64
G13 T8	1.25	31.75	0.555	14.10
	1.25	31.75	0.680	17.27
	1.25	31.75	0.800	20.32
	2.0	50.8	1.110	28.19
R17d T12	1.25	31.75	0.800	20.32
	1.25	31.75	1.110	28.19
	1.25	31.75	1.110	28.19

NOTES—
 1 Represents length of lamp over which dimension T is applicable
 2 The T dimension includes allowance for possible offset of the bulb with respect to the base axis. This dimension is shown separately for various bulb diameters.

10.4 Color

Lamp colors are not specified in this standard. Lamp chromaticity is considered to be a variable within each particular type. Color coordinates for certain lamp types and certain colors are defined in the chromaticity standard (ANSI C78.376).

11 Lamp Electrical Characteristics

11.1 Lamp Operating Characteristics

The values of lamp voltage, current, and wattage shown on the individual lamp data sheets in Part IV are rated values that apply after the lamps have been aged for 100 hours. These values were chosen by consensus to represent the industry average at the time of publication. No manufacturer's average wattage shall exceed the rated value by more than 5% plus 0.5 watts. Fluorescent lamp operating characteristics are based on operation with a reference ballast (with cathode heating for rapid start characteristics) having the characteristics shown on the appropriate lamp data sheet and at an ambient temperature of 25°C, unless otherwise specified. Electrical characteristics and light output vary with ambient temperature.

Electrical measurements shall be made in accordance with ANSI C78.375.

11.2 Lamp Starting Requirements

Lamps shall start at the minimum starting voltages, within the wave shape limitation, as specified on each lamp data sheet under "Information for Ballast Design." Separate values apply for rapid or preheat (switch)–start operation. For preheat starting, a minimum preheat time is defined. This value is used for testing starters in accordance with ANSI C78.180.

The specified values are intended to provide reliable starting at the minimum ambient temperatures specified and above, up to a defined upper limit. Upper temperature limits depend upon ballast design and operating current as follows, unless otherwise specified on the lamp data sheets.

Table 2
Lamp Starting Requirements

Lamp operating Current	Ballast design	Upper temperature limit
<0.5A	All	110°F (43.3°C)
>0.5A	Single lamp	110°F (43.3°C)
>0.5A	2- or 3-lamp series	150°F (65.6°C)

At temperatures near the top of a range, however, initial starting will occur, but not necessarily immediate restarting.

12 Requirements for Ballast Design

12.1 General

Ballasts for use with the lamps in this standard shall meet the general requirements for fluorescent lamp ballasts as stated in the ballast standard (ANSI C82.1 or C82.11).

A ballast intended for use with a particular lamp type shall provide the lamp starting, cathode heating, and operating values specified on the relevant lamp data sheet in Part IV as defined in 12.2, 12.3, and 12.4. Requirements for rapid-, instant- (60 Hz low-frequency and HF electronic), preheat (switch)–, and HF electronic programmed-start ballasts are given in these sub clauses. Other special requirements may be specified on a lamp data sheet.

12.2 Lamp Starting Requirements

A commercial ballast designed to be used with a particular lamp type shall provide:

- a) the voltage between lamp terminals, and
- b) the voltage from lamp terminal to starting aid for 60 Hz low-frequency rapid start, and
- c) within the wave shape limitation as specified on the appropriate data sheet.

The specified voltage limits shall be provided at any line voltage between 90% and 110% of the ballast's rated input voltage. Additional information for ballast design concerning wave shape of starting voltage and starting capacitor sizes is specified on particular lamp data sheets.

12.2.1 Voltage Between Lamp Terminals

The limits shown on the appropriate lamp data sheets for 60 Hz low-frequency ballasts apply to the voltage to be supplied between those two lamp terminals that deliver the highest voltage. For series ballasts, the voltage is for two (or three) lamps in series.

For parallel-wired HF electronic instant-start and programmed-start ballasts, the voltage between terminals of any lamp must be equal to or exceed the specified limit. For multiple-lamp parallel-wired ballasts, the voltage across the last lamp to start (with lamps in all other positions) must be equal to or exceed the specified limit.

The voltage requirements must be provided at 90% or greater of the rated input voltage for the ballast.

12.2.2 Voltage from Lamp Terminal to Starting Aid

The limits shown on the lamp data sheets apply to the voltage to be supplied between a terminal (the one delivering the highest voltage) of each lamp and that part of the ballast that will be at a ground potential. At present, values shown in lamp data sheets apply only to 60 Hz low-frequency ballasts.

NOTE—Luminaires, however, must be at ground potential for all ballast types (see clause 13).

12.2.3 Wave Shape of Rapid-Start Starting Voltage

The maximum starting voltage crest factor value for all 60 Hz low-frequency rapid- and preheat (switch)–start lamps in this standard is 2.0, unless otherwise specified on the lamp data sheet. This applies to the voltage across the lamp and to the starting aid voltage, at 90-110% of rated ballast input voltage. There is no requirement for HF electronic ballasts.

12.2.4 Starting Capacitor

In a 60 Hz low-frequency two-lamp series, rapid-start ballast, the capacitor shall shunt the lamp farthest from ground potential.

In a 60 Hz low-frequency three-lamp series, rapid-start ballast, a capacitor shall shunt the two lamps farthest from ground potential. A second capacitor of the same size shall shunt the lamp farthest from ground. If the minimum peak voltage from lamp terminal–to–starting aid exceeds the specified limit by 30% or more, the second capacitor may shunt either of the two shunted lamps.

Appropriate capacitor sizes are specified on each lamp data sheet for 60 Hz low-frequency ballasts.

This requirement does not exist for HF electronic ballasts.

12.3 Cathode Heating

The specified voltage limits shall be provided at 90% and 110% of the ballast's rated input voltage, unless otherwise specified on the lamp data sheet.

For 60 Hz low-frequency rapid-start circuits, the required cathode heating voltage is specified on each lamp data sheet. Starting (dummy load) and operation limits are given.

In addition, the appropriate value of the dummy load resistor is specified as an aid to ballast design. Where one ballast winding operates two cathodes in parallel, the dummy load should be half the value given.

For preheat (switch)–start circuits, requirements for cathode heating current during the preheating phase and the preheat time are given on the appropriate lamp data sheet.

For HF electronic circuits, the requirements for cathode heating are provided on the lamp data sheets, if applicable.

12.4 Lamp Operating Current

12.4.1 Lamp Operating Current Limits

With rated voltage applied to the ballast, the maximum lamp current in a reference lamp shall be less than the following percentages of the current delivered to the same lamp by a reference ballast at its rated input voltage unless otherwise specified on the relevant lamp data sheet.

All electronic ballasts	107.5%
Magnetic switch-start ballasts	115%
Magnetic instant-start ballasts	120%
Magnetic rapid-start ballasts	115%

When ballasts are designed to operate more than one lamp, each circuit shall meet these requirements, both with and without lamps operating or preheating in the other circuit.

For HF electronic ballasts, a minimum lamp current without auxiliary cathode is also provided in the lamp data sheets.

12.4.2 Operating Current Waveshape

The wave shape of the lamp current supplied to a fluorescent lamp in a rapid-start or a preheat (switch)–start, line frequency circuit shall have a crest factor that does not exceed 1.70, unless otherwise specified on a lamp data sheet.

The wave shape of the lamp current supplied to a fluorescent lamp in an instant-start, line-frequency circuit shall have a crest factor that does not exceed 1.85, unless otherwise specified on a lamp data sheet.

The wave shape of the lamp current supplied by an HF ballast shall have a crest factor that does not exceed 1.70, unless otherwise specified.

12.5 Frequency to be Used for HF Operated Lamps

For lamps designed for operation on HF, the lamp data sheets prescribe a frequency or frequency range for the reference ballast and for the testing of lamps (starting, electrical, and photometric characteristics). This frequency or frequency range has been chosen for ease of reproducing test results and is not intended to restrict the design of HF ballasts where, for practical reasons, a higher frequency may be appropriate.

12.6 Lamp End Temperature Under Abnormal Conditions

The following applies to all HF electronic ballasts for lamps in this standard with a bulb diameter of T5 or less. In the case where a lamp does not start, any continuation of cathode heating shall not lead to overheating of the lamp ends. In the case where one of the electrodes is depleted or broken, while the lamp continues to operate (partial rectification), overheating of the lamp ends should be prevented by suitable measures in the circuit.

13 Requirements for Luminaire Design

13.1 General

A luminaire intended for use with a particular lamp type shall provide the appropriate starting aid of clause 13.2 if required, auxiliary supports if needed, and any specialized values that may appear on the relevant lamp data sheet in Part IV.

13.2 Starting aid

Operation of fluorescent lamps on 60 Hz low-frequency rapid-start circuits requires the presence of a grounded, conductive starting aid. This can be a conventional part of the luminaire. The starting aid shall be connected to electrical ground.

NOTE—This requirement does not apply for lamps with internal starting aids. External starting aids are not necessary for operation of such lamps.

Unless otherwise specified on a lamp data sheet, the surface of the starting aid shall be of a width at least equal to the diameter of the lamp or a minimum of 1 in (25mm) and extend essentially the full length of the lamp.

Unless otherwise specified on a lamp data sheet, distance from the lamp's bulb wall to the starting aid, as measured in a direction perpendicular to the surface of the starting aid, shall not be greater than the maximum distance shown in Table 3. In addition, given the potential presence of capacitive effects with HF electronic ballast operation, a minimum distance from the ground plane must also be defined:

Table 3
Ground Plane Distance

Type of Fluorescent Lamp	Maximum distance		Minimum distance (HF only)	
		mm	Inch	mm
T5 linear lamps	$\frac{1}{4}$	13	$\approx 1/8$	3mm
T8 linear lamps with RDC bases	$\frac{3}{4}$	19	TBD	TBD
All other linear lamps				
If rated 500 mA or less	$\frac{1}{2}$	13	TBD	TBD
If rated >500 mA	1	25	TBD	TBD
NOTES— Minimum distance requirements are for HF only. Lamps shall not contact the luminaire, lenses, or other lamps.				

PART II—Lamp Drawings and Dimensioning Principles

The diagrammatic drawings in this part give graphical definitions of the dimensional code letters used on the individual lamp data sheets. There are three major families of lamps depicted:

- a) G5, G13, G20 bipin bases, see Figure 1
- b) R17d recessed double-contact base, see Figure 2
- c) Fa8 base, see Figure 3

These drawings (figures 1-3) are intended to indicate only dimensions to be controlled and are to be used in conjunction with the relevant lamp data sheets.

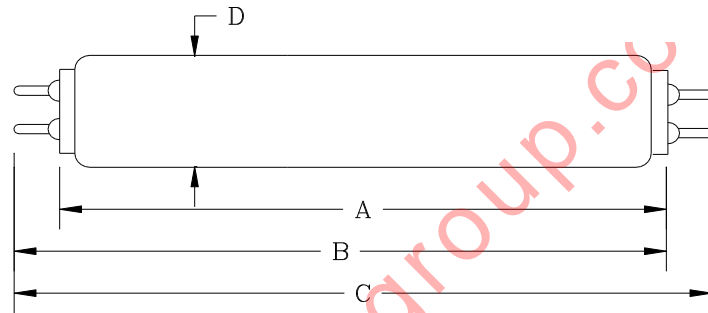

Figure 1 - Lamps with G5, G13, G20 bipin bases

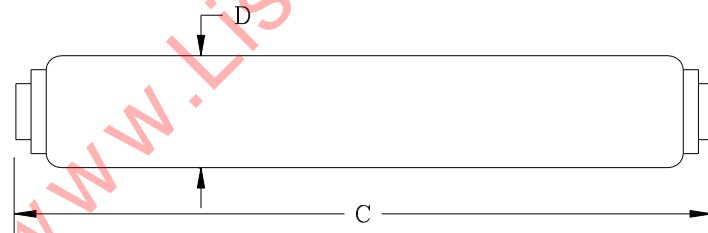

Figure 2 - Lamps with R17d recessed double-contact base

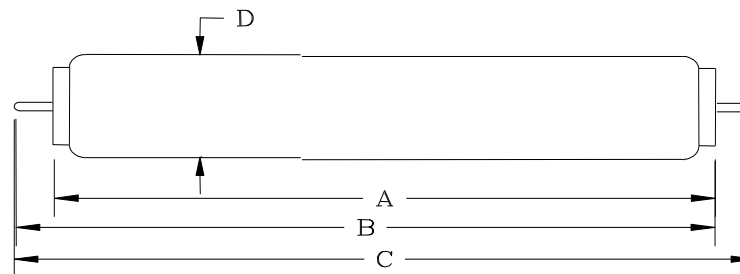

Figure 3 - Lamps with Fa8 Base

PART III—Annexes

Annex A Guide for Establishing Fluorescent Lamp Abbreviations (Informative)

A.1 General

There is a need to identify lamp abbreviations for the lamps in this standard. These abbreviations will benefit users of the fluorescent lamp data sheets. A lamp, in this abbreviation system, is identified by wattage, length or shape, bulb size, and circuit application.

This guide is intended to provide a set of rules for reference in deriving abbreviations for lamp data sheets in a consistent manner. There is no implication that abbreviations derived from this system are to be used or required for commercial literature applications.

A.2 Abbreviation

Only one abbreviation, under this system, is to be applied to a lamp data sheet. No attempt is made to identify lamp colors.

An abbreviation is comprised of six parts:

- a) lamp nominal wattage;
- b) lamp nominal length;
- c) bulb diameter;
- d) lamp shape, as required;
- e) lamp base, as required; and
- f) circuit or special description, or both.

The parts of the abbreviation are joined directly together in the above sequence and slashes are used as separators after wattage, bulb diameter, and the lamp shape or lamp base, if used. A hyphen may be used if two properties are identified under item (f) above. Otherwise, there are no spaces or other separator marks used.

A.2.1 Wattage

All lamps shall be identified by wattage, even though they may not be marketed by wattage. The wattage values shown shall be the rated or nominal wattage of the lamp. The numerical value of wattage in watts shall be followed directly by the letter "W."

A.2.2 Length

The length of a linear lamp shall be expressed in the designation by a number representing the nominal length of the lamp, in inches. Only the numerical value is entered. This length code is based upon a first-order assumption that fluorescent lamps are linear lamps.

For those special cases in which it is necessary to identify lamp length in metric units, the abbreviations shall contain the letters "mm" immediately following the length value in millimeters.

A.2.3 Bulb diameter

Bulb diameter shall be entered directly following the length without any separator. The bulb diameter information comprises two sub-parts. The first part is a letter to indicate the bulb's cross-sectional shape. The bulb shape is identified by a letter symbol as follows:

- T Round cross-sectional tubular bulb
- PG Power groove indented bulb

The second part is the bulb diameter. Values shall be entered in the conventional eighths-of-an-inch system.

For those special cases in which it is necessary to identify bulb diameter in metric units, the abbreviation shall contain the letters "mm" immediately following the diameter value in millimeters.

A.2.4 Lamp shape

All lamps in this standard are linear.

A.2.5 Lamp base

The lamp's base code may be used as part of the abbreviation in certain cases. Those are the cases where the application of the lamp to the correct auxiliary circuit is controlled by means of the base on the lamp. Proper base codes are noted in the base standard (ANSI C81.61).

A.2.6 Circuit or special description, or both

This part of the abbreviation shall follow the slashed separator, which follows the bulb diameter or the optional shape and base information when they are provided. It is intended to help the user associate the lamp with the correct auxiliary circuit.

This abbreviation system does not necessarily identify all circuits that a lamp manufacturer may have authorized for use with a particular lamp.

Lamps that are specified for operation at two separate wattage or current levels, on the same type of circuit, are identified in the abbreviation by the lower level only.

Typical circuit identifiers:

- RS Rapid start
- PH Preheat start (starter)
- IS Bipin base, instant start
- PS Programmed start
- SP Single-pin base, instant start
- HF High frequency
- HO 800 mA and 1000 mA, high output, rapid start
- 1.5A 1500 mA, rapid start

Special descriptions may be necessary in certain cases to separate lamps of similar design. These special identifiers may be used in addition to the above circuit identifications, separated by a hyphen. Special descriptions are defined as follows:

- B Bactericidal lamp
- CC Cold cathode
- LP Low pressure
- HP High pressure

A.3 Sample abbreviations

The following table contains several sample abbreviations with explanations:

<u>Abbreviations</u>	<u>Lamp Explanation</u>
30W/36T12/RS	30-watt, 36-inch T12, rapid-start
215W/96T12/1.5A	215-watt, 96-inch T12, 1500 mA, rapid-start
37W/24T12/HO	37-watt, 24-inch T12, high-output, rapid-start
116W/48T12/1.5A	116-watt, 48-inch T12, 1500 mA, rapid-start
116W/48PG17/1.5A	116-watt, 48-inch PG17, 1500 mA, rapid-start
4W/6T5/PH	4-watt, 6-inch T5, preheat-start
30W/36T8/PH-B	30-watt, 36-inch T8, preheat-start, bactericidal
40W/60T12/IS	40-watt, 60-inch T12, bipin base, instant-start
75W/96T12/SP	75-watt, 96-inch T12 single pin, instant-start

Annex B
Guidelines for the Establishment of Nominal Wattage Values
on Fluorescent Lamp Data Sheets
(Informative)

B.1 Introduction

A typical ANSI lamp data sheet for a fluorescent lamp type shows values for both a wattage identification value (nominal wattage) and a lamp operating characteristic wattage (rated wattage). While “nominal wattage” is assigned for identification purposes, the “rated wattage” is a value used for the evaluation of results under specific measurement conditions. Since each has a separate purpose, there is no need for them to agree absolutely. However, wide disagreement could provide questions and might be misleading to readers.

These guidelines should be applied to new lamp types being standardized. They are not to be applied retroactively.

B.2 Purpose

The purpose of this appendix is to provide guidelines for the establishment of nominal wattage identification of a fluorescent lamp data sheet, relative to its associated rated wattage value.

B.3 Various Factors Affecting Nominal Wattage

B.3.1 Application Circuit

Early in the history of the development of fluorescent lamps, preheat (switch)–start circuits were used exclusively. Later, rapid-start and instant-start circuits became important also. Presently, additional circuits, such as modified rapid-start, high-frequency (HF) switch-start, and HF rapid-start are coming into use.

Although a type of fluorescent lamp may be designed for operation on one specific circuit, that lamp may be later applied on another circuit(s). Therefore, one particular type of fluorescent lamp might be utilized on one of several different auxiliary circuits. The operating power dissipation of a lamp can be expected to vary depending on the circuit in which it is used.

An overly complicated situation would occur if a lamp’s nominal wattage value reflected the operational results of several different circuits. The more straightforward, simplified approach is the assignment of nominal wattage, regardless of various applications.

B.3.2 Measurements of Lamp Characteristics on Reference Ballast

Measurements of fluorescent lamps have always been made on reference ballast circuits. Lamp characteristics, including characteristic wattage, are then specified on the lamp data sheet relative to the measurements on the specified reference ballast.

Switch-start reference circuits or rapid-start reference circuits are specified in various ANSI standards. The difference between them is that the latter incorporates continuous cathode heating. Numerically, for the same lamp type, this would normally amount to a wattage difference of less than 5%. Reference circuits for HF operation have not yet been fully developed. Where rapid-start lamp operating characteristics are given, both switch-start and rapid-start characteristics are really present. The terms used are arc wattage, which is analogous to operation on a switch-start reference ballast, and total wattage, which includes cathode wattage and thus represent operation on a rapid-start reference ballast.

With the above two sets of lamp characteristics available, it is not always clear whether “arc wattage” or “total wattage” should be the basis for the “nominal wattage.”

B.3.3 Hierarchy of Lamp Characteristics

When switch-start was the first application for a lamp, the nominal wattage value would have been established in relation to that original switch-start data. Once established, no change would be made when new applications and additional reference ballast conditions were added. Any change in identification of a specific lamp would be confusing to the consumers. Conversely, a lamp originally developed for use on rapid-start circuits would be assigned a nominal wattage relative to lamp characteristics on the rapid-start reference ballast. A dilemma occurs, however, when both applications for the same lamp type have commercial importance.

In one sense, basing a lamp’s nominal wattage on a switch-start specification can be misleading to customers who operate the lamp on a rapid-start circuit. The identification based on switch-start specifications is further removed from the actual power consumption for the rapid-start application. The reverse is also true. Therefore, it will be beneficial to all if a fixed procedure for assignment of nominal wattage is established so that uncertainties are eliminated.

B.4 Procedure for Establishing Nominal Wattage

B4.1 For lamp types intended only for application on rapid-start circuits, or where rapid start is the only known application when the lamp data is first approved, the nominal wattage shall be based on the rapid-start rated wattage (total wattage, including cathode heating wattage).

B4.2 For lamp types intended for use on more than one type of circuit, the nominal wattage shall be based on the most commonly used commercial circuits.

B4.3 A nominal wattage value may be rounded to the nearest appropriate value.

Annex C
Bibliography
(Informative)

ANSI C78.5-2003, *Electric Lamps - Fluorescent Lamps - Performance Guide*

ANSI C82.2-2002, *Fluorescent Lamp Ballasts - Methods of Measurement*

IEC 60081-1997, *Double-capped Fluorescent Lamps – Performance Specifications*

www.Lisungroup.cc

Annex D
USA Deviations to Adopted IEC Sheets
(Normative)

T5 linear lamps for HF operation

The following data sheets were adopted with an exception to the starting requirements without cathode preheating in the *Information for ballast design* section of the sheet. These starting requirements are excluded. Starting requirements for this mode of operation (also known as instant start) are under consideration.

60081-IEC-6520-3

60081-IEC-6530-3

60081-IEC-6620-2

60081-IEC-6640-3

60081-IEC-6650-3

60081-IEC-6730-2

60081-IEC-6750-2

60081-IEC-6840-2

60081-IEC-6850-2

www.Lisungroup.cc

PART IV—Lamp Specification Data Sheets

1 General Principals for Numbering of Data Sheets

The first number represents the number of this standard “7881” followed by the letters “ANSI.” For data sheets adopted from IEC, the IEC number will be retained and would start with “60081-IEC” or the like.

The second number is the data sheet number.

The third number represents the edition of the page of the data sheet. In cases where the data sheet has more than one page, it is possible for the pages to have different edition numbers, with the data sheet number remaining the same.

2 Data Sheet List and Sequence

The following page presents a list of all the data sheets. The list is sorted in the order of circuit, then bulb diameter, then wattage, and then length. Sheets adopted from the IEC are identified with an asterisk (*) preceding the sheet number. Use this list to identify the data sheet number of the lamp. The ANSI data sheets follow in order of the sheet number.

The data sheets adopted from IEC publication 60081 are not included in this standard. They must be purchased separately.

IEC standards such as 60081 are available from:

American National Standards Institute
Attn: eStandard Store
25 West 42nd Street, 4th Floor
New York, NY 10036

or by calling (212) 642-4900 during normal business hours. Standards may also be purchased electronically at the following URLs:

www.ansi.org or <http://webstore.ansi.org/ansidocstore/default.asp>

3 Deviations to adopted IEC data sheets

USA deviations may be specified for adopted IEC data sheets. Deviations are listed in Annex D of this standard.

**Table 4
Data Sheet List**

Data Sheet Number 7881-ANSI-	Nominal Wattage (W)	Nominal length (Inch)	Bulb	Base	Reference Frequency (Hz)	Circuit/ Notes
1001-2	17	24	T8	G13	25k	IS/PS/RS
1002-2	25	36	T8	G13	25k	IS/PS/RS
1003-1	25	36	T12	G13	60	RS
1004-1	30	36	T12	G13	60	RS
1005-3	32	48	T8	G13	25k	IS/PS/RS
1006-1	34	48	T12	G13	60	RS
1007-2	40	60	T8	G13	25k	IS/PS/RS
1008-1	40	48	T10	G13	60	RS
1009-1	40	1160mm	T12	G13	60	RS
1010-1	40	48	T12	G13	60	RS
1011-1	37	24	T12	RDC	60	RS-.800A
1012-1	50	36	T12	RDC	60	RS-.800A
1013-1	63	48	T12	RDC	60	RS-.800A
1014-1	75	60	T12	RDC	60	RS-.800A
1015-1	87	72	T12	G20	60	RS-.800A
1016-1	87	72	T12	RDC	60	RS-.800A
1017-1	95	96	T12	RDC	60	RS-.800A
1018-1	100	84	T12	RDC	60	RS-.800A
1019-1	113	96	T12	RDC	60	RS-.800A
1021-1	116	48	T12	RDC	60	RS-1.5A
1022-1	116	48	PG17	RDC	60	RS-1.5A
1023-1	168	72	T12	RDC	60	RS-1.5A
1024-1	168	72	PG17	RDC	60	RS-1.5A
1025-1	215	96	T12	RDC	60	RS-1.5A
1026-1	215	96	PG17	RDC	60	RS-1.5A
1027-1	25	48	T12	G13	60	RS/PH-shoplight
1028-2	25	48	T8	G13	25k	IS/PS
1029-2	28	48	T8	G13	25k	IS/PS
1030-2	30	48	T8	G13	25k	IS/PS
1031-1	15	18	T8	G13	25k	IS/PS/RS
1032-1	15	24	T8	G13	25k	IS/PS
1033-1	21	36	T8	G13	25k	IS/PS
1501-1	86	96	T8	R17d	25k	RS/PH/PS
1502-1	44	48	T8	R17d	25k	RS/PH/PS

Data Sheet Number 7881-ANSI-	Nominal Wattage (W)	Nominal length (Inch)	Bulb	Base	Reference Frequency (Hz)	Circuit/ Notes
1503-1	56	60	T8	R17d	25k	RS/PH/PS
1504-1	66	72	T8	R17d	25k	RS/PH/PS
1505-2	59	96	T8	Fa8	25k	IS
2001-1	4	6	T5	G5	60	PH
2002-1	6	9	T5	G5	60	PH
2003-1	8	12	T5	G5	60	PH
2004-1	8	12	T5	G5	60	PH/Bactericidal
2005-1	13	21	T5	G5	60	PH
2006-1	14	15	T8	G13	60	PH
2007-1	14	15	T12	G13	60	PH
2008-1	15	18	T8	G13	60	PH
2009-1	15	18	T8	G13	60	PH/Bactericidal
2010-1	15	18	T12	G13	60	PH
2011-1	18	24	T8	G13	60	PH
2012-1	18	26	T8	G13	60	PH
2013-1	19	28	T8	G13	60	PH
2014-1	19	30	T8	G13	60	PH
2015-1	20	24	T12	G13	60	PH
2016-1	25	28	T12	G13	60	PH
2017-1	25	33	T12	G13	60	PH
2018-1	30	36	T8	G13	60	PH
2019-1	30	36	T8	G13	60	PH/Bactericidal
2020-1	90	60	T12	G20	60	PH
2021-1	90	60	T17	G20	60	PH
3001-1	40	48	T12	G13	60	IS
3002-1	40	60	T12	G20	60	IS
3003-1	40	60	T17	G20	60	IS
3004-1	40	48	T12	Fa8	60	IS
3005-1	57	72	T12	Fa8	60	IS
3006-1	60	96	T12	Fa8	60	IS
3007-1	75	96	T12	Fa8	60	IS
3008-1	25	42	T6	Fa8	60	IS
3009-1	38	64	T6	Fa8	60	IS
3010-1	38	72	T8	Fa8	60	IS
3011-1	51	96	T8	Fa8	60	IS
3012-1		45	T8	Cap	60	Cold cathode

Data Sheet Number 7881-ANSI-	Nominal Wattage (W)	Nominal length (Inch)	Bulb	Base	Reference Frequency (Hz)	Circuit/ Notes
3013-1		69	T8	Cap	60	Cold cathode
3014-1		93	T8	Cap	60	Cold cathode
3015-1	54	96	T8	Fa8	25k	IS
*6520-3	14	550mm	T5	G5	≥20k	HF/note USA deviation
*6530-3	21	850mm	T5	G5	≥20k	HF/note USA deviation
*6620-2	24	550mm	T5	G5	≥20k	HF/note USA deviation
*6640-3	28	1150mm	T5	G5	≥20k	HF/note USA deviation
*6650-3	35	1450mm	T5	G5	≥20k	HF/note USA deviation
*6730-2	39	850mm	T5	G5	≥20k	HF/note USA deviation
*6750-2	49	1450mm	T5	G5	≥20k	HF/note USA deviation
*6840-2	54	1150mm	T5	G5	≥20k	HF/note USA deviation
*6850-2	80	1450mm	T5	G5	≥20k	HF/note USA deviation

*adopted from IEC 60081. The prefix for this sheet is 60081-IEC-
See Annex D of this standard for USA deviations to adopted sheet.

This page intentionally left blank

www.Lisungroup.cc

17-Watt, 24-Inch T8 Fluorescent Lamp

Lamp Description

Lamp abbreviation	17W/24T8
Nominal wattage	17 watts
HF reference wattage	15 watts
Nominal overall length	24 in (600mm)
Bulb designation	T8 (T25)
Base	G13, Medium bipin
Circuit application	Instant start, Programmed start, Rapid start

NOTE—The “nominal wattage” of 17W for this lamp reflects common commercial nomenclature. It represents the measured wattage on a 60 Hz reference ballast for 17W/24T8/RS fluorescent lamps. The high frequency (HF) reference wattage of 15W above reflects the measured wattage when operated on the HF reference ballast.

Dimensional characteristics (definitions of Part II apply)

	Inches		Millimeters	
	Min	Max	Min	Max
A (Base face to base face)	-	23.22	-	589.8
B (Base face to end of opposite base pin)	23.40	23.50	594.4	596.9
C (End of base pin to end of opposite pin end)	23.67	23.78	601.2	604.0
D (Bulb, outside diameter)	0.94	1.10	23.9	27.9

Cathode characteristics (for heated-cathode starting methods)

Type	Low resistance
Resistance at 3.6 V	12.0 ± 2.0 ohms
R _h /R _c ratio at 3.6 V	4.75 ± 0.50

7881-ANSI-1001-2

© 2014 National Electrical Manufacturers Association

Electrical Characteristics (with a 25 kHz reference ballast)

Typical lamp electrical characteristics without coil heat will be as follows when the lamp is operated at 25 kHz with a resistive ballast. This represents a reference ballast circuit for HF operation. The following characteristics set the “rated wattage” for this lamp type. The HF reference ballast is specified to provide approximately the same lamp light output as when it is operated on a 60 Hz measurement ballast for 17W/24T8/RS fluorescent lamps with cathode heat.

Typical lamp operating characteristics (conditions of clause 11 apply)

Wattage (W)	15.1
Voltage (V)	68

Reference ballast characteristics

Typical input voltage (V)	407
Current (A)	0.225
Impedance (ohms)	1500
Frequency (kHz)	25

NOTE—The reference ballast characteristics are normative, and lamp current should be set to the indicated value during photometric and electrical measurements per the ANSLG C82.2, C82.3 and C78.375 standards. No cathode heat is applied for the HF reference measurements. The lamp operating characteristics are typical of average lamp performance on the reference ballast.

7881-ANSI-1001-2

© 2014 National Electrical Manufacturers Association

**17-Watt, 24-Inch T8
Fluorescent Lamp
Page 3 of 5**

Information for HF ballast design (conditions of clause 12 apply)

Lamp current limits

Minimum design lamp current without cathode heat, I_{rms} (A)	0.155
Maximum design lamp current, I_{rms} (A)	0.320
Maximum lamp current crest factor	1.7

NOTE—Ballasts designed for lamps without cathode heating shall have a design minimum lamp current around 0.155 A. Variation around this design value due to potential tolerances related to components and manufacturing is expected. However, the lamp current shall not be less than 0.140 A under any condition without cathode heating. Further, the lamp current shall not exceed 0.335 A under any operating condition.

Instant start requirements

For lamp use on HF instant-start electronic ballasts. The requirements shall be met at any primary voltage between 90% and 110% of ballast's rated input voltage.

Lamp starting requirements

Open circuit voltage (min), V_{rms} , $T_{amb} \geq 50^{\circ}F$	465
Open circuit voltage (min), V_{rms} , $-20^{\circ}F \leq T_{amb} < 50^{\circ}F$	600
Maximum starting time (ms)	100

Programmed start requirements

For lamp use with HF programmed-start ballasts.

Lamp starting requirements

Preheating time	$0.4 \leq t \leq 1.5$ s
R_h/R_c limits defined by	$4.25 \leq R_h/R_c \leq 6.0$
Open circuit voltage (min), V_{rms} , $T_{amb} \geq 50^{\circ}F$	Under consideration

During preheating

Cathode heating voltage (max), V_{rms}	10
Voltage crest factor (max)	1.7
Lamp glow current (max), I_{rms} (A)	0.010

7881-ANSI-1001-2

© 2014 National Electrical Manufacturers Association

Rapid start requirements

For lamp use with HF rapid-start ballasts. The following limit is to be observed during the starting period. The requirements of C82.11 section 5.2.3 apply.

Cathode heat requirements

Voltage maximum during operation, V_{rms} 5.3 V

Information for dimming ballast design (Effective January 1, 2015)

For operation at reduced lamp current, the cathode requires supplemental ohmic heating by means of circulating current in the cathode. The following are specifications for the voltage drop, EV , across each cathode in a system of one or more lamps for a range of lamp current, I_D , in dimmed operation.

Maximum heating voltage (V):	$EV_{max} = 5.3$	
Minimum heating voltage (V):	$EV_{min} = 4.0$	for $0.020 \leq I_D < 0.050$ (A)
	$EV_{min} = 5.0 - 20 * I_D$	for $0.050 \leq I_D < 0.100$ (A)
	$EV_{min} = 8.45 - 54.5 * I_D$	for $0.100 \leq I_D < 0.155$ (A)
	$EV_{min} = 0$	for $0.155 \leq I_D$ (A)

7881-ANSI-1001-2

© 2014 National Electrical Manufacturers Association

**17-Watt, 24-Inch T8
Fluorescent Lamp
Page 5 of 5**

Information for 60 Hz ballast operation

The following information pertains to the former 17W/24T8/RS lamp specification. It is preserved here to allow a smooth transition from operation on 60 Hz ballasts to HF electronic ballasts. Whenever practical, the HF specifications should be used.

Rapid start requirements

	<u>Single lamp</u>	<u>Ballasts for two lamps</u>
Rapid start		
Voltage between lamp terminals (Note 1)		
at 50°F (10°C) and above, (V_{rms}) min	140	210
at 50°F (10°C) and above, (V_{rms}) max	190	285
Voltage lamp terminal to starting aid (Note 2)		
at 50°F (10°C) and above, (V_{peak}) min	325	325
Waveshape of starting voltage crest factor, max	2.0	2.0
Starting capacitor size		
min (μ F) (at 60 Hz)		0.04
max (μ F) (at 60 Hz)		0.06

NOTES—

- 1 These values are for lead circuits only. Values for lag circuits are under consideration.
- 2 These values are for crest factors of 1.55 to 2.0. Add 20% for crest factors less than 1.55.

Cathode heat requirements – Rapid start

Voltage	3.6 V nominal
Limits during operation	2.5 V min, 4.4 V max
Dummy load resistor	11.0 ohms \pm 0.1 ohm
Voltage across dummy load	3.4 V min, 4.5 V max

7881-ANSI-1001-2

© 2014 National Electrical Manufacturers Association

25-Watt, 36-Inch T8 Fluorescent Lamp

Lamp Description

Lamp abbreviation	25W/36T8
Nominal wattage	25 watts
HF reference wattage	22 watts
Nominal overall length	36 in (900mm)
Bulb designation	T8 (T25)
Base	G13, Medium bipin
Circuit application	Instant start, Programmed start, Rapid start

NOTE—The “nominal wattage” of 25W for this lamp reflects common commercial nomenclature. It represents the measured wattage on a 60 Hz reference ballast for 25W/36T8/RS fluorescent lamps. The high-frequency (HF) reference wattage of 22W above reflects the measured wattage when operated on the HF reference ballast.

Dimensional characteristics (definitions of Part II apply)

	<u>Inches</u>		<u>Millimeters</u>	
	<u>Min</u>	<u>Max</u>	<u>Min</u>	<u>Max</u>
A (Base face to base face)	-	35.22	-	894.6
B (Base face to end of opposite base pin)	35.40	35.50	899.2	901.7
C (End of base pin to end of opposite pin end)	35.67	35.78	906.0	908.8
D (Bulb, outside diameter)	0.94	1.10	23.9	27.9

Cathode characteristics (for heated-cathode starting methods)

Type	Low resistance
Resistance at 3.6 V	12.0 ± 2.0 ohms
R _h /R _c ratio at 3.6 V	4.75 ± 0.50

7881-ANSI-1002-2

© 2014 National Electrical Manufacturers Association

**25-Watt, 36-Inch T8
Fluorescent Lamp
Page 2 of 5**

Electrical Characteristics (with a 25 kHz reference ballast)

Typical lamp electrical characteristics without coil heat will be as follows when the lamp is operated at 25 kHz with a resistive ballast. This represents a reference ballast circuit for HF operation. The following characteristics set the “rated wattage” for this lamp type. The HF reference ballast is specified to provide approximately the same lamp light output as when it is operated on a 60 Hz measurement ballast for 25W/36T8/RS fluorescent lamps with cathode heat.

Typical lamp operating characteristics (conditions of clause 11 apply)

Wattage (W)	22.4
Voltage (V)	103

Reference ballast characteristics

Typical input voltage (V)	430
Current (A)	0.218
Impedance (ohms)	1500
Frequency (kHz)	25

NOTE—The reference ballast characteristics are normative, and lamp current should be set to the indicated value during photometric and electrical measurements per the ANSLG C82.2, C82.3 and C78.375 standards. No cathode heat is applied for the HF reference measurements. The lamp operating characteristics are typical of average lamp performance on the reference ballast.

7881-ANSI-1002-2

© 2014 National Electrical Manufacturers Association

Information for HF ballast design (conditions of clause 12 apply)

Lamp current limits

Minimum design lamp current without cathode heat, I_{rms} (A)	0.155
Maximum design lamp current, I_{rms} (A)	0.320
Maximum lamp current crest factor	1.7

NOTE—Ballasts designed for lamps without cathode heating shall have a design minimum lamp current around 0.155 A. Variation around this design value due to potential tolerances related to components and manufacturing is expected. However, the lamp current shall not be less than 0.140 A under any condition without cathode heating. Further, the lamp current shall not exceed 0.335 A under any operating condition.

Instant start requirements

For lamp use on HF instant-start electronic ballasts. The requirements shall be met at any primary voltage between 90% and 110% of ballast's rated input voltage.

Lamp starting requirements

Open circuit voltage (min), V_{rms} , $T_{amb} \geq 50^{\circ}F$	465
Open circuit voltage (min), V_{rms} , $-20^{\circ}F \leq T_{amb} < 50^{\circ}F$	600
Maximum starting time (ms)	100

Programmed start requirements

For lamp use with HF programmed-start ballasts.

Lamp starting requirements

Preheating time	$0.4 \leq t \leq 1.5$ s
R_h/R_c limits defined by	$4.25 \leq R_h/R_c \leq 6.0$
Open circuit voltage (min), V_{rms} , $T_{amb} \geq 50^{\circ}F$	Under consideration

During preheating

Cathode heating voltage (max), V_{rms}	10
Voltage crest factor (max)	1.7
Lamp glow current (max), I_{rms} (A)	0.010

7881-ANSI-1002-2

© 2014 National Electrical Manufacturers Association

**25-Watt, 36-Inch T8
Fluorescent Lamp
Page 4 of 5**

Rapid start requirements

For lamp use with HF rapid-start ballasts. The following limits are to be observed during the starting period. The requirements of C82.11 section 5.2.3 apply.

Cathode heat requirements

Voltage maximum during operation, V_{rms} 5.3 V

Information for dimming ballast design (Effective January 1, 2015)

For operation at reduced lamp current, the cathode requires supplemental ohmic heating by means of circulating current in the cathode. The following are specifications for the voltage drop, EV , across each cathode in a system of one or more lamps for a range of lamp current, I_D , in dimmed operation.

Maximum heating voltage (V):	$EV_{max} = 5.3$	
Minimum heating voltage (V):	$EV_{min} = 4.0$	for $0.020 \leq I_D < 0.050$ (A)
	$EV_{min} = 5.0 - 20 * I_D$	for $0.050 \leq I_D < 0.100$ (A)
	$EV_{min} = 8.45 - 54.5 * I_D$	for $0.100 \leq I_D < 0.155$ (A)
	$EV_{min} = 0$	for $0.155 \leq I_D$ (A)

7881-ANSI-1002-2

© 2014 National Electrical Manufacturers Association

Information for 60 Hz ballast operation

The following information pertains to the former 25W/36T8/RS lamp specification. It is preserved here to allow a smooth transition from operation on 60 Hz ballasts to HF electronic ballasts. Whenever practical, the HF specifications should be used.

Rapid start requirements

	<u>Single lamp</u>	<u>Ballasts for two lamps</u>
Rapid start		
Voltage between lamp terminals (Note 1)		
at 50°F (10°C) and above, (V_{rms}) min	170	260
at 50°F (10°C) and above, (V_{rms}) max	230	355
Voltage lamp terminal to starting aid (Note 2)		
at 50°F (10°C) and above, (V_{peak}) min	325	325
Waveshape of starting voltage crest factor, max	2.0	2.0
Starting capacitor size		
min (μ F) (at 60 Hz)		0.04
max (μ F) (at 60 Hz)		0.06

NOTES—

- 1 These values are for lead circuits only. Values for lag circuits are under consideration.
- 2 These values are for crest factors of 1.55 to 2.0. Add 20% for crest factors less than 1.55.

Cathode heat requirements – Rapid start

Voltage	3.6 V nominal
Limits during operation	2.5 V min, 4.4 V max
Dummy load resistor	11.0 ohms \pm 0.1 ohm
Voltage across dummy load	3.4 V min, 4.5 V max

7881-ANSI-1002-2

25-Watt, 36-Inch T12, Rapid-Start Fluorescent Lamp

Lamp Description

Lamp abbreviation	25W/36T12/RS
Nominal wattage	25 watts
Nominal overall length	36 in (900mm)
Bulb designation	T12 (T38)
Base	G13 Medium bipin
Circuit application	Rapid start

Dimensional Characteristics (definitions of Part II apply)

	<u>Inches</u>		<u>Millimeters</u>	
	<u>Min</u>	<u>Max</u>	<u>Min</u>	<u>Max</u>
A (Base face to base face)	-	35.22	-	894.6
B (Base face to end of opposite base pin)	35.40	35.50	899.2	901.7
C (End of base pin to end of opposite base pin)	35.67	35.78	906.0	908.8
D (Bulb outside diameter)	1.41	1.59	35.8	40.4

Electrical Characteristics

Lamp Operating Characteristics (conditions of clause 11 apply)

Wattage	
Arc wattage (W)	24.5
Approximate cathode wattage (with 3.6 V on each cathode) (W)	2.0
Total wattage (W)	26.5
Voltage (V)	62
Current (A)	0.455

Reference Ballast Characteristics

Rated input voltage (V)	180
Reference current (A)	0.430
Impedance (ohms)	335

Cathode Characteristics

Type	Low resistance
Resistance (at 3.6 V)	
Objective (ohms)	9.6
Minimum (ohms)	7.0

7881-ANSI-1003-1

© 2014 National Electrical Manufacturers Association

Information for Ballast Design (conditions of clause 12 apply)

Lamp Starting Requirements

	<u>Single lamp</u>	<u>Ballasts for two lamps</u>
Rapid start		
Voltage between lamp terminals (Note 1)		
at 60°F (15°C) and above, (Vrms) min	175	215
at 60°F (15°C) and above, (Vrms) max	210	290
at 60°F (15°C) and above, (Vpeak) min	280	300
Waveshape of starting voltage crest factor, max	2.0	2.0
Lamp current crest factor, max	1.9	1.9
Starting capacitor size		
min (µF) (at 60 Hz)		0.04
max (µF) (at 60 Hz)		0.06

NOTE 1—These values are for lead circuits only.

Cathode Heat Requirements

Rapid start

Voltage	3.6 V nominal
Limits during operation	2.5 V min, 4.0 V max
Dummy load resistor	9.6 ohms ± 0.1 ohm
Voltage across dummy load	3.4 V min, 4.5 V max

NOTE 1—Single lamp ballasts designed to operate the 30W/36T12/RS lamp may or may not start the 25W/36T12/RS lamp.

7881-ANSI-1003-1

30-Watt, 36-Inch T12, Rapid-Start Fluorescent Lamp

This standard data sheet is compatible with IEC 60081.

Lamp description

Lamp abbreviation	30W/36T12/RS
Nominal wattage	30 watts
Nominal overall length	36 in (900mm)
Bulb designation	T12 (T38)
Base	G13, Medium bipin
Circuit application	Rapid start

Dimensional characteristics (definitions of Part II apply)

	Inches		Millimeters	
	Min	Max	Min	Max
A (Base face to base face)	-	35.22	-	894.6
B (Base face to end of opposite base pin)	35.40	35.50	899.2	901.7
C (End of base pin to end of opposite pin end)	35.67	35.78	906.0	908.8
D (Bulb, outside diameter)	1.41	1.59	35.8	40.4

Electrical characteristics

Lamp operating characteristics (conditions of clause 11 apply)

Wattage	
Arc wattage (W)	30.5
Approximate cathode wattage (with 3.6 V on each cathode) (W)	2.0
Total wattage (W)	32.5
Voltage (V)	77
Current (A)	0.430

Reference ballast characteristics

Rated input voltage (V)	180
Reference current (A)	0.430
Impedance (ohms)	335

Cathode characteristics

Type	Low resistance
Resistance (at 3.6 V)	
Objective (ohms)	9.6
Minimum (ohms)	7.0

7881-ANSI-1004-1

© 2014 National Electrical Manufacturers Association

Information for ballast design (conditions of clause 12 apply)

Lamp starting requirements

	<u>Single lamp</u>	<u>Ballasts for two lamps</u>	<u>Ballasts for three lamps</u>
Rapid start			
Voltage between lamp terminals (Note 1)			
at 50°F (10°C) and above, (Vrms) min	150	215	305
at 50°F (10°C) and above, (Vrms) max	205	290	410
at 0°F (-17.8°C) and above, (Vrms) min	180	245	335
Voltage lamp terminal to starting aid (Note 2)			
at 50°F (10°C) and above, (Vpeak) min	280	280	280
at 0°F (-17.8°C) and above, (Vpeak) min	500	500	500
Waveshape of starting voltage crest factor, max	2.0	2.0	2.0
Starting capacitor size			
min (µF) (at 60 Hz)		0.04	0.04
max (µF) (at 60 Hz)		0.06	0.06

NOTES—

- 1 These values are for lead circuits only. For lag circuits, add 3%.
- 2 These values are for crest factors of 1.55 to 2.0. Add 10% for crest factors less than 1.55.

Cathode heat requirements

Rapid start

Voltage	3.6 V nominal
Limits during operation	2.5 V min, 4.0 V max
Dummy load resistor	9.6 ohms ± 0.1 ohm
Voltage across dummy load	3.4 V min, 4.5 V max

7881-ANSI-1004-1

© 2014 National Electrical Manufacturers Association

32-Watt, 48-Inch T8 Fluorescent Lamp

Lamp Description

Lamp abbreviation	32W/48T8
Nominal wattage	32 watts
HF reference wattage	29 watts
Nominal overall length	48 in (1200mm)
Bulb designation	T8 (T25)
Base	G13, Medium bipin
Circuit application	Instant start, Programmed start, Rapid start

NOTE—The “nominal wattage” of 32W for this lamp reflects common commercial nomenclature. It represents the measured wattage on a 60 Hz reference ballast for 32W/48T8/RS fluorescent lamps. The high frequency (HF) reference wattage of 29W above reflects the measured wattage when operated on the HF reference ballast.

Dimensional characteristics (definitions of Part II apply)

	<u>Inches</u>		<u>Millimeters</u>	
	<u>Min</u>	<u>Max</u>	<u>Min</u>	<u>Max</u>
A (Base face to base face)	-	47.22	-	1199.4
B (Base face to end of opposite base pin)	47.40	47.50	1204.0	1206.5
C (End of base pin to end of opposite pin end)	47.67	47.78	1210.8	1213.6
D (Bulb, outside diameter)	0.94	1.10	23.9	27.9

Cathode characteristics (for heated-cathode starting methods)

Type	Low resistance
Resistance at 3.6 V	12.0 ± 2.0 ohms
R _h /R _c ratio at 3.6 V	4.75 ± 0.50

7881-ANSI-1005-3

© 2014 National Electrical Manufacturers Association

Electrical Characteristics (with a 25 kHz reference ballast)

Typical lamp electrical characteristics without coil heat will be as follows when the lamp is operated at 25 kHz with a resistive ballast. This represents a reference ballast circuit for HF operation. The following characteristics set the “rated wattage” for this lamp type. The HF reference ballast is specified to provide approximately the same lamp light output as when it is operated on a 60 Hz measurement ballast for 32W/48T8/RS fluorescent lamps with cathode heat.

Typical lamp operating characteristics (conditions of clause 11 apply)

Wattage (W)	29.2
Voltage (V)	137

Reference ballast characteristics

Typical input voltage (V)	467
Current (A)	0.217
Impedance (ohms)	1500
Frequency (kHz)	25

NOTE—The reference ballast characteristics are normative, and lamp current should be set to the indicated value during photometric and electrical measurements per the ANSLG C82.2, C82.3 and C78.375 standards. No cathode heat is applied for the HF reference measurements. The lamp operating characteristics are typical of average lamp performance on the reference ballast.

www.LisunGroup.com

7881-ANSI-1005-3

© 2014 National Electrical Manufacturers Association

**32-Watt, 48-Inch T8
Fluorescent Lamp
Page 3 of 5**

Information for HF ballast design (conditions of clause 12 apply)

Lamp current limits

Minimum design lamp current without cathode heat, I_{rms} (A)	0.155
Maximum design lamp current, I_{rms} (A)	0.320
Maximum lamp current crest factor	1.7

NOTE—Ballasts designed for lamps without cathode heating shall have a design minimum lamp current around 0.155 A. Variation around this design value due to potential tolerances related to components and manufacturing is expected. However, the lamp current shall not be less than 0.140 A under any condition without cathode heating. Further, the lamp current shall not exceed 0.335 A under any operating condition.

Instant start requirements

For lamp use on HF instant-start electronic ballasts. The requirements shall be met at any primary voltage between 90% and 110% of ballast's rated input voltage.

Lamp starting requirements

Open circuit voltage (min), V_{rms} , $T_{amb} \geq 50^\circ F$	465
Open circuit voltage (min), V_{rms} , $-20^\circ F \leq T_{amb} < 50^\circ F$	600
Maximum starting time (ms)	100

Programmed start requirements

For lamp use with HF programmed-start ballasts.

Lamp starting requirements

Preheating time	$0.4 \leq t \leq 1.5$ s
R_h/R_c limits defined by	$4.25 \leq R_h/R_c \leq 6.0$
Open circuit voltage (min), V_{rms} , $T_{amb} \geq 50^\circ F$	Under consideration

During preheating

Cathode heating voltage (max), V_{rms}	10
Voltage crest factor (max)	1.7
Lamp glow current (max), I_{rms} (A)	0.010

7881-ANSI-1005-3

© 2014 National Electrical Manufacturers Association

Rapid start requirements

For lamp use with HF rapid-start ballasts. The following limits are to be observed during the starting period. The requirements of C82.11 section 5.2.3 apply.

Cathode heat requirements

Voltage maximum during operation, V_{rms} 5.3 V

Information for dimming ballast design (Effective January 1, 2015)

For operation at reduced lamp current, the cathode requires supplemental ohmic heating by means of circulating current in the cathode. The following are specifications for the voltage drop, EV , across each cathode in a system of one or more lamps for a range of lamp current, I_D , in dimmed operation.

Maximum heating voltage (V):	$EV_{max} = 5.3$	
Minimum heating voltage (V):	$EV_{min} = 4.0$	for $0.020 \leq I_D < 0.050$ (A)
	$EV_{min} = 5.0 - 20 * I_D$	for $0.050 \leq I_D < 0.100$ (A)
	$EV_{min} = 8.45 - 54.5 * I_D$	for $0.100 \leq I_D < 0.155$ (A)
	$EV_{min} = 0$	for $0.155 \leq I_D$ (A)

7881-ANSI-1005-3

© 2014 National Electrical Manufacturers Association

**32-Watt, 48-Inch T8
Fluorescent Lamp
Page 5 of 5**

Information for 60 Hz ballast operation

The following information pertains to the former 32W/48T8/RS lamp specification. It is preserved here to allow a smooth transition from operation on 60 Hz ballasts to HF electronic ballasts. Whenever practical, the HF specifications should be used.

Rapid start requirements

	Single lamp	Ballasts for two lamps in series	
		Option A	Option B
Rapid start			
Voltage between lamp terminals (Note 1) at 50°F (10°C) and above, (V_{rms}) min	200	300	315
Voltage lamp terminal to starting aid (Note 2) at 60°F (15.6°C) and above, (V_{peak}) min	260	260	260
at 50°F (10°C) and above, (V_{peak}) min	290	290	290
Waveshape of starting voltage crest factor, max	2.0	2.0	2.0
Starting capacitor size			
min (μ F) (at 60 Hz)		0.08	0.04
max (μ F) (at 60 Hz)		0.12	0.06

NOTES—

- 1 These values are for lead circuits only. For lag circuits, the values are under consideration.
- 2 These values are for crest factors of 1.55 to 2.0. Add 20% for crest factors less than 1.55.

Cathode heat requirements – Rapid start

Voltage	3.6 V nominal
Limits during operation	2.5 V min, 4.4 V max
Dummy load resistor	11.0 ohms \pm 0.1 ohm
Voltage across dummy load	3.4 V min, 4.5 V max

7881-ANSI-1005-3

© 2014 National Electrical Manufacturers Association

34-Watt, 48-Inch T12, Rapid-Start Fluorescent Lamp

Lamp description

Lamp abbreviation	34W/48T12/RS
Nominal wattage	34 watts
Nominal overall length	48 in (1200mm)
Bulb designation	T12 (T38)
Base	G13, Medium bipin
Circuit application	Rapid start

Dimensional characteristics (definitions of Part II apply)

	Inches		Millimeters	
	Min	Max	Min	Max
A (Base face to base face)	-	47.22	-	1199.4
B (Base face to end of opposite base pin)	47.40	47.50	1204.0	1206.5
C (End of base pin to end of opposite pin end)	47.67	47.78	1210.8	1213.6
D (Bulb, outside diameter)	1.41	1.59	35.8	40.4

Electrical characteristics

Lamp operating characteristics (conditions of clause 11 apply)

Wattage	
Arc wattage (W)	32.0
Approximate cathode wattage (with 3.6 V on each cathode) (W)	2.0
Total wattage (W)	34.0
Voltage (V)	79
Current (A)	0.460

Reference ballast characteristics

Rated input voltage (V)	236
Reference current (A)	0.430
Impedance (ohms)	439

Cathode characteristics

Type	Low resistance
Resistance (at 3.6V)	
Objective (ohms)	9.6
Minimum (ohms)	7.0

7881-ANSI-1006-1

© 2014 National Electrical Manufacturers Association

**34-Watt, 48-Inch T12,
Rapid-Start Fluorescent Lamp
Page 2 of 2**

Information for ballast design (conditions of clause 12 apply)

Lamp starting requirements

	Single <u>lamp</u>	Ballasts for <u>two lamps</u>
Rapid start		
Voltage between lamp terminals (Note 1)		
at 60°F (15.5°C) and above, (Vrms) min	200	256
at 60°F (15.5°C) and above, (Vrms) max	260	330
at 60°F (15.5°C) and above, (Vpeak) min peak	315	380
Waveshape of starting voltage crest factor, max	2.0	2.0
Lamp current crest factor, maximum	1.9	1.9
Starting capacitor size		
min (μF) (at 60 Hz)		0.04
max (μF) (at 60 Hz)		0.06

NOTE 1—These values are for lead circuits only. For lag circuits, the values are under consideration.

Cathode heat requirements

Rapid start

Voltage	3.6 V nominal
Limits during operation	2.5 V min, 4.0 V max
Dummy load resistor	9.6 ohms ± 0.1 ohm
Voltage across dummy load	3.4 V min, 4.5 V max

7881-ANSI-1006-1

© 2014 National Electrical Manufacturers Association

40-Watt, 60-Inch T8 Fluorescent Lamp

Lamp Description

Lamp abbreviation	40W/60T8
Nominal wattage	40 watts
HF reference wattage	36 watts
Nominal overall length	60 in (1500mm)
Bulb designation	T8 (T25)
Base	G13, Medium bipin
Circuit application	Instant start, Programmed start, Rapid start

NOTE—The “nominal wattage” of 40W for this lamp reflects common commercial nomenclature. It represents the measured wattage on a 60 Hz reference ballast for 40W/60T8/RS fluorescent lamps. The high frequency (HF) reference wattage of 36W above reflects the measured wattage when operated on the HF reference ballast.

Dimensional characteristics (definitions of Part II apply)

	<u>Inches</u>		<u>Millimeters</u>	
	<u>Min</u>	<u>Max</u>	<u>Min</u>	<u>Max</u>
A (Base face to base face)	-	59.05	-	1499.9
B (Base face to end of opposite base pin)	59.24	59.33	1504.7	1507.0
C (End of base pin to end of opposite pin end)	59.50	59.61	1511.3	1514.1
D (Bulb, outside diameter)	0.94	1.10	23.9	27.9

Cathode characteristics (for heated-cathode starting methods)

Type	Low resistance
Resistance at 3.6 V	12.0 ± 2.0 ohms
R_h/R_c ratio at 3.6 V	4.75 ± 0.50

7881-ANSI-1007-2

© 2014 National Electrical Manufacturers Association

**40-Watt, 60-Inch T8
Fluorescent Lamp
Page 2 of 5**

Electrical Characteristics (with a 25 kHz reference ballast)

Typical lamp electrical characteristics without coil heat will be as follows when the lamp is operated at 25 kHz with a resistive ballast. This represents a reference ballast circuit for high-frequency operation. The following characteristics set the “rated wattage” for this lamp type. The HF reference ballast is specified to provide approximately the same lamp light output as when it is operated on a 60 Hz measurement ballast for 40W/60T8/RS fluorescent lamps with cathode heat.

Typical lamp operating characteristics (conditions of clause 11 apply)

Wattage (W)	36.4
Voltage (V)	171

Reference ballast characteristics

Typical input voltage (V)	489
Current (A)	0.215
Impedance (ohms)	1500
Frequency (kHz)	25

NOTE—The reference ballast characteristics are normative, and lamp current should be set to the indicated value during photometric and electrical measurements per the ANSLG C82.2, C82.3 and C78.375 standards. No cathode heat is applied for the HF reference measurements. The lamp operating characteristics are typical of average lamp performance on the reference ballast.

7881-ANSI-1007-2

© 2014 National Electrical Manufacturers Association

Information for HF ballast design (conditions of clause 12 apply)

Lamp current limits

Minimum design lamp current without cathode heat, I_{rms} (A)	0.155
Maximum design lamp current, I_{rms} (A)	0.320
Maximum lamp current crest factor	1.7

NOTE—Ballasts designed for lamps without cathode heating shall have a design minimum lamp current around 0.155 A. Variation around this design value due to potential tolerances related to components and manufacturing is expected. However, the lamp current shall not be less than 0.140 A under any condition without cathode heating. Further, the lamp current shall not exceed 0.335 A under any operating condition.

Instant start requirements

For lamp use on HF instant-start electronic ballasts. The requirements shall be met at any primary voltage between 90% and 110% of ballast's rated input voltage.

Lamp starting requirements

Open circuit voltage (min), V_{rms} , $T_{amb} \geq 50^\circ F$	500
Open circuit voltage (min), V_{rms} , $-20^\circ F \leq T_{amb} < 50^\circ F$	660
Maximum starting time (ms)	100

Programmed start requirements

For lamp use with HF programmed-start ballasts.

Lamp starting requirements

Preheating time	$0.4 \leq t \leq 1.5$ s
R_h/R_c limits defined by	$4.25 \leq R_h/R_c \leq 6.0$
Open circuit voltage (min), V_{rms} , $T_{amb} \geq 50^\circ F$	Under consideration

During preheating

Cathode heating voltage (max), V_{rms}	10
Voltage crest factor (max)	1.7
Lamp glow current (max), I_{rms} (A)	0.010

7881-ANSI-1007-2

© 2014 National Electrical Manufacturers Association

**40-Watt, 60-Inch T8
Fluorescent Lamp
Page 4 of 5**

Rapid start requirements

For lamp use with HF rapid-start ballasts. The following limits are to be observed during the starting period. The requirements of C82.11 section 5.2.3 apply.

Cathode heat requirements

Voltage maximum during operation, V_{rms} 5.3 V

Information for dimming ballast design (Effective January 1, 2015)

For operation at reduced lamp current, the cathode requires supplemental ohmic heating by means of circulating current in the cathode. The following are specifications for the voltage drop, EV , across each cathode in a system of one or more lamps for a range of lamp current, I_D , in dimmed operation.

Maximum heating voltage (V):	$EV_{max} = 5.3$	
Minimum heating voltage (V):	$EV_{min} = 4.0$	for $0.020 \leq I_D < 0.050$ (A)
	$EV_{min} = 5.0 - 20 \cdot I_D$	for $0.050 \leq I_D < 0.100$ (A)
	$EV_{min} = 8.45 - 54.5 \cdot I_D$	for $0.100 \leq I_D < 0.155$ (A)
	$EV_{min} = 0$	for $0.155 \leq I_D$ (A)

7881-ANSI-1007-2

© 2014 National Electrical Manufacturers Association

Information for 60 Hz ballast operation

The following information pertains to the former 40W/60T8/RS lamp specification. It is preserved here to allow a smooth transition from operation on 60 Hz ballasts to HF electronic ballasts. Whenever practical, the HF specifications should be used.

Rapid start requirements

	<u>Single lamp</u>	<u>Ballasts for two lamps</u>
Rapid start		
Voltage between lamp terminals (Note 1)		
at 50°F (10°C) and above, (V_{rms}) min	250	385
at 50°F (10°C) and above, (V_{rms}) max	340	520
Voltage lamp terminal to starting aid (Note 2)		
at 50°F (10°C) and above, (V_{peak}) min	325	325
Waveshape of starting voltage crest factor, max	2.0	2.0
Starting capacitor size		
min (μ F) (at 60 Hz)		0.04
max (μ F) (at 60 Hz)		0.06

NOTES—

- 1 These values are for lead circuits only. For lag circuits, the values are under consideration.
- 2 These values are for crest factors of 1.55 to 2.0. Add 20% for crest factors less than 1.55.

Cathode heat requirements – Rapid start

Voltage	3.6 V nominal
Limits during operation	2.5 V min, 4.4 V max
Dummy load resistor	11.0 ohms \pm 0.1 ohm
Voltage across dummy load	3.4 V min, 4.5 V max

7881-ANSI-1007-2

© 2014 National Electrical Manufacturers Association

40-Watt, 48-Inch T10, Rapid-Start Fluorescent Lamp

This standard data sheet is closely comparable with IEC Publication 60081.

Lamp description

Lamp abbreviation	40W/48T10/RS
Nominal wattage	40 watts
Nominal overall length	48 in (1200mm)
Bulb designation	T10 (T32)
Base	G13, Medium bipin
Circuit application	Rapid start

Dimensional characteristics (definitions of Part II apply)

	Inches		Millimeters	
	Min	Max	Min	Max
A (Base face to base face)	-	47.22	-	1199.4
B (Base face to end of opposite base pin)	47.40	47.50	1204.0	1206.5
C (End of base pin to end of opposite pin end)	47.67	47.78	1210.8	1213.6
D (Bulb, outside diameter)	1.16	1.34	29.5	34.0

Electrical characteristics

Lamp operating characteristics (conditions of clause 11 apply)

Wattage	
Arc wattage (W)	40.0
Approximate cathode wattage (with 3.6 V on each cathode) (W)	2.0
Total wattage (W)	42.0
Voltage (V)	104
Current (A)	0.420

Reference ballast characteristics

Rated input voltage (V)	236
Reference current (A)	0.430
Impedance (ohms)	439

Cathode characteristics

Type	Low resistance
Resistance (at 3.6 V)	
Objective (ohms)	9.6
Minimum (ohms)	7.0

7881-ANSI-1008-1

© 2014 National Electrical Manufacturers Association

Information for ballast design (conditions of clause 12 apply)

Lamp starting requirements

	<u>Single Lamp</u>	<u>Ballasts for two lamps</u>	<u>Ballasts for three lamps</u>
Rapid start			
Voltage between lamp terminals (Note 1)			
at 50°F (10°C) and above, (V _{rms}) min	200	256	395
at 0°F (-17.8°C) and above, (V _{rms}) max	260	330	525
Voltage lamp terminal to starting aid (Note 2)			
at 50°F (10°C) and above, (V _{peak}) min	240	240	280
Waveshape of starting voltage crest factor, max	2.0	2.0	2.0
Starting capacitor size			
min (μF) (at 60 Hz)		0.04	0.04
max (μF) (at 60 Hz)		0.06	0.06

NOTES—

1 These values are for lead circuits only. For lag circuits, add 3%.

2 These values are for crest factors of 1.55 to 2.0. Add 10% for crest factors less than 1.55.

Cathode heat requirements

Rapid start

Voltage	3.6 V nominal
Limits during operation	2.5 V min, 4.0 V max
Dummy load resistor	9.6 ohms ± 0.1 ohm
Voltage across dummy load	3.4 V min, 4.5 V max

7881-ANSI-1008-1

© 2014 National Electrical Manufacturers Association

40-Watt, T12, 1160-Millimeter, Rapid-Start Fluorescent Lamp

Lamp description

Lamp abbreviation	40W/1160mmT12/RS
Nominal wattage	40 watts
Nominal overall length	1160mm
Bulb designation	T12 (T38)
Base	G13, Medium bipin
Circuit application	Rapid start

Dimensional characteristics (definitions of Part II apply)

	Inches		Millimeters	
	Min	Max	Min	Max
A (Base face to base face)	-	45.67	-	1160.0
B (Base face to end of opposite base pin)	45.85	45.95	1164.6	1167.1
C (End of base pin to end of opposite pin end)	-	46.23	-	1174.2
D (Bulb, outside diameter)	1.41	1.59	35.8	40.4

Electrical characteristics

Lamp operating characteristics (conditions of clause 11 apply)

Wattage	
Arc wattage (W)	38.0
Approximate cathode wattage (with 3.6 V on each cathode) (W)	2.0
Total wattage (W)	40.0
Voltage (V)	98
Current (A)	0.432

Reference ballast characteristics

Rated input voltage (V)	236
Reference current (A)	0.430
Impedance (ohms)	439

Cathode characteristics

Type	Low resistance
Resistance (at 3.6 V)	
Objective (ohms)	9.6
Minimum (ohms)	7.0

7881-ANSI-1009-1

© 2014 National Electrical Manufacturers Association

Information for ballast design (conditions of clause 12 apply)

Lamp starting requirements

	<u>Single lamp</u>	<u>Ballasts for two lamps</u>	<u>Ballasts for three lamps</u>
Rapid start			
Voltage between lamp terminals (Note 1)			
at 50°F (10°C) and above, (V _{rms}) min	200	256	395
at 50°F (10°C) and above, (V _{rms}) max	260	330	525
Voltage lamp terminal to starting aid (Note 2)			
at 50°F (10°C) and above, (V _{peak}) min	240	240	280
Waveshape of starting voltage crest factor, max	2.0	2.0	2.0
Starting capacitor size			
min (μF) (at 60 Hz)		0.04	0.04
max (μF) (at 60 Hz)		0.06	0.06

NOTES—

- 1 These values are for lead circuits only. For lag circuits, add 3%.
- 2 These values are for crest factors of 1.55 to 2.0. Add 10% for crest factors less than 1.55.

Cathode heat requirements

Rapid start

Voltage	3.6 V nominal
Limits during operation	2.5 V min, 4.0 V max
Dummy load resistor	9.6 ohms ± 0.1 ohm
Voltage across dummy load	3.4 V min, 4.5 V max

7881-ANSI-1009-1

© 2014 National Electrical Manufacturers Association

40-Watt, 48-Inch T12, Rapid-Start Fluorescent Lamp

This standard data sheet is compatible with IEC 60081.

Lamp description

Lamp abbreviation	40W/48T12/RS
Nominal wattage	40 watts
Nominal overall length	48 in (1200mm)
Bulb Designation	T12 (T38)
Base	G13, Medium bipin
Circuit application	Rapid start, Preheat (switch)—start

Dimensional characteristics (definitions of Part II apply)

	Inches		Millimeters	
	Min	Max	Min	Max
A (Base face to base face)	-	47.22	-	1199.4
B (Base face to end of opposite base pin)	47.40	47.50	1204.0	1206.5
C (End of base pin to end of opposite pin end)	47.67	47.78	1210.8	1213.6
D (Bulb, outside diameter)	1.41	1.59	35.8	40.4

Electrical characteristics

Lamp operating characteristics (conditions of clause 11 apply)

Wattage	
Arc wattage (W)	39.0
Approximate cathode wattage (with 3.6 V on each cathode) (W)	2.0
Total wattage (W)	41.0
Voltage (V)	101
Current (A)	0.430

Reference ballast characteristics

Rated input voltage (V)	236
Reference current (A)	0.430
Impedance (ohms)	439

Cathode characteristics

Type	Low resistance
Resistance (at 3.6 V)	
Objective (ohms)	9.6
Minimum (ohms)	7.0

7881-ANSI-1010-1

© 2014 National Electrical Manufacturers Association

Information for ballast design (conditions of clause 12 apply)

Lamp starting requirements

	<u>Single lamp</u>	<u>Ballasts for two lamps</u>	<u>Ballasts for three lamps</u>
Rapid start			
Voltage between lamp terminals (Note 1)			
at 50°F (10°C) and above, (Vrms) min	200	256	395
at 50°F (10°C) and above, (Vrms) max	260	330	525
Voltage lamp terminal to starting aid (Note 2)			
at 50°F (10°C) and above, (Vpeak) min	240	240	280
Waveshape of starting voltage crest factor, max	2.0	2.0	2.0
Starting capacitor size			
min (µF) (at 60 Hz)		0.04	0.04
max (µF) (at 60 Hz)		0.06	0.06

Preheat (switch) start

Voltage between lamp terminals	
at 50°F (10°C) and above, (Vrms) min	176
at 50°F (10°C) and above, (Vrms) max	230
at 50°F (10°C) and above, (Vpeak) max	375
Voltage lamp terminal to ground (Vrms) max (Note 3)	135

NOTES—

- 1 These values are for lead circuits only. For lag circuits, add 3%.
- 2 These values are for crest factors of 1.55 to 2.0. Add 10% for crest factors less than 1.55.
- 3 Applies unless other means are provided to avoid instant starting.

Cathode heat requirements

Rapid start

Voltage	3.6 V nominal
Limits during operation	2.5 V min, 4.0 V max
Dummy load resistor	9.6 ohms ± 0.1 ohm
Voltage across dummy load	3.4 V min, 4.5 V max

Preheat (switch)—start

Current during preheat, at rated primary voltage	0.55 A min, 0.75 A max
Preheat time at 0.65 A preheat current	1.0 sec. min

7881-ANSI-1010-1

© 2014 National Electrical Manufacturers Association

37-Watt, 24-Inch T12, 0.800-Ampere, Rapid-Start Fluorescent Lamp

Lamp description

Lamp abbreviation	37W/24T12/HO
Nominal wattage	37 watts
Nominal overall length	24 in (600mm)
Bulb designation	T12 (T38)
Base	R17d, Recessed double contact
Circuit application	Rapid start, 0.8 A

Dimensional characteristics (definitions of Part II apply)

	<u>Inches</u>		<u>Millimeters</u>	
	<u>Min</u>	<u>Max</u>	<u>Min</u>	<u>Max</u>
C (Ends of opposite base bosses)	21.72	21.91	551.7	556.5
D (Bulb, outside diameter)	1.41	1.59	35.8	40.4

Electrical characteristics

Lamp operating characteristics (conditions of clause 11 apply)

Wattage	
Arc wattage (W)	30.0
Approximate cathode wattage (with 3.6 V on each cathode) (W)	7.0
Total wattage (W)	37.0
Voltage (V)	41
Current (A)	0.800

Reference ballast characteristics

Rated input voltage (V)	230
Reference current (A)	0.800
Impedance (ohms)	275

Cathode characteristics

Type	Low resistance
Resistance (at 3.6 V)	
Objective (ohms)	3.2
Minimum (ohms)	2.5

7881-ANSI-1011-1

© 2014 National Electrical Manufacturers Association

**37-Watt, 24-Inch T12, 0.800-Ampere,
Rapid-Start Fluorescent Lamp
Page 2 of 2**

Information for ballast design (conditions of clause 12 apply)

Lamp starting requirements

	<u>Single lamp</u>	<u>Ballasts for two lamps</u>	<u>Ballasts for three lamps</u>
Rapid start			
Voltage between lamp terminals (Note 1)			
at 50°F (10°C) and above, (Vrms) min	85	145	230
at 0°F (-17.8°C) and above, (Vrms) min	110	195	260
at -20°F (-28.9°C) and above, (Vrms) min	140	225	290
Voltage lamp terminal to starting aid (Note 2)			
at 50°F (10°C) and above, (Vpeak) min	325	325	325
at 0°F (-17.8°C) and above, (Vpeak) min	600	600	600
at -20°F (-28.9°C) and above, (Vpeak) min	700	700	700
Waveshape of starting voltage crest factor, max	2.0	2.0	2.0
Starting capacitor size			
min (μF) (at 60 Hz)		0.06	0.06
max (μF) (at 60 Hz)		0.12	0.12

NOTES—

- 1 These values are for lead circuits only. For lag circuits, add 6%.
- 2 These values are for crest factors of 1.55 to 2.0. Add 10% for crest factors less than 1.55.

Cathode heat requirements

Rapid start

Voltage	3.6 V nominal
Limits during operation	3.0 V min, 4.0 V max
Dummy load resistor	3.2 ohms ± 0.05 ohm
Voltage across dummy load	3.4 V min, 4.5 V max

7881-ANSI-1011-1

© 2014 National Electrical Manufacturers Association

50-Watt, 36-Inch T12, 0.800-Ampere, Rapid-Start Fluorescent Lamp

Lamp description

Lamp abbreviation	50W/36T12/HO
Nominal wattage	50 watts
Nominal overall length	36 in (900mm)
Bulb designation	T12 (T38)
Base	R17d, Recessed double contact
Circuit application	Rapid start, 0.8 A

Dimensional characteristics (definitions of Part II apply)

	<u>Inches</u>		<u>Millimeters</u>	
	<u>Min</u>	<u>Max</u>	<u>Min</u>	<u>Max</u>
C (Ends of opposite base bosses)	33.72	33.91	856.5	861.3
D (Bulb, outside diameter)	1.41	1.59	35.8	40.4

Electrical characteristics

Lamp operating characteristics (conditions of clause 11 apply)

Wattage	
Arc wattage (W)	43.0
Approximate cathode wattage (with 3.6 V on each cathode) (W)	7.0
Total wattage (W)	50.0
Voltage (V)	59.0
Current (A)	0.800

Reference ballast characteristics

Rated input voltage (V)	230
Reference current (A)	0.800
Impedance (ohms)	260

Cathode characteristics

Type	Low resistance
Resistance (at 3.6 V)	
Objective (ohms)	3.2
Minimum (ohms)	2.5

7881-ANSI-1012-1

© 2014 National Electrical Manufacturers Association

**50-Watt, 36-Inch T12, 0.800-Ampere,
Rapid-Start Fluorescent Lamp
Page 2 of 2**

Information for ballast design (conditions of clause 12 apply)

Lamp starting requirements

	<u>Single lamp</u>	<u>Ballasts for two lamps</u>	<u>Ballasts for three lamps</u>
Rapid start			
Voltage between lamp terminals (Note 1)			
at 50°F (10°C) and above, (Vrms) min	115	195	300
at 0°F (-17.8°C) and above, (Vrms) min	155	235	340
at -20°F (-28.9°C) and above, (Vrms) min	190	260	360
Voltage lamp terminal to starting aid (Note 2)			
at 50°F (10°C) and above, (Vpeak) min	325	325	325
at 0°F (-17.8°C) and above, (Vpeak) min	600	600	600
at -20°F (-28.9°C) and above, (Vpeak) min	700	700	700
Waveshape of starting voltage crest factor, max	2.0	2.0	2.0
Starting capacitor size			
min (μF) (at 60 Hz)		0.06	0.06
max (μF) (at 60 Hz)		0.12	0.12

NOTES—

1 These values are for lead circuits only. For lag circuits, add 6%.

2 These values are for crest factors of 1.55 to 2.0. Add 10% for crest factors less than 1.55.

Cathode heat requirements

Rapid start

Voltage	3.6 V nominal
Limits during operation	3.0 V min, 4.0 V max
Dummy load resistor	3.2 ohms ± 0.05 ohm
Voltage across dummy load	3.4 V min, 4.5 V max

7881-ANSI-1012-1

© 2014 National Electrical Manufacturers Association

63-Watt, 48-Inch T12, 0.800-Ampere and 1.0-Ampere, Rapid-Start Fluorescent Lamp

This standard data sheet is compatible with IEC 60081.

Lamp description

Lamp abbreviation	63W/48T12/HO
Nominal wattage	63 watts at 0.800 A, 71 watts at 1.0 A
Nominal overall length	48 in (1200mm)
Bulb designation	T12 (T38)
Base	R17d, Recessed double contact
Circuit application	Rapid start, 0.8 A and 1.0 A

Dimensional characteristics (definitions of Part II apply)

	<u>Inches</u>		<u>Millimeters</u>	
	<u>Min</u>	<u>Max</u>	<u>Min</u>	<u>Max</u>
C (Ends of opposite base bosses)	45.72	45.91	1161.3	1166.1
D (Bulb, outside diameter)	1.41	1.59	335.8	40.4

Electrical characteristics

Lamp operating characteristics (conditions of clause 11 apply)

Wattage	<u>At 0.800 A</u>	<u>At 1.000 A</u>
Arc wattage (W)	56.0	64.0
Approximate cathode wattage (with 3.6 V on each cathode) (W)	7.0	7.0
Total wattage (W)	63.0	71.0
Voltage (V)	78.0	71.0
Current (A)	0.800	1.000

Reference ballast characteristics

Rated input voltage (V)	230	230
Reference current (A)	0.800	1.000
Impedance (ohms)	244	200

Cathode characteristics

Type	Low resistance
Resistance (at 3.6 V)	
Objective (ohms)	3.2
Minimum (ohms)	2.5

7881-ANSI-1013-1

© 2014 National Electrical Manufacturers Association

**63-Watt, 48-Inch T12, 0.800-Ampere and 1.0-Ampere,
Rapid-Start Fluorescent Lamp
Page 2 of 2**

Information for ballast design (conditions of clause 12 apply)

Lamp starting requirements

	<u>Single lamp</u>	<u>Ballasts for two lamps</u>	<u>Ballasts for three lamps</u>
Rapid start			
Voltage between lamp terminals (Note 1)			
at 50°F (10°C) and above, (Vrms) min	155	256	385
at 0°F (-17.8°C) and above, (Vrms) min	203	290	405
at -20°F (-28.9°C) and above, (Vrms) min	240	310	405
Voltage lamp terminal to starting aid (Note 2)			
at 50°F (10°C) and above, (Vpeak) min	325	325	325
at 0°F (-17.8°C) and above, (Vpeak) min	600	600	600
at -20°F (-28.9°C) and above, (Vpeak) min	700	700	700
Waveshape of starting voltage crest factor, max	2.0	2.0	2.0
Starting capacitor size			
min (µF) (at 60 Hz)		0.06	0.06
max (µF) (at 60 Hz)		0.12	0.12

NOTES—

- 1 These values are for lead circuits only. For lag circuits, add 6%.
- 2 These values are for crest factors of 1.55 to 2.0. Add 10% for crest factors less than 1.55.

Cathode heat requirements

Rapid start

Voltage, during operation	3.6 V nominal
Limits	3.0 V min, 4.0 V max
Dummy load resistor	3.2 ohms ± 0.05 ohm
Voltage across dummy load	3.4 V min, 4.5 V max

7881-ANSI-1013-1

© 2014 National Electrical Manufacturers Association

75-Watt, 60-Inch T12, 0.800-Ampere, Rapid-Start Fluorescent Lamp

Lamp description

Lamp abbreviation	75W/60T12/HO
Nominal wattage	75 watts
Nominal overall length	60 in (1500mm)
Bulb designation	T12 (T38)
Base	R17d, Recessed double contact
Circuit application	Rapid start, 0.8 A

Dimensional characteristics (definitions of Part II apply)

	<u>Inches</u>		<u>Millimeters</u>	
	<u>Min</u>	<u>Max</u>	<u>Min</u>	<u>Max</u>
C (Ends of opposite base bosses)	57.72	57.91	1466.1	1470.0
D (Bulb, outside diameter)	1.41	1.59	35.8	40.4

Electrical characteristics

Lamp operating characteristics (conditions of clause 11 apply)

Wattage	
Arc wattage (W)	68.5
Approximate cathode wattage (with 3.6 V on each cathode) (W)	7.0
Total wattage (W)	75.5
Voltage (V)	98
Current (A)	0.800

Reference ballast characteristics

Rated input voltage (V)	300
Reference current (A)	0.800
Impedance (ohms)	325

Cathode characteristics

Type	Low resistance
Resistance (at 3.6 V)	
Objective (ohms)	3.2
Minimum (ohms)	2.5

7881-ANSI-1014-1

© 2014 National Electrical Manufacturers Association

**75-Watt, 60-Inch T12, 0.800-Ampere,
Rapid-Start Fluorescent Lamp
Page 2 of 2**

Information for ballast design (conditions of clause 12 apply)

Lamp starting requirements

	<u>Single Lamp</u>	<u>Ballasts for two lamps</u>	<u>Ballasts for three lamps</u>
Rapid start			
Voltage between lamp terminals (Note 1)			
at 50°F (10°C) and above, (Vrms) min	210	325	470
at 0°F (-17.8°C) and above, (Vrms) min	240	350	475
at -20°F (-28.9°C) and above, (Vrms) min	290	365	475
Voltage lamp terminal to starting aid (Note 2)			
at 50°F (10°C) and above, (Vpeak) min	325	325	325
at 0°F (-17.8°C) and above, (Vpeak) min	600	600	600
at -20°F (-28.9°C) and above, (Vpeak) min	700	700	700
Waveshape of starting voltage crest factor, max	2.0	2.0	2.0
Starting capacitor size			
min (μF) (at 60 Hz)		0.06	0.06
max (μF) (at 60 Hz)		0.12	0.12

NOTES—

- 1 These values are for lead circuits only. For lag circuits, add 6%.
- 2 These values are for crest factors of 1.55 to 2.0. Add 10% for crest factors less than 1.55.

Cathode heat requirements

Rapid start

Voltage	3.6 V nominal
Limits during operation	3.0 V min, 4.0 V max
Dummy load resistor	3.2 ohms ± 0.05 ohm
Voltage across dummy load	3.4 V min, 4.5 V max

7881-ANSI-1014-1

© 2014 National Electrical Manufacturers Association

87-Watt, 72-Inch T12, G20 Base, 0.800-Ampere and 1.0-Ampere, Rapid-Start Fluorescent Lamp

Lamp description

Lamp abbreviation	87W/72T12/H0
Nominal wattage	87 watts at 0.800 A, 101 watts at 1.0 A
Nominal overall length	72 in (1800mm)
Bulb designation	T12 (T38)
Base	G20, Mogul bipin
Circuit application	Rapid start, 0.8 A and 1.0 A

Dimensional characteristics (definitions of Part II apply)

	<u>Inches</u>		<u>Millimeters</u>	
	<u>Min</u>	<u>Max</u>	<u>Min</u>	<u>Max</u>
A (Base face to base face)	-	70.30	-	1785.6
B (Base face to end of opposite base pin)	70.72	70.93	1796.3	1801.6
C (End of base pin to end of opposite pin end)	-	71.56	-	1817.6
D (Bulb, outside diameter)	1.41	1.59	35.7	40.5

Electrical characteristics

Lamp operating characteristics (conditions of clause 11 apply)

Wattage	<u>At 0.800 A</u>	<u>At 1.000 A</u>
Arc wattage (W)	80.0	94.0
Approximate cathode wattage (with 3.6 V on each cathode) (W)	7.0	7.0
Total wattage (W)	87.0	101.0
Voltage (V)	117.0	108.0
Current (A)	0.780	0.985

Reference ballast characteristics

Rated input voltage (V)	300	300
Reference current (A)	0.800	1.000
Impedance (ohms)	315	257

Cathode characteristics

Type	Low resistance
Resistance (at 3.6 V)	
Objective (ohms)	3.2
Minimum (ohms)	2.5

7881-ANSI-1015-1

© 2014 National Electrical Manufacturers Association

**87-Watt, 72-Inch T12, G20 Base,
0.800-Ampere and 1.0-Ampere,
Rapid-Start Fluorescent Lamp**
Page 2 of 2

Information for ballast design (conditions of clause 12 apply)

Lamp starting requirements

	<u>Single lamp</u>	<u>Ballasts for two lamps</u>	<u>Ballasts for three lamps</u>
Rapid start			
Voltage between lamp terminals (Note 1)			
at 50°F (10°C) and above, (Vrms) min	260	395	550
at 0°F (-17.8°C) and above, (Vrms) min	283	410	550
at -20°F (-28.9°C) and above, (Vrms) min	340	420	550
Voltage lamp terminal to starting aid (Note 2)			
at 50°F (10°C) and above, (Vpeak) min	325	325	325
at 0°F (-17.8°C) and above, (Vpeak) min	600	600	600
at -20°F (-28.9°C) and above, (Vpeak) min	700	700	700
Waveshape of starting voltage crest factor, max	2.0	2.0	2.0
Starting capacitor size			
min (µF) (at 60 Hz)		0.06	0.06
max (µF) (at 60 Hz)		0.12	0.12

NOTES—

- 1 These values are for lead circuits only. For lag circuits, add 6%.
- 2 These values are for crest factors of 1.55 to 2.0. Add 10% for crest factors less than 1.55.

Cathode heat requirements

Rapid start

Voltage	3.6 V nominal
Limits during operation	3.0 V min, 4.0 V max
Dummy load resistor	3.2 ohms ± 0.05 ohm
Voltage across dummy load	3.4 V min, 4.5 V max

7881-ANSI-1015-1

© 2014 National Electrical Manufacturers Association

87-Watt, 72-Inch T12, R17d base, 0.800-Ampere and 1.0-Ampere, Rapid-Start Fluorescent Lamp

This standard data sheet is compatible with IEC 60081.

Lamp description

Lamp abbreviation	87W/72T12/HO
Nominal wattage	87 watts at 0.800 A, 101 watts at 1.0 A
Nominal overall length	72 in (1800mm)
Bulb designation	T12 (T38)
Base	R17d, Recessed double contact
Circuit application	Rapid start, 0.8 A and 1.0 A

Dimensional characteristics (definitions of Part II apply)

	<u>Inches</u>		<u>Millimeters</u>	
	<u>Min</u>	<u>Max</u>	<u>Min</u>	<u>Max</u>
C (Ends of opposite base bosses)	69.72	69.91	1770.9	1775.7
D (Bulb, outside diameter)	1.41	1.59	35.8	40.4

Electrical characteristics

Lamp operating characteristics (conditions of clause 11 apply)

	<u>At 0.800 A</u>	<u>At 1.000 A</u>
Wattage		
Arc wattage (W)	80.0	94.0
Approximate cathode wattage (with 3.6 V on each cathode) (W)	7.0	7.0
Total wattage (W)	87.0	101.0
Voltage (V)	117.0	108.0
Current (A)	0.780	0.985

Reference ballast characteristics

Rated input voltage (V)	300	300
Reference current (A)	0.800	1.000
Impedance (ohms)	315	257

Cathode characteristics

Type	Low resistance
Resistance (at 3.6 V)	
Objective (ohms)	3.2
Minimum (ohms)	2.5

7881-ANSI-1016-1

© 2014 National Electrical Manufacturers Association

**87-Watt, 72-Inch T12, R17d base,
0.800-Ampere and 1.0-Ampere,
Rapid-Start Fluorescent Lamp**
Page 2 of 2

Information for ballast design (conditions of clause 12 apply)

Lamp starting requirements

	<u>Single lamp</u>	<u>Ballasts for two lamps</u>	<u>Ballasts for three lamps</u>
Rapid start			
Voltage between lamp terminals (Note 1)			
at 50°F (10°C) and above, (Vrms) min	260	395	550
at 0°F (-17.8°C) and above, (Vrms) min	283	410	550
at -20°F (-28.9°C) and above, (Vrms) min	340	420	550
Voltage lamp terminal to starting aid (Note 2)			
at 50°F (10°C) and above, (Vpeak) min	325	325	325
at 0°F (-17.8°C) and above, (Vpeak) min	600	600	600
at -20°F (-28.9°C) and above, (Vpeak) min	700	700	700
Waveshape of starting voltage crest factor, max	2.0	2.0	2.0
Starting capacitor size			
min (μF) (at 60 Hz)		0.06	0.06
max (μF) (at 60 Hz)		0.12	0.12

NOTES—

- 1 These values are for lead circuits only. For lag circuits, add 6%.
- 2 These values are for crest factors of 1.55 to 2.0. Add 10% for crest factors less than 1.55.

Cathode heat requirements

Rapid start

Voltage	3.6 V nominal
Limits during operation	3.0 V min, 4.0 V max
Dummy load resistor	3.2 ohms ± 0.05 ohm
Voltage across dummy load	3.4 V min, 4.5 V max

7881-ANSI-1016-1

© 2014 National Electrical Manufacturers Association

95-Watt, 96-Inch T12, 0.800-Ampere, Rapid-Start Fluorescent Lamp

Lamp description

Lamp abbreviation	95W/96T12/HO
Nominal wattage	95 watts
Nominal overall length	96 in (2400mm)
Bulb designation	T12 (T38)
Base	R17d, Recessed double contact
Circuit application	Rapid start, 0.8 A

Dimensional characteristics (definitions of Part II apply)

	<u>Inches</u>		<u>Millimeters</u>	
	<u>Min</u>	<u>Max</u>	<u>Min</u>	<u>Max</u>
C (Ends of opposite base bosses)	93.72	93.91	2380.5	2385.3
D (Bulb, outside diameter)	1.41	1.59	35.8	40.4

Electrical characteristics

Lamp operating characteristics (conditions of clause 11 apply)

Wattage	
Arc wattage (W)	90.0
Approximate cathode wattage (with 3.6 V on each cathode) (W)	7.0
Total wattage (W)	97.0
Voltage (V)	126
Current (A)	0.830

Reference ballast characteristics

Rated input voltage (V)	400
Reference current (A)	0.800
Impedance (ohms)	415

Cathode characteristics

Type	Low resistance
Resistance (at 3.6 V)	
Objective (ohms)	3.2
Minimum (ohms)	2.5

7881-ANSI-1017-1

© 2014 National Electrical Manufacturers Association

Information for ballast design (conditions of clause 12 apply)

Lamp starting requirements

	<u>Ballasts for two lamps</u>	<u>Ballasts for three lamps</u>
Rapid start		
Voltage between lamp terminals (Note 1) at 60°F (15.5°C) and above, (V _{rms}) min	465	660
Voltage lamp terminal to starting aid (Note 2) at 60°F (15.5°C) and above, (V _{peak}) min	600	600
Waveshape of starting voltage crest factor, max	2.0	2.0
Lamp current crest factor, max	1.90	1.90
Starting capacitor size		
min (μF) (at 60 Hz)	0.06	0.06
max (μF) (at 60 Hz)	0.12	0.12

NOTES—

- 1 These values are for lead circuits only. For lag circuits, add 6%.
- 2 These values are for crest factors of 1.55 to 2.0. Add 10% for crest factors less than 1.55.

Cathode heat requirements

Rapid start

Voltage	3.6 V nominal
Limits during operation	3.0 V min, 4.0 V max
Dummy load resistor	3.2 ohms ± 0.05 ohm
Voltage across dummy load	3.4 V min, 4.5 V max

7881-ANSI-1017-1

© 2014 National Electrical Manufacturers Association

100-Watt, 84-Inch T12, 0.800-Ampere, Rapid-Start Fluorescent Lamp

Lamp description

Lamp abbreviation	100W/84T12/HO
Nominal wattage	100 watts
Nominal overall length	84 in (2100mm)
Bulb designation	T12 (T38)
Base	R17d, Recessed double contact
Circuit application	Rapid start, 0.8 A

Dimensional characteristics (definitions of Part II apply)

	Inches		Millimeters	
	<u>Min</u>	<u>Max</u>	<u>Min</u>	<u>Max</u>
C (Ends of opposite base bosses)	81.72	81.91	2075.7	2080.5
D (Bulb, outside diameter)	1.41	1.59	35.8	40.4

Electrical characteristics

Lamp operating characteristics (conditions of clause 11 apply)

Wattage	
Arc wattage (W)	93.0
Approximate cathode wattage (with 3.6 V on each cathode) (W)	7.0
Total wattage (W)	100.0
Voltage (V)	135
Current (A)	0.800

Reference ballast characteristics

Rated input voltage (V)	400
Reference current (A)	0.800
Impedance (ohms)	430

Cathode characteristics

Type	Low resistance
Resistance (at 3.6 V)	
Objective (ohms)	3.2
Minimum (ohms)	2.5

7881-ANSI-1018-1

© 2014 National Electrical Manufacturers Association

**100-Watt, 84-Inch T12, 0.800 Ampere,
Rapid-Start Fluorescent Lamp
Page 2 of 2**

Information for ballast design (conditions of clause 12 apply)

Lamp starting requirements

	<u>Single lamp</u>	<u>Ballasts for two lamps</u>	<u>Ballasts for three lamps</u>
Rapid start			
Voltage between lamp terminals (Note 1)			
at 50°F (10°C) and above, (Vrms) min	280	430	605
at 0°F (-17.8°C) and above, (Vrms) min	330	445	605
at -20°F (-28.9°C) and above, (Vrms) min	360	455	605
Voltage lamp terminal to starting aid (Note 2)			
at 50°F (10°C) and above, (Vpeak) min	325	325	325
at 0°F (-17.8°C) and above, (Vpeak) min	600	600	600
at -20°F (-28.9°C) and above, (Vpeak) min	700	700	700
Waveshape of starting voltage crest factor, max	2.0	2.0	2.0
Starting capacitor size			
min (µF) (at 60 Hz)		0.06	0.06
max (µF) (at 60 Hz)		0.12	0.12

NOTES—

- 1 These values are for lead circuits only. For lag circuits, add 6%.
- 2 These values are for crest factors of 1.55 to 2.0. Add 10% for crest factors less than 1.55.

Cathode heat requirements

Rapid start

Voltage	3.6 V nominal
Limits during operation	3.0 V min, 4.0 V max
Dummy load resistor	3.2 ohms ± 0.05 ohm
Voltage across dummy load	3.4 V min, 4.5 V max

7881-ANSI-1018-1

© 2014 National Electrical Manufacturers Association

113-Watt, 96-Inch T12, 0.800-Ampere and 1.0-Ampere, Rapid-Start Fluorescent Lamp

This standard data sheet is compatible with IEC 60081

Lamp description

Lamp abbreviation	113W/96T12/HO
Nominal wattage	113 Watts at 0.800 A 128 Watts at 1.00 A
Nominal overall length	96 in (2400mm)
Bulb designation	T12 (T38)
Base	R17d, Recessed double contact
Circuit application	Rapid start, 0.8 A and 1.0 A, for cold temperature installation

Dimensional characteristics (definitions of Part II apply)

	<u>Inches</u>		<u>Millimeters</u>	
	<u>Min</u>	<u>Max</u>	<u>Min</u>	<u>Max</u>
C (Ends of opposite base bosses)	93.72	93.91	2380.5	2385.3
D (Bulb, outside diameter)	1.41	1.59	35.8	40.4

Electrical characteristics

Lamp operating characteristics (conditions of clause 11 apply)

Wattage	<u>At 0.800 A</u>	<u>At 1.000 A</u>
Arc wattage (W)	106.0	121.0
Approximate cathode wattage (with 3.6 V on each cathode) (W)	7.0	7.0
Total wattage (W)	113.0	128.0
Voltage (V)	153	139
Current (A)	0.790	1.000

Reference ballast characteristics

Rated input voltage (V)	400	400
Reference current (A)	0.800	1.000
Impedance (ohms)	415	337

Cathode characteristics

Type	Low resistance
Resistance (at 3.6 V)	
Objective (ohms)	3.2
Minimum (ohms)	2.5

7881-ANSI-1019-1

© 2014 National Electrical Manufacturers Association

**113-Watt, 96-Inch T12,
0.800-Ampere and 1.0-Ampere,
Rapid-Start Fluorescent Lamp
Page 2 of 2**

Information for ballast design (conditions of clause 12 apply)

Lamp starting requirements

	<u>Single lamp</u>	<u>Ballasts for two lamps</u>	<u>Ballasts for three lamps</u>
Rapid start			
Voltage between lamp terminals (Note 1)			
at 50°F (10°C) and above, (Vrms) min	295	465	660
at 0°F (-17.8°C) and above, (Vrms) min	330	480	660
at -20°F (-28.9°C) and above, (Vrms) min	360	490	660
Voltage lamp terminal to starting aid (Note 2)			
at 50°F (10°C) and above, (Vpeak) min	325	325	325
at 0°F (-17.8°C) and above, (Vpeak) min	600	600	600
at -20°F (-28.9°C) and above, (Vpeak) min	700	700	700
Waveshape of starting voltage crest factor, max	2.0	2.0	2.0
Starting capacitor size			
min (µF) (at 60 Hz)		0.06	0.06
max (µF) (at 60 Hz)		0.12	0.12

NOTES—

- 1 These values are for lead circuits only. For lag circuits, add 6%.
- 2 These values are for crest factors of 1.55 to 2.0. Add 10% for crest factors less than 1.55.

Cathode heat requirements

Rapid start

Voltage	3.6 V nominal
Limits during operation	3.0 V min, 4.0 V max
Dummy load resistor	3.2 ohms + 0.05 ohm
Voltage across dummy load	3.4 V min, 4.5 V max

7881-ANSI-1019-1

© 2014 National Electrical Manufacturers Association

116-Watt, 48-Inch T12, 1.5-Ampere, Rapid-Start Fluorescent Lamp

Lamp description

Lamp abbreviation	116W/48T12/1.5 A
Nominal wattage	116 watts
Nominal overall length	48 in (1200mm)
Bulb designation	T12 (T38)
Base	R17d, Recessed double contact
Circuit application	Rapid start, 1.5 A

Dimensional characteristics (definitions of Part II apply)

	<u>Inches</u>		<u>Millimeters</u>	
	<u>Min</u>	<u>Max</u>	<u>Min</u>	<u>Max</u>
C (Ends of opposite base bosses)	45.72	45.91	1161.3	1166.1
D (Bulb, outside diameter)	1.41	1.59	35.8	40.4

Electrical characteristics

Lamp operating characteristics (conditions of clause 11 apply)

Wattage	
Arc wattage (W)	109.0
Approximate cathode wattage (with 3.6 V on each cathode) (W)	7.0
Total wattage (W)	116.0
Voltage (V)	84
Current (A)	1.500

Reference ballast characteristics

Rated input voltage (V)	300
Reference current (A)	1.500
Impedance (ohms)	179

Cathode characteristics

Type	Low resistance
Resistance (at 3.6 V)	
Objective (ohms)	3.2
Minimum (ohms)	2.0

7881-ANSI-1021-1

© 2014 National Electrical Manufacturers Association

**116-Watt, 48-Inch T12, 1.5-Ampere,
Rapid-Start Fluorescent Lamp
Page 2 of 2**

Information for ballast design (conditions of clause 12 apply)

Lamp starting requirements

	<u>Single lamp</u>	<u>Ballasts for two lamps</u>	<u>Ballasts for three lamps</u>
Rapid start			
Voltage between lamp terminals (Note 1)			
at 50°F (10°C) and above, (Vrms) min	160	250	350
at 0°F (-17.8°C) and above, (Vrms) min	205	265	350
at -20°F (-28.9°C) and above, (Vrms) min	240	300	385
Voltage lamp terminal to starting aid (Note 2)			
at 50°F (10°C) and above, (Vpeak) min	400	400	400
at 0°F (-17.8°C) and above, (Vpeak) min	575	575	575
at -20°F (-28.9°C) and above, (Vpeak) min	650	650	650
Waveshape of starting voltage crest factor, max	2.0	2.0	2.0
Starting capacitor size			
min (µF) (at 60 Hz)		0.06	0.06
max (µF) (at 60 Hz)		0.12	0.12

NOTES—

1 These values are for lead circuits only. For lag circuits, add 10%.

2 These values are for crest factors of 1.55 to 2.0. Add 10% for crest factors less than 1.55.

Cathode heat requirements

Rapid start

Voltage	3.6 V nominal
Limits during operation	3.3 V min, 4.3 V max
Dummy load resistor	3.2 ohms ± 0.05 ohm
Voltage across dummy load	3.4 V min, 4.5 V max

7881-ANSI-1021-1

© 2014 National Electrical Manufacturers Association

116-Watt, 48-Inch PG17, 1.5-Ampere, Rapid-Start Fluorescent Lamp

Lamp description

Lamp abbreviation	116W/48PG17/1.5 A
Nominal Wattage	116 watts
Nominal overall length	48 in (1200mm)
Bulb designation	TD17 (TD54)
Base	R17d, Recessed double contact
Circuit application	Rapid start, 1.5 A

Dimensional characteristics (definitions of Part II apply)

	<u>Inches</u>		<u>Millimeters</u>	
	<u>Min</u>	<u>Max</u>	<u>Min</u>	<u>Max</u>
C (Ends of opposite base bosses)	45.72	45.91	1161.3	1166.1
D (Bulb, outside diameter)	2.00	2.22	50.8	56.4

Electrical characteristics

Lamp operating characteristics (conditions of clause 11 apply)

Wattage	
Arc wattage (W)	109
Approximate cathode wattage (with 3.6 V on each cathode) (W)	7.0
Total wattage (W)	116.0
Voltage (V)	84
Current (A)	1.500

Reference ballast characteristics

Rated input voltage (V)	300
Reference current (A)	1.500
Impedance (ohms)	179

Cathode characteristics

Type	Low resistance
Resistance (at 3.6 V)	
Objective (ohms)	3.2
Minimum (ohms)	2.0

7881-ANSI-1022-1

© 2014 National Electrical Manufacturers Association

**116-Watt, 48-Inch PG17, 1.5-Ampere
Rapid-Start Fluorescent Lamp
Page 2 of 2**

Information for ballast design (conditions of clause 12 apply)

Lamp starting requirements

	<u>Single lamp</u>	<u>Ballasts for two lamps</u>	<u>Ballasts for three lamps</u>
Rapid start			
Voltage between lamp terminals (Note 1)			
at 50°F (10°C) and above, (Vrms) min	160	250	350
at 0°F (-17.8°C) and above, (Vrms) min	205	265	350
at -20°F (-28.9°C) and above, (Vrms) min	240	300	385
Voltage lamp terminal to starting aid (Note 2)			
at 50°F (10°C) and above, (Vpeak) min	400	400	400
at 0°F (-17.8°C) and above, (Vpeak) min	575	575	575
at -20°F (-28.9°C) and above, (Vpeak) min	650	650	650
Waveshape of starting voltage crest factor, max	2.0	2.0	2.0
Starting capacitor size			
min (µF) (at 60 Hz)		0.06	0.06
max (µF) (at 60 Hz)		0.12	0.12

NOTES—

1 These values are for lead circuits only. For lag circuits, add 10%.

2 These values are for crest factors of 1.55 to 2.0. Add 10% for crest factors less than 1.55.

Cathode heat requirements

Rapid start

Voltage	3.6 V nominal
Limits during operation	3.3 V min, 4.3 V max
Dummy load resistor	3.2 ohms ± 0.05 ohm
Voltage across dummy load	3.4 V min, 4.5 V max

7881-ANSI-1022-1

© 2014 National Electrical Manufacturers Association

168-Watt, 72-Inch T12, 1.5-Ampere, Rapid-Start Fluorescent Lamp

Lamp description

Lamp abbreviation	168W/72T12/1.5 A
Nominal wattage	168 watts
Nominal overall length	72 in (1800mm)
Bulb designation	T12 (T38)
Base	R17d, Recessed double contact
Circuit application	Rapid start, 1.5 A

Dimensional characteristics (definitions of Part II apply)

	<u>Inches</u>		<u>Millimeters</u>	
	<u>Min</u>	<u>Max</u>	<u>Min</u>	<u>Max</u>
C (Ends of opposite base bosses)	69.72	69.91	1770.9	1775.7
D (Bulb, outside diameter)	1.41	1.59	35.8	40.4

Electrical characteristics

Lamp operating characteristics (conditions of clause 11 apply)

Wattage	
Arc wattage (W)	161.0
Approximate cathode wattage (with 3.6 V on each cathode) (W)	7.0
Total wattage (W)	168.0
Voltage (V)	125
Current (A)	1.520

Reference ballast characteristics

Rated input voltage (V)	350
Reference current (A)	1.500
Impedance (ohms)	197

Cathode characteristics

Type	Low resistance
Resistance (at 3.6 V)	
Objective (ohms)	3.2
Minimum (ohms)	2.0

7881-ANSI-1023-1

Information for ballast design (conditions of clause 12 apply)

Lamp starting requirements

	Single lamp	Ballasts for two lamps	Ballasts for three lamps
Rapid start			
Voltage between lamp terminals (Note 1)			
at 50°F (10°C) and above, (Vrms) min	225	350	500
at 0°F (-17.8°C) and above, (Vrms) min	270	360	500
at -20°F (-28.9°C) and above, (Vrms) min	310	400	535
Voltage lamp terminal to starting aid (Note 2)			
at 50°F (10°C) and above, (Vpeak) min	400	400	400
at 0°F (-17.8°C) and above, (Vpeak) min	575	575	575
at -20°F (-28.9°C) and above, (Vpeak) min	650	650	650
Waveshape of starting voltage crest factor, max	2.0	2.0	2.0
Starting capacitor size			
min (µF) (at 60 Hz)		0.06	0.06
max (µF) (at 60 Hz)		0.12	0.12

NOTES—

- 1 These values are for lead circuits only. For lag circuits, add 10%.
- 2 These values are for crest factors of 1.55 to 2.0. Add 10% for crest factors less than 1.55.

Cathode heat requirements

Rapid start

Voltage	3.6 V nominal
Limits during operation	3.3 V min, 4.3 V max
Dummy load resistor	3.2 ohms ± 0.05 ohm
Voltage across dummy load	3.4 V min, 4.5 V max

7881-ANSI-1023-1

© 2014 National Electrical Manufacturers Association

168-Watt, 72-Inch PG17, 1.5-Ampere, Rapid-Start Fluorescent Lamp

Lamp description

Lamp abbreviation	168W/72PG17/1.5 A
Nominal wattage	168 watts
Nominal overall length	72 in (1800mm)
Bulb designation	TD17 (TD54)
Base	R17d, Recessed double contact
Circuit application	Rapid start, 1.5 A

Dimensional characteristics (definitions of Part II apply)

	<u>Inches</u>		<u>Millimeters</u>	
	<u>Min</u>	<u>Max</u>	<u>Min</u>	<u>Max</u>
C (Ends of opposite base bosses)	69.72	69.91	1770.9	1775.7
D (Bulb, outside diameter)	2.00	2.22	50.8	56.4

Electrical characteristics

Lamp operating characteristics (conditions of clause 11 apply)

Wattage

Arc wattage (W)	161.0
Approximate cathode wattage (with 3.6 V on each cathode) (W)	7.0
Total wattage (W)	168.0
Voltage (V)	125
Current (A)	1.520

Reference ballast characteristics

Rated input voltage (V)	350
Reference current (A)	1.500
Impedance (ohms)	197

Cathode characteristics

Type	Low resistance
Resistance (at 3.6 V)	
Objective (ohms)	3.2
Minimum (ohms)	2.0

7881-ANSI-1024-1

© 2014 National Electrical Manufacturers Association

**168-Watt, 72-Inch PG17, 1.5-Ampere,
Rapid-Start Fluorescent Lamp
Page 2 of 2**

Information for ballast design (conditions of clause 12 apply)

Lamp starting requirements

	<u>Single lamp</u>	<u>Ballasts for two lamps</u>	<u>Ballasts for three lamps</u>
Rapid start			
Voltage between lamp terminals (Note 1)			
at 50°F (10°C) and above, (V _{rms}) min	225	350	500
at 0°F (-17.8°C) and above, (V _{rms}) min	270	360	500
at -20°F (-28.9°C) and above, (V _{rms}) min	310	400	535
Voltage lamp terminal to starting aid (Note 2)			
at 50°F (10°C) and above, (V _{peak}) min	400	400	400
at 0°F (-17.8°C) and above, (V _{peak}) min	575	575	575
at -20°F (-28.9°C) and above, (V _{peak}) min	650	650	650
Waveshape of starting voltage crest factor, max	2.0	2.0	2.0
Starting capacitor size			
min (μF) (at 60 Hz)		0.06	0.06
max (μF) (at 60 Hz)		0.12	0.12

NOTES—

1 These values are for lead circuits only. For lag circuits, add 10%.

2 These values are for crest factors of 1.55 to 2.0. Add 10% for crest factors less than 1.55.

Cathode heat requirements

Rapid start

Voltage	3.6 V nominal
Limits during operation	3.3 V min, 4.3 V max
Dummy load resistor	3.2 ohms ± 0.05 ohm
Voltage across dummy load	3.4 V min, 4.5 V max

7881-ANSI-1024-1

© 2014 National Electrical Manufacturers Association

215-Watt, 96-Inch T12, 1.5-Ampere, Rapid-Start Fluorescent Lamp

Lamp description

Lamp abbreviation	215W/96T12/1.5 A
Nominal wattage	215 watts
Nominal overall length	96 in (2400mm)
Bulb designation	T12 (T38)
Base	R17d, Recessed double contact
Circuit application	Rapid start, 1.5 A

Dimensional characteristics (definitions of Part II apply)

	<u>Inches</u>		<u>Millimeters</u>	
	<u>Min</u>	<u>Max</u>	<u>Min</u>	<u>Max</u>
C (Ends of opposite base bosses)	93.72	93.91	2380.5	2385.3
D (Bulb, outside diameter)	1.41	1.59	35.8	40.4

Electrical characteristics

Lamp operating characteristics (conditions of clause 11 apply)

Wattage	
Arc wattage (W)	208.0
Approximate cathode wattage (with 3.6 V on each cathode) (W)	7.0
Total wattage (W)	215.0
Voltage (V)	163
Current (A)	1.500

Reference ballast characteristics

Rated input voltage (V)	400
Reference current (A)	1.500
Impedance (ohms)	215

Cathode characteristics

Type	Low resistance
Resistance (at 3.6 V)	
Objective (ohms)	3.2
Minimum (ohms)	2.0

7881-ANSI-1025-1

© 2014 National Electrical Manufacturers Association

**215-Watt, 96-Inch T12, 1.5-Ampere,
Rapid-Start Fluorescent Lamp
Page 2 of 2**

Information for ballast design (conditions of clause 12 apply)

Lamp starting requirements

	<u>Single lamp</u>	<u>Ballasts for two lamps</u>	<u>Ballasts for three lamps</u>
Rapid start			
Voltage between lamp terminals (Note 1)			
at 50°F (10°C) and above, (V _{rms}) min	300	470	675
at 0°F (-17.8°C) and above, (V _{rms}) min	355	470	675
at -20°F (-28.9°C) and above, (V _{rms}) min	400	500	690
Voltage lamp terminal to starting aid (Note 2)			
at 50°F (10°C) and above, (V _{peak}) min	400	400	400
at 0°F (-17.8°C) and above, (V _{peak}) min	575	575	575
at -20°F (-28.9°C) and above, (V _{peak}) min	650	650	650
Waveshape of starting voltage crest factor, max	2.0	2.0	2.0
Starting capacitor size			
min (μF) (at 60 Hz)		0.06	0.06
max (μF) (at 60 Hz)		0.12	0.12

NOTES—

1 These values are for lead circuits only. For lag circuits, add 10%.

2 These values are for crest factors of 1.55 to 2.0. Add 10% for crest factors less than 1.55.

Cathode heat requirements

Rapid start

Voltage	3.6 V nominal
Limits during operation	3.3 V min, 4.3 V max
Dummy load resistor	3.2 ohms ± 0.05 ohm
Voltage across dummy load	3.4 V min, 4.5 V max

Additional starting requirements for ballasts for two lamps in series

At 90% of rated line voltage and with the cathode circuits for the ballasts loaded with the specified dummy load resistances, ballast shall supply a minimum of 0.725-A to a 500-ohm noninductive resistor connected across the ballast lamp leads that supply the highest voltage. The measurement shall be made at an ambient temperature of 25°C (77°F).

7881-ANSI-1025-1

© 2014 National Electrical Manufacturers Association

215-Watt, 96-Inch PG17, 1.5-Ampere, Rapid-Start Fluorescent Lamp

Lamp description

Lamp abbreviation	215W/96PG17/1.5 A
Nominal wattage	215 watts
Nominal overall length	96 in (2400mm)
Bulb designation	TD17 (TD54)
Base	R17d, Recessed double contact
Circuit application	Rapid start, 1.5 A

Dimensional characteristics (definitions of Part II apply)

	<u>Inches</u>		<u>Millimeters</u>	
	<u>Min</u>	<u>Max</u>	<u>Min</u>	<u>Max</u>
C (Ends of opposite base bosses)	93.72	93.91	2380.5	2385.3
D (Bulb, outside diameter)	2.00	2.22	50.8	56.4

Electrical characteristics

Lamp operating characteristics (conditions of clause 11 apply)

Wattage

Arc wattage (W)	208.0
Approximate cathode wattage (with 3.6 V on each cathode) (W)	7.0
Total wattage (W)	215.0
Voltage (V)	163
Current (A)	1.500

Reference ballast characteristics

Rated input voltage (V)	400
Reference current (A)	1.500
Impedance (ohms)	215

Cathode characteristics

Type	Low resistance
Resistance (at 3.6 V)	
Objective (ohms)	3.2
Minimum (ohms)	2.0

7881-ANSI-1026-1

© 2014 National Electrical Manufacturers Association

**215-Watt, 96-Inch PG17, 1.5-Ampere,
Rapid-Start Fluorescent Lamp
Page 2 of 2**

Information for ballast design (conditions of clause 12 apply)

Lamp starting requirements

	<u>Single lamp</u>	<u>Ballasts for two lamps</u>	<u>Ballasts for three lamps</u>
Rapid start			
Voltage between lamp terminals (Note 1)			
at 50°F (10°C) and above, (Vrms) min	300	470	675
at 0°F (-17.8°C) and above, (Vrms) min	355	470	675
at -20°F (-28.9°C) and above, (Vrms) min	500	500	690
Voltage lamp terminal to starting aid (Note 2)			
at 50°F (10°C) and above, (Vpeak) min	400	400	400
at 0°F (-17.8°C) and above, (Vpeak) min	575	575	575
at -20°F (-28.9°C) and above, (Vpeak) min	650	650	650
Waveshape of starting voltage crest factor, max	2.0	2.0	2.0
Starting capacitor size			
min (µF) (at 60 Hz)		0.06	0.06
max (µF) (at 60 Hz)		0.12	0.12

NOTES—

- 1 These values are for lead circuits only. For lag circuits, add 10%.
- 2 These values are for crest factors of 1.55 to 2.0. Add 10% for crest factors less than 1.55.

Cathode heat requirements

Rapid start

Voltage	3.6 V nominal
Limits during operation	3.3 V min, 4.3 V max
Dummy load resistor	3.2 ohms ± 0.05 ohm
Voltage across dummy load	3.4 V min, 4.5 V max

Additional starting requirements for ballasts for two lamps in series

At 90% of rated line voltage and with the cathode circuits for the ballasts loaded with the specified dummy load resistances, ballast shall supply a minimum of 0.725-A to a 500-ohm noninductive resistor connected across the ballast lamp leads that supply the highest voltage. The measurement shall be made at an ambient temperature of 25°C (77°F).

7881-ANSI-1026-1

© 2014 National Electrical Manufacturers Association

25-Watt, 48-Inch T12, Rapid-Start Fluorescent Lamp

Lamp description

Lamp abbreviation	25W/48T12/RS
Nominal wattage	25 watts
Nominal overall length	48 in (1200mm)
Bulb designation	T12 (T38)
Base	G13, Medium bipin
Circuit application	Rapid start, Low power factor (Lag) Ballast (Shoplight)

Dimensional characteristics (definitions of Part II apply)

	<u>Inches</u>		<u>Millimeters</u>	
	<u>Min</u>	<u>Max</u>	<u>Min</u>	<u>Max</u>
A (Base face to base face)	-	47.22	-	1199.4
B (Base face to end of opposite base pin)	47.40	47.50	1204.0	1206.5
C (End of base pin to end of opposite pin end)	47.67	47.78	1210.8	1213.6
D (Bulb, outside diameter)	1.41	1.59	35.8	40.4

Electrical characteristics

Lamp operating characteristics (conditions of clause 11 apply)

Wattage	
Arc wattage (W)	24.5
Approximately cathode wattage (with 3.6 V on each cathode) (W)	1.5
Total wattage (W)	26.0
Voltage (V)	106
Current (A)	0.250

Reference ballast characteristics

Rated input voltage (V)	300
Reference current (A)	0.250
Impedance (ohms)	1025

Cathode characteristics

Type	Rapid start
Resistance (at 3.6 V)	
Objective (ohms)	11.5
Minimum (ohms)	9.0

7881-ANSI-1027-1

© 2014 National Electrical Manufacturers Association

Information for ballast design (conditions of clause 12 apply)

Lamp starting requirements

	<u>Single lamp</u>	<u>Ballasts for two lamps</u>	<u>Ballasts for three lamps</u>
Rapid start			
Voltage between lamp terminals (Note 1)			
at 50°F (10°C) and above, (V _{rms}) min	200	256	395
at 50°F (10°C) and above, (V _{rms}) max	260	330	525
Voltage lamp terminal to starting aid (Note 2)			
at 50°F (10°C) and above, (V _{peak}) min	240	240	280
Waveshape of starting voltage crest factor, max	2.0	2.0	2.0
Starting capacitor size			
min (µF) (at 60 Hz)		0.04	0.04
max (µF) (at 60 Hz)		0.06	0.06

Preheat (switch)–start

Voltage between lamp terminals	
at 50°F (10°C) and above, (V _{rms}) min	176
at 50°F (10°C) and above, (V _{rms}) max	230
at 50°F (10°C) and above, (V _{peak}) max	375
Voltage lamp terminal to ground (V _{rms}) max (Note 3)	135

NOTES—

- 1 These values are for lead circuits only. For lag circuits, add 3%.
- 2 These values are for crest factors of 1.55 to 2.0. Add 10% for crest factors less than 1.55.
- 3 Applies unless other means are provided to avoid instant starting.

Cathode heat requirements

Rapid start

Voltage	3.6 V nominal
Limits during operation	2.5 V min, 4.0 V max
Dummy load resistor	11.5 ohms ± 0.1 ohm
Voltage across dummy load	3.4 V min, 4.5 V max

Preheat (switch) start

Current during preheat at rated primary voltage	0.40 A min, 0.65 A max
Preheat time at 0.53 A preheat current	1.0 sec. min

NOTES—

- 1 This lamp is specifically designed for rapid-start low power factor (Lag) ballasts.
- 2 Use on other ballasts, such as rapid-start high power factor F40T12 ballasts, may substantially reduce lamp life.
- 3 The U.S. and Canadian governments are considering restrictions on the marketing and application of 48 in (1200mm) T12 lamps rated at less than 28 watts.

7881-ANSI-1027-1

© 2014 National Electrical Manufacturers Association

25-Watt, 48-Inch T8 Fluorescent Lamp

Lamp Description

Lamp abbreviation	25W/48T8
Nominal wattage	25 watts
HF reference wattage	24 watts
Nominal overall length	48 in (1200mm)
Bulb designation	T8 (T25)
Base	G13, Medium bipin
Circuit application	Instant start, Programmed start

NOTE—The “nominal wattage” of 25W for this lamp reflects common commercial nomenclature. It represents the measured wattage on a 60 Hz reference ballast for 32W/48T8/RS fluorescent lamps. The high frequency (HF) reference wattage of 24W above reflects the measured wattage when operated on the HF reference ballast.

Dimensional characteristics (definitions of Part II apply)

	<u>Inches</u>		<u>Millimeters</u>	
	<u>Min</u>	<u>Max</u>	<u>Min</u>	<u>Max</u>
A (Base face to base face)	-	47.22	-	1199.4
B (Base face to end of opposite base pin)	47.40	47.50	1204.0	1206.5
C (End of base pin to end of opposite pin end)	47.67	47.78	1210.8	1213.6
D (Bulb, outside diameter)	0.94	1.10	23.9	27.9

Electrical Characteristics (with a 25 kHz reference ballast)

Typical lamp electrical characteristics without coil heat will be as follows when the lamp is operated at 25 kHz with a resistive ballast. This represents a reference ballast circuit for HF operation. The following characteristics set the “rated wattage” for this lamp type. The HF reference ballast is specified to provide approximately the same lamp light output as when it is operated on a 60 Hz measurement ballast for 32W/48T8/RS fluorescent lamps with cathode heat.

7881-ANSI-1028-2

© 2014 National Electrical Manufacturers Association

Lamp operating characteristics (conditions of clause 11 apply)

Wattage (W)	24.2
Voltage (V)	105

Reference ballast characteristics

Typical input voltage (V)	466
Current (A)	0.236
Impedance (ohms)	1500
Frequency (kHz)	25

NOTE—The reference ballast characteristics are normative, and lamp current should be set to the indicated value during photometric and electrical measurements per the ANSLG C82.2, C82.3 and C78.375 standards. No cathode heat is applied for the HF reference measurements. The lamp operating characteristics are typical of average lamp performance on the reference ballast.

Cathode characteristics (for heated-cathode starting methods)

Type	Low resistance
Resistance at 3.6 V	12.0 ± 2.0 ohms
R_h/R_c ratio at 3.6 V	4.75 ± 0.50

www.Lisungroup.com

7881-ANSI-1028-2

© 2014 National Electrical Manufacturers Association

**25-Watt, 48-Inch T8
Fluorescent Lamp
Page 3 of 4**

Information for HF ballast design (conditions of clause 12 apply)

Lamp current limits

Minimum design lamp current without cathode heat, I_{rms} (A)	0.155
Maximum design lamp current, I_{rms} (A)	0.320
Maximum lamp current crest factor	1.7

NOTE—Ballasts designed for lamps without cathode heating shall have a design minimum lamp current around 0.155 A. Variation around this design value due to potential tolerances related to components and manufacturing is expected. However, the lamp current shall not be less than 0.140 A under any condition without cathode heating. Further, the lamp current shall not exceed 0.335 A under any operating condition.

Instant start requirements

For lamp use on HF instant-start electronic ballasts.

Lamp starting requirements

Open circuit voltage (min), V_{rms} , $T_{amb} \geq 50^\circ F$	550
Maximum starting time (ms)	100

Programmed start requirements

For lamp use with HF programmed-start ballasts.

Lamp starting requirements

Preheating time	$0.4 \leq t \leq 1.5$ s
R_h/R_c limits defined by	$4.25 \leq R_h/R_c \leq 6.0$
Open circuit voltage (min), V_{rms} , $T_{amb} \geq 50^\circ F$	Under consideration

During preheating

Cathode heating voltage (max), V_{rms}	10
Voltage crest factor (max)	1.7
Lamp glow current (max), I_{rms} (A)	0.010

7881-ANSI-1028-2

© 2014 National Electrical Manufacturers Association

Information for dimming ballast design (Effective January 1, 2015)

For operation at reduced lamp current, the cathode requires supplemental ohmic heating by means of circulating current in the cathode. The following are specifications for the voltage drop, EV, across each cathode in a system of one or more lamps for a range of lamp current, I_D , in dimmed operation.

Maximum heating voltage (V):	$EV_{max} = 5.3$	
Minimum heating voltage (V):	$EV_{min} = 4.0$	for $0.020 \leq I_D < 0.050$ (A)
	$EV_{min} = 5.0 - 20 \cdot I_D$	for $0.050 \leq I_D < 0.100$ (A)
	$EV_{min} = 8.45 - 54.5 \cdot I_D$	for $0.100 \leq I_D < 0.155$ (A)
	$EV_{min} = 0$	for $0.155 \leq I_D$ (A)

www.Lisungroup.com

7881-ANSI-1028-2

© 2014 National Electrical Manufacturers Association

28-Watt, 48-Inch T8 Fluorescent Lamp

Lamp Description

Lamp abbreviation	28W/48T8
Nominal wattage	28 watts
HF reference wattage	26 watts
Nominal overall length	48 in (1200mm)
Bulb designation	T8 (T25)
Base	G13, Medium bipin
Circuit application	Instant start, Programmed start

NOTE—The “nominal wattage” of 28W for this lamp reflects common commercial nomenclature. It represents the measured wattage on a 60 Hz reference ballast for 32W/48T8/RS fluorescent lamps. The high frequency (HF) reference wattage of 26W above reflects the measured wattage when operated on the HF reference ballast.

Dimensional characteristics (definitions of Part II apply)

	Inches		Millimeters	
	Min	Max	Min	Max
A (Base face to base face)	-	47.22	-	1199.4
B (Base face to end of opposite base pin)	47.40	47.50	1204.0	1206.5
C (End of base pin to end of opposite pin end)	47.67	47.78	1210.8	1213.6
D (Bulb, outside diameter)	0.94	1.10	23.9	27.9

Electrical Characteristics (with a 25 kHz reference ballast)

Typical lamp electrical characteristics without coil heat will be as follows when the lamp is operated at 25 kHz with a resistive ballast. This represents a reference ballast circuit for HF operation. The following characteristics set the “rated wattage” for this lamp type. The HF reference ballast is specified to provide approximately the same lamp light output as when it is operated on a 60 Hz measurement ballast for 32W/48T8/RS fluorescent lamps with cathode heat.

7881-ANSI-1029-2

© 2014 National Electrical Manufacturers Association

Lamp operating characteristics (conditions of clause 11 apply)

Wattage (W)	26.0
Voltage (V)	115

Reference ballast characteristics

Typical input voltage (V)	470
Current (A)	0.231
Impedance (ohms)	1500
Frequency (kHz)	25

NOTE—The reference ballast characteristics are normative, and lamp current should be set to the indicated value during photometric and electrical measurements per the ANSLG C82.2, C82.3 and C78.375 standards. No cathode heat is applied for the HF reference measurements. The lamp operating characteristics are typical of average lamp performance on the reference ballast.

Cathode characteristics (for heated-cathode starting methods)

Type	Low resistance
Resistance at 3.6 V	12.0 ± 2.0 ohms
R_h/R_c ratio at 3.6 V	4.75 ± 0.50

www.Lisungroup.com

7881-ANSI-1029-2

© 2014 National Electrical Manufacturers Association

**28-Watt, 48-Inch T8
Fluorescent Lamp
Page 3 of 4**

Information for HF ballast design (conditions of clause 12 apply)

Lamp current limits

Minimum design lamp current without cathode heat, I_{rms} (A)	0.155
Maximum design lamp current, I_{rms} (A)	0.320
Maximum lamp current crest factor	1.7

NOTE—Ballasts designed for lamps without cathode heating shall have a design minimum lamp current around 0.155 A. Variation around this design value due to potential tolerances related to components and manufacturing is expected. However, the lamp current shall not be less than 0.140 A under any condition without cathode heating. Further, the lamp current shall not exceed 0.335 A under any operating condition.

Instant start requirements

For lamp use on HF instant-start electronic ballasts.

Lamp starting requirements

Open circuit voltage (min), V_{rms} , $T_{amb} \geq 50^\circ F$	550
Maximum starting time (ms)	100

Programmed start requirements

For lamp use with HF programmed-start ballasts.

Lamp starting requirements

Preheating time	$0.4 \leq t \leq 1.5$ s
R_h/R_c limits defined by	$4.25 \leq R_h/R_c \leq 6.0$
Open circuit voltage (min), V_{rms} , $T_{amb} \geq 50^\circ F$	Under consideration

During preheating

Cathode heating voltage (max), V_{rms}	10
Voltage crest factor (max)	1.7
Lamp glow current (max), I_{rms} (A)	0.010

7881-ANSI-1029-2

Information for dimming ballast design (Effective January 1, 2015)

For operation at reduced lamp current, the cathode requires supplemental ohmic heating by means of circulating current in the cathode. The following are specifications for the voltage drop, EV, across each cathode in a system of one or more lamps for a range of lamp current, I_D , in dimmed operation.

Maximum heating voltage (V):	$EV_{max} = 5.3$	
Minimum heating voltage (V):	$EV_{min} = 4.0$	for $0.020 \leq I_D < 0.050$ (A)
	$EV_{min} = 5.0 - 20 \cdot I_D$	for $0.050 \leq I_D < 0.100$ (A)
	$EV_{min} = 8.45 - 54.5 \cdot I_D$	for $0.100 \leq I_D < 0.155$ (A)
	$EV_{min} = 0$	for $0.155 \leq I_D$ (A)

www.Lisungroup.com

7881-ANSI-1029-2

© 2014 National Electrical Manufacturers Association

30-Watt, 48-Inch T8 Fluorescent Lamp

Lamp Description

Lamp abbreviation	30W/48T8
Nominal wattage	30 watts
HF reference wattage	28 watts
Nominal overall length	48 in (1200mm)
Bulb designation	T8 (T25)
Base	G13, Medium bipin
Circuit application	Instant start, Programmed start

NOTE—The “nominal wattage” of 30W for this lamp reflects common commercial nomenclature. It represents the measured wattage on a 60 Hz reference ballast for 32W/48T8/RS fluorescent lamps. The high-frequency (HF) reference wattage of 28W above reflects the measured wattage when operated on the HF reference ballast.

Dimensional characteristics (definitions of Part II apply)

	<u>Inches</u>		<u>Millimeters</u>	
	<u>Min</u>	<u>Max</u>	<u>Min</u>	<u>Max</u>
A (Base face to base face)	-	47.22	-	1199.4
B (Base face to end of opposite base pin)	47.40	47.50	1204.0	1206.5
C (End of base pin to end of opposite pin end)	47.67	47.78	1210.8	1213.6
D (Bulb, outside diameter)	0.94	1.10	23.9	27.9

Electrical Characteristics (with a 25 kHz reference ballast)

Typical lamp electrical characteristics without coil heat will be as follows when the lamp is operated at 25 kHz with a resistive ballast. This represents a reference ballast circuit for HF operation. The following characteristics set the “rated wattage” for this lamp type. The HF reference ballast is specified to provide approximately the same lamp light output as when it is operated on a 60 Hz measurement ballast for 32W/48T8/RS fluorescent lamps with cathode heat.

7881-ANSI-1030-2

© 2014 National Electrical Manufacturers Association

Lamp operating characteristics (conditions of clause 11 apply)

Wattage (W)	27.5
Voltage (V)	125

Reference ballast characteristics

Typical input voltage (V)	468
Current (A)	0.223
Impedance (ohms)	1500
Frequency (kHz)	25

NOTE—The reference ballast characteristics are normative, and lamp current should be set to the indicated value during photometric and electrical measurements per the ANSLG C82.2, C82.3 and C78.375 standards. No cathode heat is applied for the HF reference measurements. The lamp operating characteristics are typical of average lamp performance on the reference ballast.

Cathode characteristics (for heated-cathode starting methods)

Type	Low resistance
Resistance at 3.6 V	12.0 ± 2.0 ohms
R_h/R_c ratio at 3.6 V	4.75 ± 0.50

7881-ANSI-1030-2

© 2014 National Electrical Manufacturers Association

**30-Watt, 48-Inch T8
Fluorescent Lamp
Page 3 of 4**

Information for HF ballast design (conditions of clause 12 apply)

Lamp current limits

Minimum design lamp current without cathode heat, I_{rms} (A)	0.155
Maximum design lamp current, I_{rms} (A)	0.320
Maximum lamp current crest factor	1.7

NOTE—Ballasts designed for lamps without cathode heating shall have a design minimum lamp current around 0.155 A. Variation around this design value due to potential tolerances related to components and manufacturing is expected. However, the lamp current shall not be less than 0.140 A under any condition without cathode heating. Further, the lamp current shall not exceed 0.335 A under any operating condition.

Instant start requirements

For lamp use on HF instant-start electronic ballasts.

Lamp starting requirements

Open circuit voltage (min), V_{rms} , $T_{amb} \geq 50^{\circ}F$	550
Maximum starting time (ms)	100

Programmed start requirements

For lamp use with HF programmed-start ballasts.

Lamp starting requirements

Preheating time	$0.4 \leq t \leq 1.5$ s
R_h/R_c limits defined by	$4.25 \leq R_h/R_c \leq 6.0$
Open circuit voltage (min), V_{rms} , $T_{amb} \geq 50^{\circ}F$	Under consideration

During preheating

Cathode heating voltage (max), V_{rms}	10
Voltage crest factor (max)	1.7
Lamp glow current (max), I_{rms} (A)	0.010

7881-ANSI-1030-2

© 2014 National Electrical Manufacturers Association

Information for dimming ballast design (Effective January 1, 2015)

For operation at reduced lamp current, the cathode requires supplemental ohmic heating by means of circulating current in the cathode. The following are specifications for the voltage drop, EV, across each cathode in a system of one or more lamps for a range of lamp current, I_D , in dimmed operation.

Maximum heating voltage (V):	$EV_{max} = 5.3$	
Minimum heating voltage (V):	$EV_{min} = 4.0$	for $0.020 \leq I_D < 0.050$ (A)
	$EV_{min} = 5.0 - 20 \cdot I_D$	for $0.050 \leq I_D < 0.100$ (A)
	$EV_{min} = 8.45 - 54.5 \cdot I_D$	for $0.100 \leq I_D < 0.155$ (A)
	$EV_{min} = 0$	for $0.155 \leq I_D$ (A)

www.Lisungroup.com

7881-ANSI-1030-2

© 2014 National Electrical Manufacturers Association

15-Watt, 18-Inch T8 Fluorescent Lamp

Lamp Description

Lamp abbreviation	15W/18T8
Nominal wattage	15 watts
HF reference wattage	11 watts
Nominal overall length	18 in (450mm)
Bulb designation	T8 (T25)
Base	G13, Medium bipin
Circuit application	Instant start, Programmed start, Rapid start

NOTE—The “nominal wattage” of 15W for this lamp reflects common commercial nomenclature. It represents the measured wattage on a 60 Hz reference ballast for 15W/18T8/RS fluorescent lamps. The 15W/18T8/RS data sheet is recorded in the abeyance list for ANSI C78.81 since November 2005. The high frequency (HF) reference wattage of 11W above reflects the measured wattage when operated on the HF reference ballast.

Dimensional characteristics (definitions of Part II apply)

	<u>Inches</u>		<u>Millimeters</u>	
	<u>Min</u>	<u>Max</u>	<u>Min</u>	<u>Max</u>
A (Base face to base face)	-	17.22	-	437.4
B (Base face to end of opposite base pin)	17.40	17.50	442.0	444.5
C (End of base pin to end of opposite pin end)	17.67	17.78	448.8	451.6
D (Bulb, outside diameter)	0.94	1.10	23.9	27.9

Cathode characteristics (for heated-cathode starting methods)

Type	Low resistance
Resistance at 3.6 V	12.0 ± 2.0 ohms
R _h /R _c ratio at 3.6 V	4.75 ± 0.50

7881-ANSI-1031-1

© 2014 National Electrical Manufacturers Association

Electrical Characteristics (with a 25 kHz reference ballast)

Typical lamp electrical characteristics without coil heat will be as follows when the lamp is operated at 25 kHz with a resistive ballast. This represents a reference ballast circuit for HF operation. The following characteristics set the “rated wattage” for this lamp type. The HF reference ballast is specified to provide approximately the same lamp light output as when it is operated on a 60 Hz measurement ballast for 15W/18T8/RS fluorescent lamps with cathode heat.

Typical lamp operating characteristics (conditions of clause 11 apply)

Wattage (W)	11.0
Voltage (V)	50

Reference ballast characteristics

Typical input voltage (V)	401
Current (A)	0.234
Impedance (ohms)	1500
Frequency (kHz)	25

NOTE—The reference ballast characteristics are normative, and lamp current should be set to the indicated value during photometric and electrical measurements per the ANSLG C82.2, C82.3 and C78.375 standards. No cathode heat is applied for the HF reference measurements. The lamp operating characteristics are typical of average lamp performance on the reference ballast.

www.LisunGroup.com

7881-ANSI-1031-1

© 2014 National Electrical Manufacturers Association

**15-Watt, 18-Inch T8
Fluorescent Lamp
Page 3 of 5**

Information for HF ballast design (conditions of clause 12 apply)

Lamp current limits

Minimum design lamp current without cathode heat, I_{rms} (A)	0.155
Maximum design lamp current, I_{rms} (A)	0.320
Maximum lamp current crest factor	1.7

NOTE—Ballasts designed for lamps without cathode heating shall have a design minimum lamp current around 0.155 A. Variation around this design value due to potential tolerances related to components and manufacturing is expected. However, the lamp current shall not be less than 0.140 A under any condition without cathode heating. Further, the lamp current shall not exceed 0.335 A under any operating condition.

Instant start requirements

For lamp use on HF instant-start electronic ballasts. The requirements shall be met at any primary voltage between 90% and 110% of ballast's rated input voltage.

Lamp starting requirements

Open circuit voltage (min), V_{rms} , $T_{amb} \geq 50^{\circ}F$	465
Open circuit voltage (min), V_{rms} , $-20 F \leq T_{amb} < 50^{\circ}F$	600
Maximum starting time (ms)	100

Programmed start requirements

For lamp use with HF programmed-start ballasts.

Lamp starting requirements

Preheating time	$0.4 \leq t \leq 1.5$ s
R_h/R_c limits defined by	$4.25 \leq R_h/R_c \leq 6.0$
Open circuit voltage (min), V_{rms} , $T_{amb} \geq 50^{\circ}F$	Under consideration

During preheating

Cathode heating voltage (max), V_{rms}	10
Voltage crest factor (max)	1.7
Lamp glow current (max), I_{rms} (A)	0.010

7881-ANSI-1031-1

© 2014 National Electrical Manufacturers Association

Rapid start requirements

For lamp use with HF rapid-start ballasts. The following limits are to be observed during the starting period. The requirements of C82.11 section 5.2.3 apply.

Cathode heat requirements

Voltage maximum during operation, V_{rms} 5.3 V

Information for dimming ballast design (Effective January 1, 2015)

For operation at reduced lamp current, the cathode requires supplemental ohmic heating by means of circulating current in the cathode. The following are specifications for the voltage drop, EV , across each cathode in a system of one or more lamps for a range of lamp current, I_D , in dimmed operation.

Maximum heating voltage (V):	$EV_{max} = 5.3$	
Minimum heating voltage (V):	$EV_{min} = 4.0$	for $0.020 \leq I_D < 0.050$ (A)
	$EV_{min} = 5.0 - 20 \cdot I_D$	for $0.050 \leq I_D < 0.100$ (A)
	$EV_{min} = 8.45 - 54.5 \cdot I_D$	for $0.100 \leq I_D < 0.155$ (A)
	$EV_{min} = 0$	for $0.155 \leq I_D$ (A)

7881-ANSI-1031-1

© 2014 National Electrical Manufacturers Association

**15-Watt, 18-Inch T8
Fluorescent Lamp
Page 5 of 5**

Information for 60 Hz ballast operation

The following information pertains to the former 15W/18T8/RS lamp specification (see C78.81 abeyance list). It is preserved here to allow a smooth transition from operation on 60 Hz ballasts to HF electronic ballasts. Whenever practical, the HF specifications should be used.

Rapid start requirements

	Single <u>lamp</u>	Ballasts for two <u>lamps</u>
Rapid start		
Voltage between lamp terminals (Note 1)		
at 50°F (10°C) and above, (V_{rms}) min	130	190
at 50°F (10°C) and above, (V_{rms}) max	175	255
Voltage lamp terminal to starting aid (Note 2)		
at 50°F (10°C) and above, (V_{peak}) min	325	325
Waveshape of starting voltage crest factor, max	2.0	2.0
Starting capacitor size		
min (μ F) (at 60 Hz)		0.04
max (μ F) (at 60 Hz)		0.06

NOTES—

- 1 These values are for lead circuits only.
- 2 These values are for crest factors of 1.55 to 2.0. Add 20% for crest factors less than 1.55.

Cathode heat requirements – Rapid start

Voltage	3.6 V nominal
Limits during operation	2.5 V min, 4.4 V max
Dummy load resistor	11.0 ohms \pm 0.1 ohm
Voltage across dummy load	3.4 V min, 4.5 V max

7881-ANSI-1031-1

© 2014 National Electrical Manufacturers Association

15-Watt, 24-Inch T8 Fluorescent Lamp

Lamp Description

Lamp abbreviation	15W/24T8
Nominal wattage	15 watts
HF reference wattage	13 watts
Nominal overall length	24 in (600mm)
Bulb designation	T8 (T25)
Base	G13, Medium bipin
Circuit application	Instant start, Programmed start

NOTE—This lamp is an energy-saver version of the former 17W/24T8/RS lamp. It was introduced commercially as a 15W lamp, which represents the measured wattage on a 60 Hz reference ballast for 17W/24T8/RS fluorescent lamps. The high frequency (HF) reference wattage of 13W above reflects the measured wattage when operated on the HF reference ballast.

Dimensional characteristics (definitions of Part II apply)

	<u>Inches</u>		<u>Millimeters</u>	
	<u>Min</u>	<u>Max</u>	<u>Min</u>	<u>Max</u>
A (Base face to base face)	-	23.22	-	589.8
B (Base face to end of opposite base pin)	23.40	23.50	594.4	596.9
C (End of base pin to end of opposite pin end)	23.67	23.78	601.2	604.0
D (Bulb, outside diameter)	0.94	1.10	23.9	27.9

Cathode characteristics (for heated-cathode starting methods)

Type	Low resistance
Resistance at 3.6 V	12.0 ± 2.0 ohms
R _h /R _c ratio at 3.6 V	4.75 ± 0.50

7881-ANSI-1032-1

© 2014 National Electrical Manufacturers Association

**15-Watt, 24-Inch T8
Fluorescent Lamp
Page 2 of 4**

Electrical Characteristics (with a 25 kHz reference ballast)

Typical lamp electrical characteristics without coil heat will be as follows when the lamp is operated at 25 kHz with a resistive ballast. This represents a reference ballast circuit for HF operation. The following characteristics set the “rated wattage” for this lamp type. The HF reference ballast is specified to provide approximately the same lamp light output as when it is operated on a 60 Hz measurement ballast for 17W/24T8/RS fluorescent lamps with cathode heat.

Typical lamp operating characteristics (conditions of clause 11 apply)

Wattage (W)	12.9
Voltage (V)	57

Reference ballast characteristics

Typical input voltage (V)	401
Current (A)	0.230
Impedance (ohms)	1500
Frequency (kHz)	25

NOTE—The reference ballast characteristics are normative, and lamp current should be set to the indicated value during photometric and electrical measurements per the ANSLG C82.2, C82.3 and C78.375 standards. No cathode heat is applied for the HF reference measurements. The lamp operating characteristics are typical of average lamp performance on the reference ballast.

7881-ANSI-1032-1

© 2014 National Electrical Manufacturers Association

Information for HF ballast design (conditions of clause 12 apply)

Lamp current limits

Minimum design lamp current without cathode heat, I_{rms} (A)	0.155
Maximum design lamp current, I_{rms} (A)	0.320
Maximum lamp current crest factor	1.7

NOTE—Ballasts designed for lamps without cathode heating shall have a design minimum lamp current around 0.155 A. Variation around this design value due to potential tolerances related to components and manufacturing is expected. However, the lamp current shall not be less than 0.140 A under any condition without cathode heating. Further, the lamp current shall not exceed 0.335 A under any operating condition.

Instant start requirements

For lamp use on HF instant-start electronic ballasts. The requirements shall be met at any primary voltage between 90% and 110% of ballast's rated input voltage.

Lamp starting requirements

Open circuit voltage (min), V_{rms} , $T_{amb} \geq 50^{\circ}F$	550
Maximum starting time (ms)	100

Programmed start requirements

For lamp use with HF programmed-start ballasts.

Lamp starting requirements

Preheating time	$0.4 \leq t \leq 1.5$ s
R_h/R_c limits defined by	$4.25 \leq R_h/R_c \leq 6.0$
Open circuit voltage (min), V_{rms} , $T_{amb} \geq 50^{\circ}F$	Under consideration

During preheating

Cathode heating voltage (max), V_{rms}	10
Voltage crest factor (max)	1.7
Lamp glow current (max), I_{rms} (A)	0.010

7881-ANSI-1032-1

**15-Watt, 24-Inch T8
Fluorescent Lamp
Page 4 of 4**

Rapid start requirements

For lamp use with HF rapid-start ballasts. The following limits are to be observed during the starting period. The requirements of C82.11 section 5.2.3 apply.

Cathode heat requirements

Voltage maximum during operation, V_{rms} 5.3 V

Information for dimming ballast design (Effective January 1, 2015)

For operation at reduced lamp current, the cathode requires supplemental ohmic heating by means of circulating current in the cathode. The following are specifications for the voltage drop, EV, across each cathode in a system of one or more lamps for a range of lamp current, I_D , in dimmed operation.

Maximum heating voltage (V):	$EV_{max} = 5.3$	
Minimum heating voltage (V):	$EV_{min} = 4.0$	for $0.020 \leq I_D < 0.050$ (A)
	$EV_{min} = 5.0 - 20 * I_D$	for $0.050 \leq I_D < 0.100$ (A)
	$EV_{min} = 8.45 - 54.5 * I_D$	for $0.100 \leq I_D < 0.155$ (A)
	$EV_{min} = 0$	for $0.155 \leq I_D$ (A)

7881-ANSI-1032-1

© 2014 National Electrical Manufacturers Association

21-Watt, 36-Inch T8 Fluorescent Lamp

Lamp Description

Lamp abbreviation	21W/36T8
Nominal wattage	21 watts
HF reference wattage	19 watts
Nominal overall length	36 in (900mm)
Bulb designation	T8 (T25)
Base	G13, Medium bipin
Circuit application	Instant start, Programmed start

NOTE—This lamp is an energy-saver version of the former 25W/36T8/RS lamp. It was introduced commercially as a 22W lamp (with cathode heat) and 21W (without cathode heat), which represents the approximate wattage on a 60 Hz reference ballast for 25W/36T8/RS fluorescent lamps. The high frequency (HF) reference wattage of 19W above reflects the measured wattage when operated on the HF reference ballast.

Dimensional characteristics (definitions of Part II apply)

	<u>Inches</u>		<u>Millimeters</u>	
	<u>Min</u>	<u>Max</u>	<u>Min</u>	<u>Max</u>
A (Base face to base face)	-	35.22	-	894.6
B (Base face to end of opposite base pin)	35.40	35.50	899.2	901.7
C (End of base pin to end of opposite pin end)	35.67	35.78	906.0	908.8
D (Bulb, outside diameter)	0.94	1.10	23.9	27.9

Cathode characteristics (for heated-cathode starting methods)

Type	Low resistance
Resistance at 3.6 V	12.0 ± 2.0 ohms
R _h /R _c ratio at 3.6 V	4.75 ± 0.50

7881-ANSI-1033-1

© 2014 National Electrical Manufacturers Association

**21-Watt, 36-Inch T8
Fluorescent Lamp
Page 2 of 4**

Electrical Characteristics (with a 25 kHz reference ballast)

Typical lamp electrical characteristics without coil heat will be as follows when the lamp is operated at 25 kHz with a resistive ballast. This represents a reference ballast circuit for HF operation. The following characteristics set the “rated wattage” for this lamp type. The HF reference ballast is specified to provide approximately the same lamp light output as when it is operated on a 60 Hz measurement ballast for 25W/36T8/RS fluorescent lamps with cathode heat.

Typical lamp operating characteristics (conditions of clause 11 apply)

Wattage (W)	19.2
Voltage (V)	85

Reference ballast characteristics

Typical input voltage (V)	429
Current (A)	0.231
Impedance (ohms)	1500
Frequency (kHz)	25

NOTE—The reference ballast characteristics are normative, and lamp current should be set to the indicated value during photometric and electrical measurements per the ANSLG C82.2, C82.3 and C78.375 standards. No cathode heat is applied for the HF reference measurements. The lamp operating characteristics are typical of average lamp performance on the reference ballast.

www.LisunGroup.com

7881-ANSI-1033-1

© 2014 National Electrical Manufacturers Association

Information for HF ballast design (conditions of clause 12 apply)

Lamp current limits

Minimum design lamp current without cathode heat, I_{rms} (A)	0.155
Maximum design lamp current, I_{rms} (A)	0.320
Maximum lamp current crest factor	1.7

NOTE—Ballasts designed for lamps without cathode heating shall have a design minimum lamp current around 0.155 A. Variation around this design value due to potential tolerances related to components and manufacturing is expected. However, the lamp current shall not be less than 0.140 A under any condition without cathode heating. Further, the lamp current shall not exceed 0.335 A under any operating condition.

Instant start requirements

For lamp use on HF instant-start electronic ballasts. The requirements shall be met at any primary voltage between 90% and 110% of ballast's rated input voltage.

Lamp starting requirements

Open circuit voltage (min), V_{rms} , $T_{amb} \geq 50^{\circ}F$	550
Maximum starting time (ms)	100

Programmed start requirements

For lamp use with HF programmed-start ballasts.

Lamp starting requirements

Preheating time	$0.4 \leq t \leq 1.5$ s
R_h/R_c limits defined by	$4.25 \leq R_h/R_c \leq 6.0$
Open circuit voltage (min), V_{rms} , $T_{amb} \geq 50^{\circ}F$	Under consideration

During preheating

Cathode heating voltage (max), V_{rms}	10
Voltage crest factor (max)	1.7
Lamp glow current (max), I_{rms} (A)	0.010

7881-ANSI-1033-1

© 2014 National Electrical Manufacturers Association

**21-Watt, 36-Inch T8
Fluorescent Lamp
Page 4 of 4**

Rapid start requirements

For lamp use with HF rapid-start ballasts. The following limits are to be observed during the starting period. The requirements of C82.11 section 5.2.3 apply.

Cathode heat requirements

Voltage maximum during operation, V_{rms} 5.3 V

Information for dimming ballast design (Effective January 1, 2015)

For operation at reduced lamp current, the cathode requires supplemental ohmic heating by means of circulating current in the cathode. The following are specifications for the voltage drop, EV , across each cathode in a system of one or more lamps for a range of lamp current, I_D , in dimmed operation.

Maximum heating voltage (V):	$EV_{max} = 5.3$	
Minimum heating voltage (V):	$EV_{min} = 4.0$	for $0.020 \leq I_D < 0.050$ (A)
	$EV_{min} = 5.0 - 20 \cdot I_D$	for $0.050 \leq I_D < 0.100$ (A)
	$EV_{min} = 8.45 - 54.5 \cdot I_D$	for $0.100 \leq I_D < 0.155$ (A)
	$EV_{min} = 0$	for $0.155 \leq I_D$ (A)

7881-ANSI-1033-1

© 2014 National Electrical Manufacturers Association

86-Watt, 96-Inch T8, 0.4 A HF-Rapid-Start Fluorescent Lamp

Lamp Description

Lamp abbreviation	86W/96T8/HO
Nominal wattage	86 watts
Nominal overall length	96 in (2400mm)
Bulb designation	T8 (T25)
Nominal diameter	1 in (25.4mm)
Base type	RI7d (T8) recessed double contact
Circuit application	HF Rapid start, Preheat start, Programmed start

Dimensional characteristics (definitions of Part II apply)

	Inches		Millimeters	
	Min	Max	Min	Max
C (End of opposite base bosses)	93.72	93.91	2380.5	2385.3
D (Bulb, outside diameter)	0.94	1.10	24.0	27.8

Electrical characteristics

Lamp operating characteristics (conditions of clause 11 apply)

HF (20-26 kHz) (Note 1)

Arc wattage (W)	84.0
Approximate cathode wattage (with 3.6 V on each cathode) (W)	2.0
Total wattage (W)	86.0
Voltage (V)	216.0
Current (A)	0.395

Reference ballast characteristics (20-26 kHz) (Note 1)

Rated input voltage (V)	450
Impedance (ohms)	595
Reference current (A)	0.395

NOTE 1—The above frequency has been chosen for ease of reproducing test results and is not intended to imply the correct frequency range for practical applications.

7881-ANSI-1501-1

© 2014 National Electrical Manufacturers Association

**86-Watt, 96-inch T8, 0.4 A
HF Rapid-Start Fluorescent Lamp
Page 2 of 4**

Cathode characteristics

Hot resistance at test current (ohms)	9.5 ± 1.9
Test current (A) (Note 2)	0.390

NOTE 2—The average value of the resistance ratio, R_h/R_c , of the coils of 10 cathodes shall be within 4.75 ± 0.5 , where R_h is the resistance of the cathode when heated with the test current as specified and R_c is the resistance of the cold cathode, both excluding leadwire resistance.

Information for HF ballast design (where applicable, conditions of clause 11 apply)

Starting

It is recognized that more than one type of circuit can properly start and operate this lamp type. These limits shall be met at any primary voltage between 90% and 110% of rated voltage and will provide reliable starting.

Cathode heating requirements in terms of R_h/R_c

The value of the R_h/R_c ratio immediately prior to lamp starting shall be not less than 4.25 nor greater than 6.5. This is a dynamic value and must be attained by each cathode at the beginning of the transition from glow to operating current. Minimum preheat time must be greater than 400 ms.

Cathode heating requirements in terms of cathode voltage

Time to emission (t_e)	Constant Cathode Voltage	Min	Max
		0.5 Sec	5.1 V
1.0 Sec		4.3 V	7.0 V
1.5 Sec		3.8 V	6.5 V

(See drawing for times other than those specified)

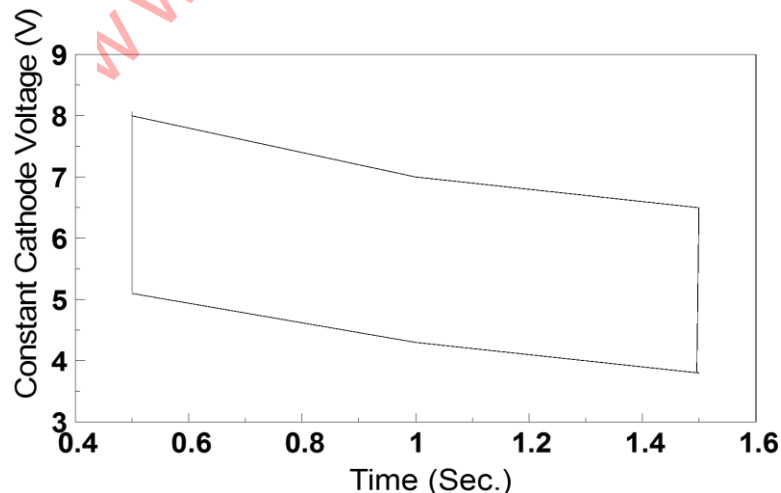

7881-ANSI-1501-1

© 2014 National Electrical Manufacturers Association

Voltage between lamp terminals (Notes 3 and 4)

Time at	Temperature	Open circuit voltage across lamp (V)	
$t \leq t_e$		Max (rms)	300
$t > t_e$	50°F (10°C)	Min (rms)	550
$t > t_e$	0°F (-18°C)	Min (rms)	790
$t > t_e$	-20°F (-29°C)	Min (rms)	875

NOTES—

3 Sinusoidal voltages, frequency 20-26 kHz, with a grounded starting aid plane

4 Ballasts that meet the R_h/R_c preheat requirements are not required to meet the limit on maximum voltage across the lamp during preheat period.

Starting Aid Plane

Maximum distance

1.25 in (32mm)

Operation

Cathode heating requirements during running and dimming conditions:

In an operating lamp at least part of the emissive material has to be kept at a sufficiently high temperature for good lamp performance. Above a certain limiting value, the discharge current itself can take care of this. Below this limit value, additional electrode current has to be applied. See diagram.

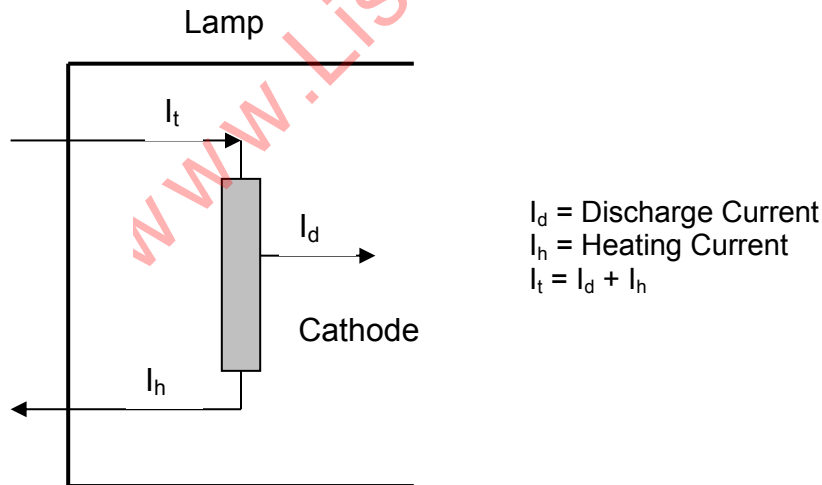

7881-ANSI-1501-1

**86-Watt, 96-inch T8, 0.4 A
HF Rapid-Start Fluorescent Lamp
Page 4 of 4**

	I_d (Note 5)	I_h (Note 6)	I_t (Note 7)
Nominal operation	350-595 mA	<490 mA	350<1<630 mA
Dimming operation	35-350 mA	<490 mA	385<1<630 mA

NOTES—

5 Discharge currents <350 mA require additional electrode heating (I_h). Operation in this lamp current range may not provide ANSI specified ballast factors. Discharge currents >595 mA will have a negative effect on lamp life.

6 Heating currents >490 mA will cause accelerated end blackening.

7 I_t is the highest current measured through any one lead to the electrode. I_t has a maximum value to avoid local overheating of the electrodes. For I_d <350 mA, when extra electrode heating is applied, the minimum electrode heating is covered by the lower limit set to I_t .

Deep Dimming

Dimming with electronic ballasts at a t_d < 35 mA is not yet specified.

Current Crest Factor

Current Crest Factor

<1.70

www.Lisungroup.com

7881-ANSI-1501-1

© 2014 National Electrical Manufacturers Association

44-watt, 48-inch T8, 0.4 A HF Rapid-Start Fluorescent Lamp

Lamp Description

Lamp abbreviation	44W/48T8/HO
Nominal Wattage	44 watts
Nominal overall length	48 in (1200mm)
Bulb designation	T8 (T25)
Nominal diameter	1 in (25.4mm)
Base type	RI7d (T8) Recessed double contact
Circuit application	HF Rapid start, Preheat start, Programmed start

Dimensional characteristics (definitions of Part II apply)

	<u>Inches</u>		<u>Millimeters</u>	
	<u>Min</u>	<u>Max</u>	<u>Min</u>	<u>Max</u>
C (End of opposite base bosses)	45.72	45.91	1161.3	1166.1
D (Bulb, outside diameter)	0.94	1.10	24.0	27.8

Electrical characteristics

Lamp operating characteristics (conditions of clause 11 apply)

	<u>HF (20-26 kHz) (Note 1)</u>
Arc wattage (W)	42.0
Approximate cathode wattage (with 3.6 V on each cathode) (W)	2.0
Total wattage (W)	44.0
Voltage (V)	106.0
Current (A)	0.400

Reference ballast characteristics (20-26 kHz) (Note 1)

Rated input voltage (V)	300
Impedance (ohms)	476
Reference Current (A)	0.400

Cathode Characteristics

Hot resistance at test current (ohms)	9.5 ± 1.9
Test current (A) (Note 2)	0.390

NOTES—

1 The above frequency has been chosen for ease of reproducing test results and is not intended to imply the correct frequency range for practical applications.

2 The average value of the resistance ratio, R_h/R_c , of the coils of 10 cathodes shall be within 4.75 ± 0.5 , where R_h is the resistance of the cathode when heated with the test current as specified and R_c is the resistance of the cold cathode, both excluding leadwire resistance.

7881-ANSI-1502-1

© 2014 National Electrical Manufacturers Association

**44-watt, 48-inch T8, 0.4 A
HF Rapid-Start Fluorescent Lamp
Page 2 of 4**

Information for HF ballast design (where applicable, conditions of clause 12 apply)

Starting

It is recognized that more than one type of circuit can properly start and operate this lamp type. These limits shall be met at any primary voltage between 90% and 110% of rated voltage and will provide reliable starting.

Cathode heating requirements in terms of R_h/R_c

The value of the R_h/R_c ratio immediately prior to lamp starting shall be not less than 4.25 nor greater than 6.5. This is a dynamic value and must be attained by each cathode at the beginning of the transition from glow to operating current. Minimum preheat time must be greater than 400 ms.

Cathode heating requirements in terms of cathode voltage

Time to emission (t_e) Constant Cathode Voltage

	<u>Min</u>	<u>Max</u>
0.5 Sec	5.1 V	8.0 V
1.0 Sec	4.3 V	7.0 V
1.5 Sec	3.8 V	6.5 V

(See drawing for times other than those specified)

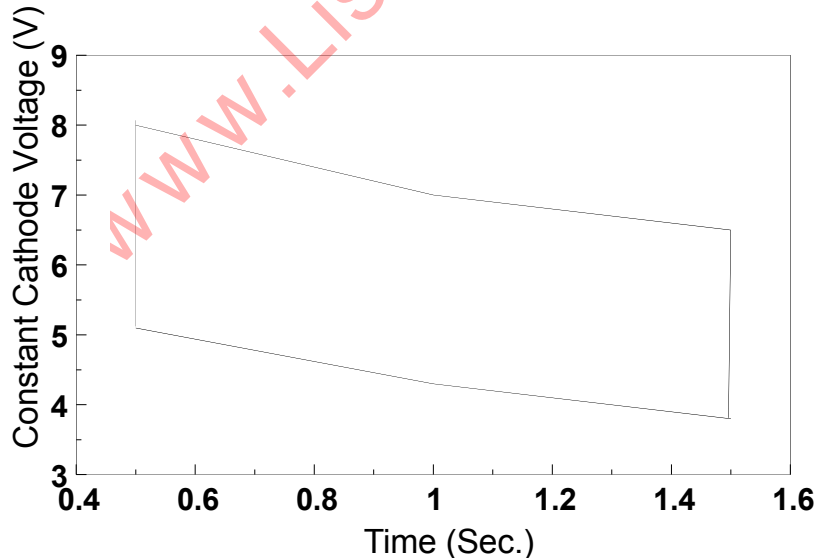

7881-ANSI-1502-1

© 2014 National Electrical Manufacturers Association

Voltage between lamp terminals (Notes 3 and 4)

Time at Temperature	Open circuit voltage across lamp (V)
$t < t_e$	Max (rms) 150
$t > t_e$ 50°F (10°C)	Min (rms) 300
$t > t_e$ 0°F (-18°C)	Min (rms) 375
$t > t_e$ -20°F (-29°C)	Min (rms) 435

NOTES—

- 3 Sinusoidal voltages, frequency 20-26 kHz, with a grounded starting aid plane
- 4 Ballasts that meet the R_h/R_c preheat requirements are not required to meet the limit on maximum voltage across the lamp during preheat period.

Starting Aid Plane

Maximum distance 1.25 in (32mm)

Operation

Cathode heating requirements during running and dimming conditions

In an operating lamp at least part of the emissive material has to be kept at a sufficiently high temperature for good lamp performance. Above a certain limiting value, the discharge current itself can take care of this. Below this limit value, additional electrode current has to be applied. See diagram.

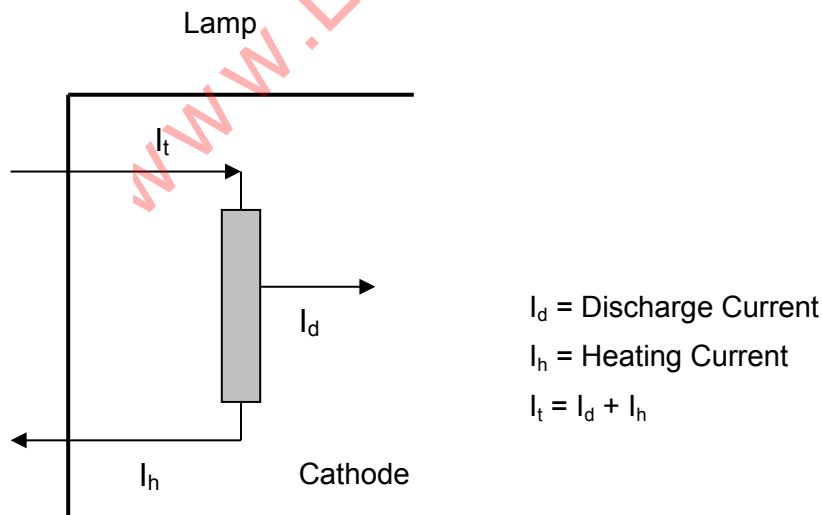

7881-ANSI-1502-1

**44-watt, 48-inch T8, 0.4 A
HF Rapid-Start Fluorescent Lamp
Page 4 of 4**

	I_d (Note 5)	I_h (Note 6)	I_t (Note 7)
Nominal operation	350-595 mA	<490 mA	350<1<630 mA
Dimming operation	35-350 mA	<490 mA	385<1<630 mA

NOTES—

5 Discharge currents <350 mA require additional electrode heating (I_h). Operation in this lamp current range may not provide ANSI-specified ballast factors. Discharge currents >595 mA will have a negative effect on lamp life.

6 Heating currents >490 mA will cause accelerated end blackening.

7 I_t is the highest current measured through any one lead to the electrode. I_t has a maximum value to avoid local overheating of the electrodes. For I_d < 350 mA, when extra electrode heating is applied, the minimum electrode heating is covered by the lower limit set to I_t .

Deep Dimming

Dimming with electronic ballasts at a I_d < 35 mA is not yet specified.

Current Crest Factor

Current Crest Factor

<1.70

7881-ANSI-1502-1

© 2014 National Electrical Manufacturers Association

56-watt, 60-inch T8, 0.4 A HF Rapid-Start Fluorescent Lamp

Lamp Description

Lamp abbreviation	56W/60T8/HO
Nominal Wattage	56 watts
Nominal overall length	60 in (1500mm)
Bulb designation	T8 (T25)
Nominal diameter	1 in (25.4mm)
Base type	RI7d (T8) Recessed double contact
Circuit application	HF Rapid start, Preheat start, Programmed start

Dimensional characteristics (definitions of Part II apply)

	Inches		Millimeters	
	Min	Max	Min	Max
C (End of opposite base bosses)	57.72	57.91	1466.1	1470.9
D (Bulb, outside diameter)	0.94	1.10	24.0	27.8

Electrical characteristics

Lamp operating characteristics (conditions of clause 11 apply)

	HF (20-26 kHz) (Note 1)
Arc wattage (W)	54.0
Approximate cathode wattage (with 3.6 V on each cathode) (W)	2.0
Total wattage (W)	56.0
Voltage (V)	135.0
Current (A)	0.400

Reference ballast characteristics (20-26 kHz) (Note 1)

Rated input voltage (V)	330
Impedance (ohms)	476
Reference Current (A)	0.400

Cathode Characteristics

Hot resistance at test current (ohms)	9.5 ± 1.9
Test current (A) (Note 2)	0.390

NOTES—

- The above frequency has been chosen for ease of reproducing test results and is not intended to imply the correct frequency range for practical applications.
- The average value of the resistance ratio, R_h/R_c , of the coils of 10 cathodes shall be within 4.75 ± 0.5 , where R_h is the resistance of the cathode when heated with the test current as specified and R_c is the resistance of the cold cathode, both excluding leadwire resistance.

7881-ANSI-1503-1

© 2014 National Electrical Manufacturers Association

**56-watt, 60-inch T8, 0.4 A
HF Rapid-Start Fluorescent Lamp
Page 2 of 4**

Information for HF ballast design (where applicable, conditions of clause 12 apply)

Starting

It is recognized that more than one type of circuit can properly start and operate this lamp type. These limits shall be met at any primary voltage between 90% and 110% of rated voltage and will provide reliable starting.

Cathode heating requirements in terms of R_h/R_c

The value of the R_h/R_c ratio immediately prior to lamp starting shall be not less than 4.25 nor greater than 6.5. This is a dynamic value and must be attained by each cathode at the beginning of the transition from glow to operating current. Minimum preheat time must be greater than 400 ms.

Cathode heating requirements in terms of cathode voltage

Time to emission (t_e)	Constant Cathode Voltage	Min	Max
		0.5 Sec	5.1 V
1.0 Sec	4.3 V	7.0 V	
1.5 Sec	3.8 V	6.5 V	

(See drawing for times other than those specified)

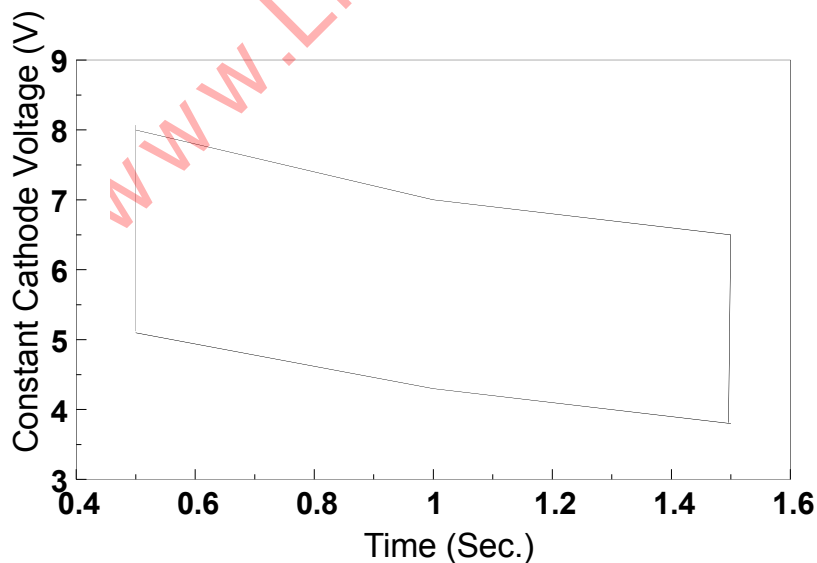

7881-ANSI-1503-1

© 2014 National Electrical Manufacturers Association

Voltage between lamp terminals (Notes 3 and 4)

<u>Time at Temperature</u>	<u>Open circuit voltage across lamp (V)</u>
$t < t_e$	Max (rms) 180
$t > t_e$ 50°F (+10°C)	Min (rms) 350
$t > t_e$ 0°F (-18°C)	Min (rms) 460
$t > t_e$ -20°F (-29°C)	Min (rms) 530

NOTES—

- 3 Sinusoidal voltages, frequency 20-26 kHz, with a grounded starting aid plane.
- 4 Ballasts that meet the R_h/R_c preheat requirements are not required to meet the limit on maximum voltage across the lamp during preheat period.

Starting Aid Plane

Maximum distance 1.25 in (32mm)

Operation

Cathode heating requirements during running and dimming conditions

In an operating lamp at least part of the emissive material has to be kept at a sufficiently high temperature for good lamp performance. Above a certain limiting value, the discharge current itself can take care of this. Below this limit value, additional electrode current has to be applied. See diagram.

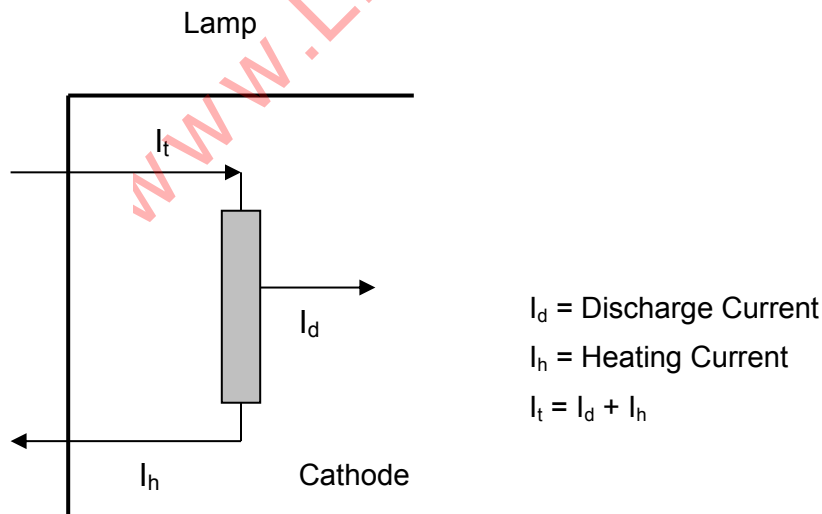

7881-ANSI-1503-1

**56-watt, 60-inch T8, 0.4 A
HF Rapid-Start Fluorescent Lamp
Page 4 of 4**

	I_d (Note 5)	I_h (Note 6)	I_t (Note 7)
Nominal operation	350-595 mA	<490 mA	350<1<630 mA
Dimming operation	35-350 mA	<490 mA	385<1<630 mA

NOTES—

5 Discharge currents <350 mA require additional electrode heating (I_h). Operation in this lamp current range may not provide ANSI specified ballast factors. Discharge currents >595 mA will have a negative effect on lamp life.

6 Heating currents >490 mA will cause accelerated end blackening.

7 I_t is the highest current measured through any one lead to the electrode. I_t has a maximum value to avoid local overheating of the electrodes. For I_d < 350 mA, when extra electrode heating is applied, the minimum electrode heating is covered by the lower limit set to I_t .

Deep Dimming

Dimming with electronic ballasts at a t_d < 35 mA is not yet specified.

Current Crest Factor

Current Crest Factor <1.70

www.Lisungroup.cc

7881-ANSI-1503-1

© 2014 National Electrical Manufacturers Association

66 watt, 72-inch T8, 0.4 A HF Rapid-Start Fluorescent Lamp

Lamp Description

Lamp abbreviation	66W/72T8/HO
Nominal Wattage	66 watts
Nominal overall length	72 in (1800mm)
Bulb designation	T8 (T25)
Nominal diameter	1 in (25.4mm)
Base type	RI7d (T8) Recessed double contact
Circuit application	HF Rapid start, Preheat start, Programmed start

Dimensional characteristics (definitions of Part II apply)

	<u>Inches</u>		<u>Millimeters</u>	
	<u>Min</u>	<u>Max</u>	<u>Min</u>	<u>Max</u>
C (End of opposite base bosses)	69.72	69.91	1770.9	1775.7
D (Bulb, outside diameter)	0.94	1.10	24.0	27.8

Electrical characteristics

Lamp operating characteristics (conditions of clause 11 apply)

	<u>HF (20-26 kHz) (Note 1)</u>
Arc wattage (W)	64.0
Approximate cathode wattage (with 3.6 V on each cathode) (W)	2.0
Total wattage (W)	66.0
Voltage (V)	161.0
Current (A)	0.400

Reference ballast characteristics (20-26 kHz) (Note 1)

Rated input voltage (V)	350
Impedance (ohms)	468
Reference Current (A)	0.400

Cathode Characteristics

Hot resistance at test current (ohms)	9.5 ± 1.9
Test current (A) (Note 2)	0.390

NOTES—

- The above frequency has been chosen for ease of reproducing test results and is not intended to imply the correct frequency range for practical applications.
- The average value of the resistance ratio, R_h/R_c , of the coils of 10 cathodes shall be within 4.75 ± 0.5 , where R_h is the resistance of the cathode when heated with the test current as specified and R_c is the resistance of the cold cathode, both excluding leadwire resistance.

7881-ANSI-1504-1

© 2014 National Electrical Manufacturers Association

**66-watt, 72-inch T8, 0.4 A
HF Rapid-Start Fluorescent Lamp
Page 2 of 4**

Information for HF ballast design (where applicable, conditions of clause 12 apply)

Starting

It is recognized that more than one type of circuit can properly start and operate this lamp type. These limits shall be met at any primary voltage between 90% and 110% of rated voltage and will provide reliable starting.

Cathode heating requirements in terms of R_h/R_c

The value of the R_h/R_c ratio immediately prior to lamp starting shall be not less than 4.25 nor greater than 6.5. This is a dynamic value and must be attained by each cathode at the beginning of the transition from glow to operating current. Minimum preheat time must be greater than 400 ms.

Cathode heating requirements in terms of cathode voltage

Time to emission (t_e) Constant Cathode Voltage

	<u>Min</u>	<u>Max</u>
0.5 Sec	5.1 V	8.0 V
1.0 Sec	4.3 V	7.0 V
1.5 Sec	3.8 V	6.5 V

(See drawing for times other than those specified)

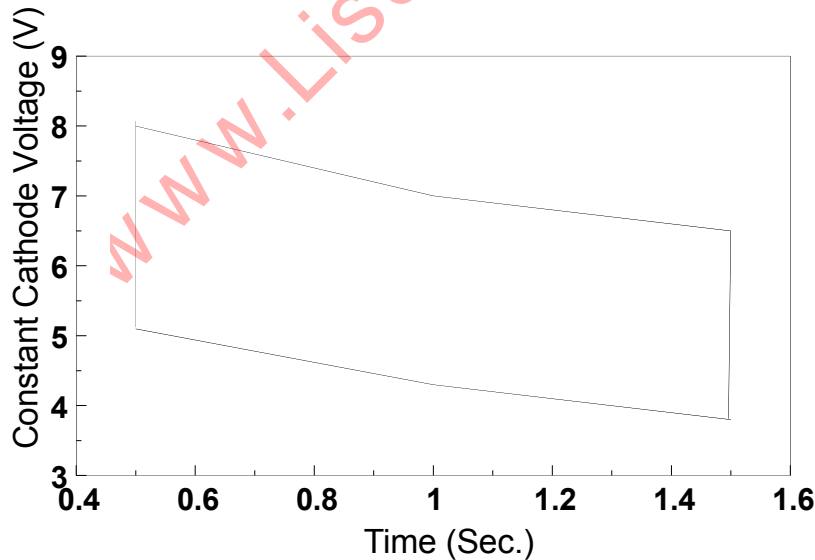

7881-ANSI-1504-1

© 2014 National Electrical Manufacturers Association

Voltage between lamp terminals (Notes 3 and 4)

<u>Time</u>	<u>at Temperature</u>	<u>Open circuit voltage across lamp (V)</u>	
$t < t_e$	Max (rms)	200	
$t > t_e$	50°F (10°C)	Min (rms)	380
$t > t_e$	0°F (-18°C)	Min (rms)	530
$t > t_e$	-20°F (-29°C)	Min (rms)	610

NOTES—

3 Sinusoidal voltages, frequency 20-26 kHz, with a grounded starting aid plane.

4 Ballasts that meet the R_h/R_c preheat requirements are not required to meet the limit on maximum voltage across the lamp during preheat period.

Starting Aid Plane

Maximum distance 1.25 in (32mm)

Operation

Cathode heating requirements during running and dimming conditions

In an operating lamp at least part of the emissive material has to be kept at a sufficiently high temperature for good lamp performance. Above a certain limiting value, the discharge current itself can take care of this. Below this limit value, additional electrode current has to be applied. See diagram.

7881-ANSI-1504-1

© 2014 National Electrical Manufacturers Association

**66 watt, 72-inch T8, 0.4 A
HF Rapid-Start Fluorescent Lamp
Page 4 of 4**

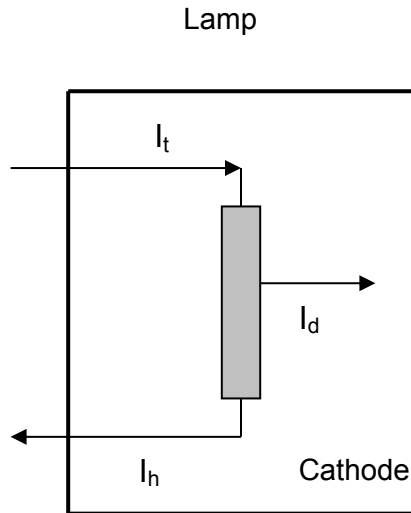

I_d = Discharge Current
 I_h = Heating Current
 $I_t = I_d + I_h$

	I_d (Note 5)	I_h (Note 6)	I_t (Note 7)
Nominal operation	350-595 mA	<490 mA	350<1<630 mA
Dimming operation	35-350 mA	<490 mA	385<1<630 mA

NOTES—

- 5 Discharge currents <350 mA require additional electrode heating (I_h). Operation in this lamp current range may not provide ANSI-specified ballast factors. Discharge currents >595 mA will have a negative effect on lamp life.
- 6 Heating currents >490 mA will cause accelerated end blackening.
- 7 I_t is the highest current measured through any one lead to the electrode. I_t has a maximum value to avoid local overheating of the electrodes. For $I_d < 350$ mA, when extra electrode heating is applied, the minimum electrode heating is covered by the lower limit set to I_t .

Deep Dimming

Dimming with electronic ballasts at a $t_d < 35$ mA is not yet specified.

Current Crest Factor

Current Crest Factor <1.70

7881-ANSI-1504-1

© 2014 National Electrical Manufacturers Association

59-Watt, 96-Inch T8 Single Pin Instant-Start Fluorescent Lamp

Lamp Description

Lamp abbreviation	59W/96T8/IS
Nominal wattage	59 watts
HF reference wattage	57 watts
Nominal overall length	96 in (2400mm)
Bulb designation	T8 (T25)
Base	Fa8, Single Pin
Circuit application	Instant start

NOTE—The “nominal wattage” of 59W for this lamp reflects common commercial nomenclature. It represents the measured wattage on a 60 Hz reference ballast for 59W/96T8/IS fluorescent lamps. The high frequency (HF) reference wattage of 57W above reflects the measured wattage when operated on the HF reference ballast.

Dimensional characteristics (definitions of Part II apply)

	Inches		Millimeters	
	Min	Max	Min	Max
A (Base face to base face)	93.10	93.30	2364.7	2369.8
B (Base face to end of opposite base pin)	93.42	93.65	2372.9	2378.7
C (End of base pin to end of opposite pin end)	93.73	94.00	2381.0	2387.8
D (Bulb, outside diameter)	0.94	1.10	23.9	27.9

Electrical Characteristics (with a 25 kHz reference ballast)

Typical lamp electrical characteristics will be as follows when the lamp is operated at 25 kHz with a resistive ballast. This represents a reference ballast circuit for HF operation. The following characteristics set the “rated wattage” for this lamp type. The HF reference ballast is specified to provide approximately the same lamp light output as when it is operated on a 60 Hz measurement ballast for 59W/96T8/IS fluorescent lamps.

7881-ANSI-1505-2

© 2014 National Electrical Manufacturers Association

**59-Watt, 96-Inch T8 Single Pin
Instant-Start Fluorescent Lamp
Page 2 of 2**

Typical lamp operating characteristics (conditions of clause 11 apply)

Wattage (W)	57.1
Voltage (V)	270

Reference ballast characteristics

Typical input voltage (V)	595
Current (A)	0.215
Impedance (ohms)	1500
Frequency (kHz)	25

NOTE—The reference ballast characteristics are normative, and lamp current should be set to the indicated value during photometric and electrical measurements per the ANSLG C82.2, C82.3 and C78.375 standards. No cathode heat is applied for the HF reference measurements. The lamp operating characteristics are typical of average lamp performance on the reference ballast.

Information for HF ballast design (conditions of clause 12 apply)

Lamp current limits

Minimum design lamp current without cathode heat, I_{rms} (A)	0.155
Maximum design lamp current, I_{rms} (A)	0.320
Maximum lamp current crest factor	1.7

NOTE—Ballasts designed for lamps without cathode heating shall have a design minimum lamp current around 0.155 A. Variation around this design value due to potential tolerances related to components and manufacturing is expected. However, the lamp current shall not be less than 0.140 A under any condition. Further, the lamp current shall not exceed 0.335 A under any operating condition.

Lamp starting requirements

For lamp use on HF instant-start electronic ballasts. The requirements shall be met at any primary voltage between 90% and 110% of ballast's rated input voltage.

Instant starting requirements

Open circuit voltage (min), V_{rms} , $T_{amb} > 50^{\circ}F$	650
Open circuit voltage (min), V_{rms} , $-20 F < T_{amb} < 50^{\circ}F$	950
Maximum starting time (ms)	100

7881-ANSI-1505-2

© 2014 National Electrical Manufacturers Association

4-Watt, 6-Inch T5, Preheat-Start Fluorescent Lamp

This standard data sheet is compatible with IEC 60081.

Lamp description

Lamp abbreviation	4W/6T5/PH
Nominal wattage	4 watts
Nominal overall length	6 in (150mm)
Bulb designation	T5 (T16)
Base	G5, Miniature bipin
Circuit application	Preheat start

Dimensional characteristics (definitions of Part II apply)

	Inches		Millimeters	
	Min	Max	Min	Max
A (Base face to base face)	-	5.35	-	135.9
B (Base face to end of opposite base pin)	5.53	5.63	140.5	143.0
C (End of base pin to end of opposite pin)	-	5.91	-	150.1
D (Bulb outside diameter)	0.53	0.63	13.5	16.0

Electrical characteristics

Lamp operating characteristics (conditions of clause 11 apply)

Wattage (W)	4.5
Voltage (V)	29
Current (A)	0.170

Reference ballast characteristics

Rated input voltage (V)	118
Reference current (A)	0.160
Impedance (ohms)	650

Cathode characteristics

Type	High resistance
Resistance (at 8.0 V)	
Objective (ohms)	70

7881-ANSI-2001-1

© 2014 National Electrical Manufacturers Association

**4-Watt, 6-Inch T5,
Preheat-Start Fluorescent Lamp
Page 2 of 2**

Information for ballast design (conditions of clause 12 apply)

Lamp starting requirements

For preheat (switch)–start circuits

Voltage between lamp terminals	
at 50°F (10°C) and above, (V _{rms}) min	108
at 50°F (10°C) and above, (V _{peak}) max	210
Preheat current	
min (A)	0.16
max (A)	0.25
Preheat time (at 0.22 A preheat current)	
min (seconds)	0.5

For starterless circuits (Rapid start)

	<u>Single lamp</u>	<u>Ballasts for two lamps</u>
Voltage between lamp terminals (see note)		
at 50°F (10°C) and above, (V _{rms}) min	105	120
at 50°F (10°C) and above, (V _{rms}) max	145	165
Voltage lamp terminal to starting aid		
at 50°F (10°C) and above, (V _{peak}) min	400	400
Waveshape of starting voltage crest factor, max	2.0	2.0
Starting capacitor size		
min (μF) (at 60 Hz)		0.008
max (μF) at 60 Hz)		0.06

NOTE—These values are for lead circuits only. For lag circuits, add 3%.

Cathode heat requirements

Voltage, nominal (V)	8.0	
Voltage during operation	<u>Min</u>	<u>Max</u>
at 90% primary (V)	5.4	-
at rated primary (V)	6.0	8.0
at 110% primary (V)	-	8.8
Dummy load resistor	70 ± 1.0 ohm	
Voltage across dummy load	<u>Min</u>	<u>Max</u>
at 90% primary (V)	6.5	-
at rated primary (V)	7.2	8.4
at 110% primary (V)	-	9.2

7881-ANSI-2001-1

© 2014 National Electrical Manufacturers Association

6-Watt, 9-Inch T5, Preheat-Start Fluorescent Lamp

This standard data sheet is compatible with IEC 60081.

Lamp description

Lamp abbreviation	6W/9T5/PH
Nominal wattage	6 watts
Nominal overall length	9 in (225mm)
Bulb designation	T5 (T16)
Base	G5, Miniature bipin
Circuit application	Preheat start

Dimensional characteristics (definitions of Part II apply)

	<u>Inches</u>		<u>Millimeters</u>	
	<u>Min</u>	<u>Max</u>	<u>Min</u>	<u>Max</u>
A (Base face to base face)		8.35	-	212.1
B (Base face to end of opposite base pin)	8.53	8.63	216.7	219.2
C (End of base pin to end of opposite pin)	-	8.91	-	226.3
D (Bulb outside diameter)	0.53	0.63	13.5	16.0

Electrical characteristics

Lamp operating characteristics (conditions of clause 11 apply)

Wattage (W)	6.0
Voltage (V)	42
Current (A)	0.160

Reference ballast characteristics

Rated input voltage (V)	118
Reference current (A)	0.160
Impedance (ohms)	650

Cathode characteristics

Type	High resistance
Resistance (at 8.0 V)	
Objective (ohms)	70

7881-ANSI-2002-1

© 2014 National Electrical Manufacturers Association

**6-Watt, 9-Inch T5,
Preheat-Start Fluorescent Lamp
Page 2 of 2**

Information for ballast design (conditions of clause 12 apply)

Lamp starting requirements

For preheat (switch) start circuits

Voltage between lamp terminals	
at 50°F (10°C) and above, (V _{rms}) min	108
at 50°F (10°C) and above, (V _{peak}) max	210
Preheat current	
min (A)	0.16
max (A)	0.25
Preheat time (at 0.22 A preheat current)	
min (seconds)	0.5

For starterless circuits (Rapid start)

	<u>Single lamp</u>	<u>Ballasts for two lamps</u>
Voltage between lamp terminals (see note)		
at 50°F (10°C) and above, (V _{rms}) min	105	130
at 50°F (10°C) and above, (V _{rms}) max	145	180
Voltage lamp terminal to starting aid		
at 50°F (10°C) and above, (V _{peak}) min	400	400
Waveshape of starting voltage crest factor, max	2.0	2.0
Starting capacitor size		
min (μF) (at 60 Hz)		0.008
max (μF) (at 60 Hz)		0.06

NOTE—These values are for lead circuits only. For lag circuits, add 3%.

Cathode heat requirements

Voltage, nominal (V)	8.0	
Voltage during operation	<u>Min</u>	<u>Max</u>
at 90% primary (V)	5.4	-
at rated primary (V)	6.0	8.0
at 110% primary (V)	-	8.8
Dummy load resistor	70 ± 1.0 ohm	
Voltage across dummy load	<u>Min</u>	<u>Max</u>
at 90% primary (V)	6.5	-
at rated primary (V)	7.2	8.4
at 110 % primary (V)	-	9.2

7881-ANSI-2002-1

© 2014 National Electrical Manufacturers Association

8-Watt, 12-Inch T5, Preheat-Start Fluorescent Lamp

This standard data sheet is compatible with IEC 60081.

Lamp description

Lamp abbreviation	8W/12T5/PH
Nominal wattage	8 watts
Nominal overall length	12 in (300mm)
Bulb designation	T5 (T16)
Base	G5, Miniature bipin
Circuit application	Preheat start

Dimensional characteristics (definitions of Part II apply)

	<u>Inches</u>		<u>Millimeters</u>	
	<u>Min</u>	<u>Max</u>	<u>Min</u>	<u>Max</u>
A (Base face to base face)	-	11.35	-	288.3
B (Base face to end of opposite base pin)	11.53	11.63	292.9	295.4
C (End of base pin to end of opposite pin)	-	11.91	-	302.5
D (Bulb outside diameter)	0.53	0.63	13.5	16.0

Electrical characteristics

Lamp operating characteristics (conditions of clause 11 apply)

Wattage (W)	7.2
Voltage (V)	57
Current (A)	0.145

Reference ballast characteristics

Rated input voltage (V)	118
Reference current (A)	0.160
Impedance (ohms)	650

Cathode characteristics

Type	High resistance
Resistance (at 8.0 V)	
Objective (ohms)	70

7881-ANSI-2003-1

© 2014 National Electrical Manufacturers Association

**8-Watt, 12-Inch T5,
Preheat-Start Fluorescent Lamp
Page 2 of 2**

Information for ballast design (conditions of clause 12 apply)

Lamp starting requirements

For preheat (switch)–start circuits

Voltage between lamp terminals	
at 50°F (10°C) and above, (V _{rms}) min	108
at 50°F (10°C) and above, (V _{peak}) max	210
Preheat current	
min (A)	0.16
max (A)	0.25
Preheat time (at 0.22 A preheat current)	
min (seconds)	0.5

For starterless circuits (Rapid start)

	<u>Single lamp</u>	<u>Ballasts for two lamps</u>
Voltage between lamp terminals (see note)		
at 50°F (10°C) and above, (V _{rms}) min	105	140
at 50°F (10°C) and above, (V _{rms}) max	145	190
Voltage lamp terminal to starting aid		
at 50°F (10°C) and above, (V _{peak}) min	400	400
Waveshape of starting voltage crest factor, max	2.0	2.0
Starting capacitor size		
min (μF) (at 60 Hz)		0.008
max (μF) (at 60 Hz)		0.06

NOTE—These values are for lead circuits only. For lag circuits, add 3%.

Cathode heat requirements

Voltage, nominal (V)	8.0	
Voltage during operation	<u>Min</u>	<u>Max</u>
at 90 primary (V)	5.4	-
at rated primary (V)	6.0	8.0
at 110% primary (V)	-	8.8
Dummy load resistor	70 ± 1.0 ohm	
Voltage across dummy load	<u>Min</u>	<u>Max</u>
at 90% primary (V)	6.5	-
at rated primary (V)	7.2	8.4
at 110% primary (V)	-	9.2

7881-ANSI-2003-1

© 2014 National Electrical Manufacturers Association

8-Watt, 12-Inch T5, Preheat-Start Bactericidal Lamp

Lamp description

Lamp abbreviation	8W/12T5/PH-B
Nominal wattage	8 watts
Nominal overall length	12 in (300mm)
Bulb designation	T5 (T16)
Base	G5, Miniature bipin
Circuit application	Preheat start

Dimensional characteristics (definitions of Part II apply)

	<u>Inches</u>		<u>Millimeters</u>	
	<u>Min</u>	<u>Max</u>	<u>Min</u>	<u>Max</u>
A (Base face to base face)	-	11.35	-	288.3
B (Base face to end of opposite base pin)	11.53	11.63	292.9	295.4
C (End of base pin to end of opposite pin)		11.91	-	302.5
D (Bulb outside diameter)	0.53	0.63	13.5	16.0

Electrical characteristics

Lamp operating characteristics (conditions of clause 11 apply)

Wattage (W)	7.2
Voltage (V)	57
Current (A)	0.145

Reference ballast characteristics

Rated input voltage (V)	118
Reference current (A)	0.160
Impedance (ohms)	650

Cathode characteristics

Type	High resistance
Resistance (at 8.0 V)	
Objective (ohms)	70

7881-ANSI-2004-1

© 2014 National Electrical Manufacturers Association

**8-Watt, 12-Inch T5,
Preheat-Start Bactericidal Lamp
Page 2 of 2**

Information for ballast design (conditions of clause 12 apply)

Lamp starting requirements

For preheat (switch)–start circuits

Voltage between lamp terminals	
at 50°F (10°C) and above, (V _{rms}) min	108
at 50°F (10°C) and above, (V _{peak}) max	210
Preheat current	
min (A)	0.16
max (A)	0.25
Preheat time (at 0.22 A preheat current)	
min (seconds)	0.5

www.Lisungroup.cc

7881-ANSI-2004-1

© 2014 National Electrical Manufacturers Association

13-Watt, 21-Inch T5, Preheat-Start Fluorescent Lamp

This standard data sheet is compatible with IEC 60081.

Lamp description

Lamp abbreviation	13W/21T5/PH
Nominal wattage	13 watts
Nominal overall length	21 in (525mm)
Bulb designation	T5 (T16)
Base	G5, Miniature bipin
Circuit application	Preheat start

Dimensional characteristics (definitions of Part II apply)

	<u>Inches</u>		<u>Millimeters</u>	
	<u>Min</u>	<u>Max</u>	<u>Min</u>	<u>Max</u>
A (Base face to base face)	-	20.35	-	516.9
B (Base face to end of opposite base pin)	20.53	20.63	521.5	524.0
C (End of base pin to end of opposite pin)	-	20.91	-	531.1
D (Bulb outside diameter)	0.53	0.63	13.5	16.0

Electrical characteristics

Lamp operating characteristics (conditions of clause 11 apply)

Wattage (W)	13
Voltage (V)	94
Current (A)	0.165

Reference ballast characteristics

Rated input voltage (V)	236
Reference current (A)	0.165
Impedance (ohms)	1200

Cathode characteristics

Type	High resistance
Resistance (at 8.0 V)	
Objective (ohms)	70

7881-ANSI-2005-1

© 2014 National Electrical Manufacturers Association

**13-Watt, 21-Inch T5,
Preheat-Start Fluorescent Lamp
Page 2 of 2**

Information for ballast design (conditions of clause 12 apply)

Lamp starting requirements

For preheat (switch)–start circuits

Voltage between lamp terminals	
at 50°F (10°C) and above, (V _{rms}) min	180
at 50°F (10°C) and above, (V _{peak}) max	400
Preheat current	
min (A)	0.18
max (A)	0.27
Preheat time (at 0.22 A preheat current)	
min (seconds)	0.5

www.Lisungroup.cc

7881-ANSI-2005-1

© 2014 National Electrical Manufacturers Association

14-Watt, 15-Inch T8, Preheat-Start Fluorescent Lamp

Lamp description

Lamp abbreviation	14W/15T8/PH
Nominal wattage	14 watts
Nominal overall length	15 in (378mm)
Bulb designation	T8 (T25)
Base	G13, Medium bipin
Circuit application	Preheat start

Dimensional characteristics (definitions of Part II apply)

	<u>Inches</u>		<u>Millimeters</u>	
	<u>Min</u>	<u>Max</u>	<u>Min</u>	<u>Max</u>
A (Base face to base face)	-	14.22	-	361.2
B (Base face to end of opposite base pin)	14.40	14.50	365.8	368.3
C (End of base pin to end of opposite pin)	14.67	14.78	372.6	375.4
D (Bulb outside diameter)	0.94	1.10	23.9	27.9

Electrical characteristics

Lamp operating characteristics (conditions of clause 11 apply)

Wattage (W)	14.5
Voltage (V)	45
Current (A)	0.365

Reference ballast characteristics

Rated input voltage (V)	118
Reference current (A)	0.390
Impedance (ohms)	275

Cathode characteristics

Type	High resistance
Resistance (at 8.0 V)	
Objective (ohms)	26

7881-ANSI-2006-1

© 2014 National Electrical Manufacturers Association

**14-Watt, 15-Inch T8,
Preheat-Start Fluorescent Lamp
Page 2 of 2**

Information for ballast design (conditions of clause 12 apply)

Lamp starting requirements

For preheat (switch)–start circuits

Voltage between lamp terminals	
at 50°F (10°C) and above, (V _{rms}) min	108
at 50°F (10°C) and above, (V _{peak}) max	210
Preheat current	
min (A)	0.44
max (A)	0.65
Preheat time (at 0.55 A preheat current)	
min (seconds)	0.75

For starterless circuits (Rapid start)

	Single lamp	Ballasts for two lamps
Voltage between lamp terminals (see note 1)		
at 50°F (10°C) and above, (V _{rms}) min	105	157
at 50°F (10°C) and above, (V _{rms}) max	145	220
Voltage lamp terminal to starting aid (see note 2)		
at 50°F (10°C) and above, (V _{peak}) min	325	325
Waveshape of starting voltage crest factor, max	2.0	2.0
Starting capacitor size		
min (μF) (at 60 Hz)		0.008
max (μF) (at 60 Hz)		0.06

NOTES—

- 1 These values are for lead circuits only. For lag circuits, add 3%.
- 2 These values are for crest factors of 1.55 to 2.0. Add 10% for crest factors less than 1.55.

Cathode heat requirements

Voltage, nominal (V)		8.0
Voltage during operation	<u>Min</u>	<u>Max</u>
at 90% primary (V)	4.0	-
at rated primary (V)	-	8.5
at 100% primary (V)	-	9.5
Dummy load resistor		26 ± 0.25 ohms
Voltage across dummy load	<u>Min</u>	<u>Max</u>
at 90% primary (V)	6.8	-
at rated primary (V)	-	9.0 ¹
at 100% primary (V)	-	10.0 ¹

NOTE 1—This voltage may be exceeded provided that at 110% primary the current through a 14-ohm resistor does not exceed 0.750 amperes.

7881-ANSI-2006-1

© 2014 National Electrical Manufacturers Association

14-Watt, 15-Inch T12, Preheat-Start Fluorescent Lamp

Lamp description

Lamp abbreviation	14W/15T12/PH
Nominal wattage	14 watts
Nominal overall length	15 in (378mm)
Bulb designation	T12 (T38)
Base	G13, Medium bipin
Circuit application	Preheat start

Dimensional characteristics (definitions of Part II apply)

	<u>Inches</u>		<u>Millimeters</u>	
	<u>Min</u>	<u>Max</u>	<u>Min</u>	<u>Max</u>
A (Base face to base face)	-	14.22	-	361.2
B (Base face to end of opposite base pin)	14.40	14.50	365.8	368.3
C (End of base pin to end of opposite pin)	14.67	14.78	372.6	375.4
D (Bulb outside diameter)	1.41	1.59	35.8	40.4

Electrical characteristics

Lamp operating characteristics (conditions of clause 11 apply)

Wattage (W)	14.0
Voltage (V)	40
Current (A)	0.380

Reference ballast characteristics

Rated input voltage (V)	118
Reference current (A)	0.390
Impedance (ohms)	275

Cathode characteristics

Type	High resistance
Resistance (at 8.0 V)	
Objective (ohms)	29

7881-ANSI-2007-1

© 2014 National Electrical Manufacturers Association

**14-Watt, 15-Inch T12,
Preheat-Start Fluorescent Lamp
Page 2 of 2**

Information for ballast design (conditions of clause 12 apply)

Lamp starting requirements

For preheat (switch)–start circuits

Voltage between lamp terminals	
at 50°F (10°C) and above, (V _{rms}) min	108
at 50°F (10°C) and above, (V _{peak}) max	210
Preheat current	
min (A)	0.44
max (A)	0.65
Preheat time (at 0.55 A preheat current)	
min (seconds)	0.75

For starterless circuits (Rapid start)

	<u>Single Lamp</u>	<u>Ballasts for two lamps</u>
Voltage between lamp terminals (see note 1)		
at 50°F (10°C) and above, (V _{rms}) min	105	157
at 50°F (10°C) and above, (V _{rms}) max	145	220
Voltage lamp terminal to starting aid (see note 2)		
at 50°F (10°C) and above, (V _{peak}) min	280	280
Waveshape of starting voltage crest factor, max	2.0	2.0
Starting capacitor size		
min (µF) (at 60 Hz)		0.008
max (µF) (at 60 Hz)		0.06

NOTES—

- 1 These values are for lead circuits only. For lag circuits, add 3%.
- 2 These values are for crest factors of 1.55 to 2.0. Add 10% for crest factors less than 1.55.

Cathode heat requirements

Voltage, nominal (V)	8.0	
Voltage during operation	<u>Min</u>	<u>Max</u>
at 90% primary (V)	4.0	-
at rated primary (V)	-	8.5
at 100% primary (V)	-	9.5
Dummy load resistor	29 ± 0.3 ohms	
Voltage across dummy load	<u>Min</u>	<u>Max</u>
at 90% primary (V)	6.8	-
at rated primary (V)	-	9.0 ¹
at 100% primary (V)	-	10.0 ¹

NOTE 1—This voltage may be exceeded provided that at 110% primary the current through a 14-ohm resistor does not exceed 0.750 amperes.

7881-ANSI-2007-1

© 2014 National Electrical Manufacturers Association

15 Watt, 18-Inch T8, Preheat-Start Fluorescent Lamp

This standard data sheet is compatible with IEC 60081.

Lamp description

Lamp abbreviation	15W/18T8/PH
Nominal wattage	15 watts
Nominal overall length	18 in (450mm)
Bulb Designation	T8 (T25)
Base	G13, Medium bipin
Circuit application	Preheat start

Dimensional characteristics (definitions of Part II apply)

	<u>Inches</u>		<u>Millimeters</u>	
	<u>Min</u>	<u>Max</u>	<u>Min</u>	<u>Max</u>
A (Base face to base face)	-	17.22	-	437.4
B (Base face to end of opposite base pin)	17.40	17.50	442.0	444.5
C (End of base pin to end of opposite pin)	17.67	17.78	448.8	451.6
D (Bulb outside diameter)	0.94	1.10	23.9	27.9

Electrical characteristics

Lamp operating characteristics (conditions of clause 11 apply)

Wattage(W)	15.0
Voltage (V)	55
Current (A)	0.305

Reference ballast characteristics

Rated input voltage (V)	118
Reference current (A)	0.300
Impedance (ohms)	305

Cathode characteristics

Type	High resistance
Resistance (at 8.0 V)	
Objective (ohms)	26

7881-ANSI-2008-1

© 2014 National Electrical Manufacturers Association

**15-Watt, 18-Inch T8,
Preheat-Start Fluorescent Lamp
Page 2 of 2**

Information for ballast design (conditions of clause 12 apply)

Lamp starting requirements

For preheat (switch)–start circuits

Voltage between lamp terminals	
at 50°F (10°C) and above, (V _{rms}) min	108
at 50°F (10°C) and above, (V _{peak}) max	210
Preheat current	
min (A)	0.44
max (A)	0.65
Preheat time (at 0.55 A preheat current)	
min (seconds)	0.75

For starterless circuits (Rapid start)

	<u>Single lamp</u>	<u>Ballasts for two lamps</u>
Voltage between lamp terminals (see note 1)		
at 50°F (10°C) and above, (V _{rms}) min	105	157
at 50°F (10°C) and above, (V _{rms}) max	145	220
Voltage lamp terminal to starting aid (see note 2)		
at 50°F (10°C) and above, (V _{peak}) min	325	325
Waveshape of starting voltage crest factor, max	2.0	2.0
Starting capacitor size		
min (μF) (at 60 Hz)		0.008
max (μF) (at 60 Hz)		0.06

NOTES—

1 These values are for lead circuits only. For lag circuits, add 3%.

2 These values are for crest factors of 1.55 to 2.0. Add 10% for crest factors less than 1.55.

Cathode heat requirements

Voltage, nominal (V)	8.0	
Voltage during operation	<u>Min</u>	<u>Max</u>
at 90% primary (V)	4.0	-
at rated primary (V)	-	8.5
at 100% primary (V)	-	9.5
Dummy load resistor	26 ± 0.25 ohms	
Voltage across dummy load	<u>Min</u>	<u>Max</u>
at 90% primary (V)	6.8	-
at rated primary (V)	-	9.0 ¹
at 100% primary (V)	-	10.0 ¹

NOTE 1—This voltage may be exceeded provided that at 110% primary the current through a 14-ohm resistor does not exceed 0.750 amperes.

7881-ANSI-2008-1

© 2014 National Electrical Manufacturers Association

15-Watt, 18-Inch T8, Preheat-Start Bactericidal Lamp

Lamp description

Lamp abbreviation	15W/18T8/PH-B
Nominal wattage	15 watts
Nominal overall length	18 in (450mm)
Bulb designation	T8 (T25)
Base	G13, Medium bipin
Circuit application	Preheat start

Dimensional characteristics (definitions of Part II apply)

	<u>Inches</u>		<u>Millimeters</u>	
	<u>Min</u>	<u>Max</u>	<u>Min</u>	<u>Max</u>
A (Base face to base face)	-	17.22	-	437.4
B (Base face to end of opposite base pin)	17.40	17.50	442.0	444.5
C (End of base pin to end of opposite pin)	17.67	17.78	448.8	451.6
D (Bulb outside diameter)	0.94	1.10	23.9	27.9

Electrical characteristics

Lamp operating characteristics (conditions of clause 11 apply)

Wattage (W)	15.0
Voltage (V)	55
Current (A)	0.305

Reference ballast characteristics

Rated input voltage (V)	118
Reference current (A)	0.300
Impedance (ohms)	305

Cathode characteristics

Type	High resistance
Resistance (at 8.0 V) Objective (ohms)	26

7881-ANSI-2009-1

© 2014 National Electrical Manufacturers Association

**15-Watt, 18-Inch T8
Preheat-Start Bactericidal Lamp
Page 2 of 2**

Information for ballast design (conditions of clause 12 apply)

Lamp starting requirements

For preheat (switch)–start circuits

Voltage between lamp terminals	
at 50°F (10°C) and above, (V _{rms}) min	106
at 50°F (10°C) and above, (V _{peak}) max	210
Preheat current	
min (A)	0.44
max (A)	0.65
Preheat time (at 0.55 A preheat current)	
min (seconds)	0.75

www.Lisungroup.cc

7881-ANSI-2009-1

© 2014 National Electrical Manufacturers Association

15-Watt, 18-Inch T12, Preheat-Start Fluorescent Lamp

Lamp description

Lamp abbreviation	15W/18T12/PH
Nominal wattage	15 watts
Nominal overall length	18 in (450mm)
Bulb designation	T12 (T38)
Base	G13, Medium bipin
Circuit application	Preheat start

Dimensional characteristics (definitions of Part II apply)

	<u>Inches</u>		<u>Millimeters</u>	
	<u>Min</u>	<u>Max</u>	<u>Min</u>	<u>Max</u>
A (Base face to base face)	-	17.22	-	437.3
B (Base face to end of opposite base pin)	17.40	17.50	442.0	444.5
C (End of base pin to end of opposite pin)	17.67	17.78	448.8	451.6
D (Bulb outside diameter)	1.41	1.59	35.8	40.4

Electrical characteristics

Lamp operating characteristics (conditions of clause 11 apply)

Wattage (W)	14.5
Voltage (V)	47
Current (A)	0.325

Reference ballast characteristics

Rated input voltage (V)	118
Reference current (A)	0.300
Impedance (ohms)	305

Cathode characteristics

Type	High resistance
Resistance (at 8.0 V)	
Objective (ohms)	29

7881-ANSI-2010-1

© 2014 National Electrical Manufacturers Association

**15-Watt, 18-Inch T12,
Preheat-Start Fluorescent Lamp
Page 2 of 2**

Information for ballast design (conditions of clause 12 apply)

Lamp starting requirements

For preheat (switch)–start circuits

Voltage between lamp terminals	
at 50°F (10°C) and above, (V _{rms}) min	108
at 50°F (10°C) and above, (V _{peak}) max	210
Preheat current	
min (A)	0.44
max (A)	0.65
Preheat time (at 0.55 A preheat current)	
min (seconds)	0.75

For starterless circuits (Rapid start)

	<u>Single lamp</u>	<u>Ballasts for two lamps</u>
Voltage between lamp terminals (see note 1)		
at 50°F (10°C) and above, (V _{rms}) min	105	157
at 50°F (10°C) and above, (V _{rms}) max	145	220
Voltage lamp terminal to starting aid (see note 2)		
at 50°F (10°C) and above, (V _{peak}) min	280	280
Waveshape of starting voltage crest factor, max	2.0	2.0
Starting capacitor size		
min (μF) (at 60 Hz)		0.008
max (μF) (at 60 Hz)		0.06

NOTES—

- 1 These values are for lead circuits only. For lag circuits, add 3%.
- 2 These values are for crest factors of 1.55 to 2.0. Add 10% for crest factors less than 1.55.

Cathode heat requirements

Voltage, nominal (V)	8.0	
Voltage during operation	<u>Min</u>	<u>Max</u>
at 90% primary (V)	4.0	-
at rated primary (V)	-	8.5
at 100% primary (V)	-	9.5
Dummy load resistor	29 ± 0.3 ohms	
Voltage across dummy load	<u>Min</u>	<u>Max</u>
at 90% primary (V)	6.8	-
at rated primary (V)	-	9.0 ¹
at 100% primary (V)	-	10.0 ¹

NOTE 1—This voltage may be exceeded provided that at 110% primary the current through a 14-ohm resistor does not exceed 0.750 amperes.

7881-ANSI-2010-1

© 2014 National Electrical Manufacturers Association

18-Watt, 24-Inch T8, Preheat-Start Fluorescent Lamp

This standard data sheet is compatible with IEC 60081.

Lamp description

Lamp abbreviation	18W/24T8/PH
Nominal wattage	18 watts
Nominal overall length	24 in (600mm)
Bulb designation	T8 (T25)
Base	G13, Medium bipin
Circuit application	Preheat start

Dimensional characteristics (definitions of Part II apply)

	<u>Inches</u>		<u>Millimeters</u>	
	<u>Min</u>	<u>Max</u>	<u>Min</u>	<u>Max</u>
A (Base face to base face)	-	23.22	-	589.8
B (Base face to end of opposite base pin)	23.40	23.50	594.4	596.9
C (End of base pin to end of opposite pin)	23.67	23.78	601.2	604.0
D (Bulb outside diameter)	0.94	1.10	23.9	27.9

Electrical characteristics

Lamp operating characteristics (conditions of clause 11 apply)

Wattage (W)	17.5
Voltage (V)	55
Current (A)	0.385

Reference ballast characteristics

Rated input voltage (V)	118
Reference current (A)	0.380
Impedance (ohms)	240

Cathode characteristics

Type	High resistance
------	-----------------

7881-ANSI-2011-1

© 2014 National Electrical Manufacturers Association

**18-Watt, 24-Inch T8,
Preheat-Start Fluorescent Lamp
Page 2 of 2**

Information for ballast design (conditions of clause 12 apply)

Lamp starting requirements

For preheat (switch)–start circuits

Voltage between lamp terminals	
at 50°F (10°C) and above, (V _{rms}) min	108
at 50°F (10°C) and above, (V _{peak}) max	210
Preheat current at 90%-110% primary voltage	
min (A)	0.35
max (A)	0.80
Preheat time (at 0.55 A preheat current)	
min (seconds)	0.75

For this lamp, a grounded metal starting aid is required.

www.Lisungroup.cc

7881-ANSI-2011-1

© 2014 National Electrical Manufacturers Association

18 Watt, 26-Inch T8, Preheat-Start Fluorescent Lamp

Lamp description

Lamp abbreviation	18W/26T8/PH
Nominal wattage	18 watts
Nominal overall length	26 in (650mm)
Bulb designation	T8 (T25)
Base	G13, Medium bipin
Circuit application	Preheat start

Dimensional characteristics (definitions of Part II apply)

	<u>Inches</u>		<u>Millimeters</u>	
	<u>Min</u>	<u>Max</u>	<u>Min</u>	<u>Max</u>
A (Base face to base face)	-	25.22	-	640.6
B (Base face to end of opposite base pin)	25.40	25.50	645.2	647.7
C (End of base pin to end of opposite pin)	25.67	25.78	652.0	654.8
D (Bulb outside diameter)	0.94	1.10	23.9	27.9

Electrical characteristics

Lamp operating characteristics (conditions of clause 11 apply)

Wattage (W)	18.0
Voltage (V)	56
Current (A)	0.380

Reference ballast characteristics

Rated input voltage (V)	118
Reference current (A)	0.380
Impedance (ohms)	240

Cathode characteristics

Type	High resistance
------	-----------------

7881-ANSI-2012-1

© 2014 National Electrical Manufacturers Association

**18-Watt, 26-Inch T8,
Preheat-Start Fluorescent Lamp
Page 2 of 2**

Information for ballast design (conditions of clause 12 apply)

Lamp starting requirements

For preheat (switch)–start circuits

Voltage between lamp terminals	
at 50°F (10°C) and above, (V _{rms}) min	108
at 50°F (10°C) and above, (V _{peak}) max	210
Preheat current at 90%-110% primary voltage	
min (A)	0.35
max (A)	0.80
Preheat time (at 0.55 A preheat current)	
min (seconds)	0.75

For this lamp, a grounded metal starting aid is required.

www.Lisungroup.cc

7881-ANSI-2012-1

© 2014 National Electrical Manufacturers Association

19-Watt, 28-Inch T8, Preheat-Start Fluorescent Lamp

Lamp description

Lamp abbreviation	19W/28T8/PH
Nominal wattage	19 watts
Nominal overall length	28 in (700mm)
Bulb designation	T8 (T25)
Base	G13, Medium bipin
Circuit application	Preheat start

Dimensional characteristics (definitions of Part II apply)

	<u>Inches</u>		<u>Millimeters</u>	
	<u>Min</u>	<u>Max</u>	<u>Min</u>	<u>Max</u>
A (Base face to base face)	-	27.22	-	691.4
B (Base face to end of opposite base pin)	27.40	27.50	696.0	698.5
C (End of base pin to end of opposite pin)	27.67	27.78	702.8	705.6
D (Bulb outside diameter)	0.94	1.10	23.9	27.9

Electrical characteristics

Lamp operating characteristics (conditions of clause 11 apply)

Wattage (W)	19.0
Voltage (V)	62
Current (A)	0.355

Reference ballast characteristics

Rated input voltage (V)	118
Reference current (A)	0.380
Impedance (ohms)	240

Cathode characteristics

Type	High resistance
------	-----------------

7881-ANSI-2013-1

© 2014 National Electrical Manufacturers Association

**19-Watt, 28-Inch T8,
Preheat-Start Fluorescent Lamp
Page 2 of 2**

Information for ballast design (conditions of clause 12 apply)

Lamp starting requirements

For preheat (switch)–start circuits

Voltage between lamp terminals	
at 50°F (10°C) and above, (V _{rms}) min	108
at 50°F (10°C) and above, (V _{peak}) max	210
Preheat current at 90%-110% primary voltage	
min (A)	0.35
max (A)	0.80
Preheat time (at 0.55 A preheat current)	
min (seconds)	0.75

For this lamp, a grounded metal starting aid is required.

www.Lisungroup.cc

7881-ANSI-2013-1

© 2014 National Electrical Manufacturers Association

19-Watt, 30-Inch T8, Preheat-Start Fluorescent Lamp

Lamp description

Lamp abbreviation	19W/30T8/PH
Nominal wattage	19 watts
Nominal overall length	30 in (750mm)
Bulb designation	T8 (T25)
Base	G13, Medium bipin
Circuit application	Preheat start

Dimensional characteristics (definitions of Part II apply)

	<u>Inches</u>		<u>Millimeters</u>	
	<u>Min</u>	<u>Max</u>	<u>Min</u>	<u>Max</u>
A (Base face to base face)	-	29.22	-	742.2
B (Base face to end of opposite base pin)	29.40	29.50	746.8	749.3
C (End of base pin to end of opposite pin)	29.67	29.78	753.6	756.4
D (Bulb outside diameter)	0.94	1.10	23.9	27.9

Electrical characteristics

Lamp operating characteristics (conditions of clause 11 apply)

Wattage (W)	19.0
Voltage (V)	66
Current (A)	0.345

Reference ballast characteristics

Rated input voltage (V)	118
Reference current (A)	0.380
Impedance (ohms)	240

Cathode characteristics

Type	High resistance
------	-----------------

7881-ANSI-2014-1

© 2014 National Electrical Manufacturers Association

**19-Watt, 30-Inch T8,
Preheat-Start Fluorescent Lamp
Page 2 of 2**

Information for ballast design (conditions of clause 12 apply)

Lamp starting requirements

For preheat (switch)–start circuits

Voltage between lamp terminals	
at 50°F (10°C) and above, (V _{rms}) min	108
at 50°F (10°C) and above, (V _{peak}) max	210
Preheat current at 90%-110% primary voltage	
min (A)	0.35
max (A)	0.80
Preheat time (at 0.55 A preheat current)	
min (seconds)	0.75

For this lamp, a grounded metal starting aid is required.

www.Lisungroup.cc

7881-ANSI-2014-1

© 2014 National Electrical Manufacturers Association

20-Watt, 24-Inch T12, Preheat-Start Fluorescent Lamp

This standard data sheet is compatible with IEC 60081.

Lamp description

Lamp abbreviation	20W/24T12/PH
Nominal wattage	20 watts
Nominal overall length	24 in (600mm)
Bulb designation	T12 (T38)
Base	G13, Medium bipin
Circuit application	Preheat start

Dimensional characteristics (definitions of Part II apply)

	Inches		Millimeters	
	Min	Max	Min	Max
A (Base face to base face)	-	23.22	-	589.8
B (Base face to end of opposite base pin)	23.40	23.50	594.4	596.9
C (End of base pin to end of opposite pin)	23.67	23.78	601.2	604.0
D (Bulb outside diameter)	1.41	1.59	35.8	40.4

Electrical characteristics

Lamp operating characteristics (conditions of clause 11 apply)

Wattage (W)	20.5
Voltage (V)	57
Current (A)	0.380

Reference ballast characteristics

Rated input voltage (V)	118
Reference current (A)	0.380
Impedance (ohms)	240

Cathode characteristics

Type	High resistance
Resistance (at 8.0 V)	
Objective (ohms)	29

7881-ANSI-2015-1

© 2014 National Electrical Manufacturers Association

**20-Watt, 24-Inch T12,
Preheat-Start Fluorescent Lamp
Page 2 of 2**

Information for ballast design (conditions of clause 12 apply)

Lamp starting requirements

For preheat (switch)–start circuits

Voltage between lamp terminals	
at 50°F (10°C) and above, (V _{rms}) min	108
at 50°F (10°C) and above, (V _{peak}) max	210
Preheat current	
min (A)	0.44
max (A)	0.65
Preheat time (at 0.55 A preheat current)	
min (seconds)	0.75

For starterless circuits (Rapid start)

	<u>Single Lamp</u>	<u>Ballasts for two lamps</u>
Voltage between lamp terminals (see note 1)		
at 50°F (10°C) and above, (V _{rms}) min	105	157
at 50°F (10°C) and above, (V _{rms}) max	145	220
Voltage lamp terminal to starting aid (see note 2)		
at 50°F (10°C) and above, (V _{peak}) min	280	280
Waveshape of starting voltage crest factor, max	2.0	2.0
Starting capacitor size		
min (μF) (at 60 Hz)		0.008
max (μF) (at 60 Hz)		0.06

NOTES—

1 These values are for lead circuits only. For lag circuits, add 3%.

2 These values are for crest factors of 1.55 to 2.0. Add 10% for crest factors less than 1.55.

Cathode heat requirements

Voltage, nominal (V)	8.0	
Voltage during operation	<u>Min</u>	<u>Max</u>
at 90% primary (V)	4.0	-
at rated primary (V)	-	8.5
at 100% primary (V)	-	9.5
Dummy load resistor	29 ± 0.3 ohms	
Voltage across dummy load	<u>Min</u>	<u>Max</u>
at 90% primary (V)	6.8	-
at rated primary (V)	-	9.0 ¹
at 100% primary (V)	-	10.0 ¹

NOTE 1—This voltage may be exceeded provided that at 110% primary the current through a 14-ohm resistor does not exceed 0.750 amperes.

7881-ANSI-2015-1

© 2014 National Electrical Manufacturers Association

25-Watt, 28-Inch T12, Preheat-Start Fluorescent Lamp

Lamp description

Lamp abbreviation	25W/28T12/PH
Nominal wattage	25 watts
Nominal overall length	28 in (700mm)
Bulb designation	T12 (T38)
Base	G13, Medium bipin
Circuit application	Preheat start

Dimensional characteristics (definitions of Part II apply)

	Inches		Millimeters	
	Min	Max	Min	Max
A (Base face to base face)	-	27.22	-	691.4
B (Base face to end of opposite base pin)	27.40	27.50	696.0	698.5
C (End of base pin to end of opposite pin)	27.67	27.78	702.8	705.6
D (Bulb outside diameter)	1.41	1.59	35.8	40.4

Electrical characteristics

Lamp operating characteristics (conditions of clause 11 apply)

Wattage (W)	25.0
Voltage (V)	63
Current (A)	0.460

Reference ballast characteristics

Rated input voltage (V)	118
Reference current (A)	0.460
Impedance (ohms)	190

Cathode characteristics

Type	High resistance
------	-----------------

7881-ANSI-2016-1

© 2014 National Electrical Manufacturers Association

**25-Watt, 28-Inch T12,
Preheat-Start Fluorescent Lamp
Page 2 of 2**

Information for ballast design (conditions of clause 12 apply)

Lamp starting requirements

For preheat (switch)–start circuits

Voltage between lamp terminals	
at 50°F (10°C) and above, (V _{rms}) min	108
at 50°F (10°C) and above, (V _{peak}) max	210
Preheat current at 90%-110% primary voltage	
min (A)	0.41
max (A)	0.95
Preheat time (at 0.60 A preheat current)	
min (seconds)	0.75

www.Lisungroup.cc

7881-ANSI-2016-1

© 2014 National Electrical Manufacturers Association

25-Watt, 33-Inch T12, Preheat-Start Fluorescent Lamp

Lamp description

Lamp abbreviation	25W/33T12/PH
Nominal wattage	25 watts
Nominal overall length	33 in (825mm)
Bulb designation	T12 (T38)
Base	G13, Medium bipin
Circuit application	Preheat start

Dimensional characteristics (definitions of Part II apply)

	<u>Inches</u>		<u>Millimeters</u>	
	<u>Min</u>	<u>Max</u>	<u>Min</u>	<u>Max</u>
A (Base face to base face)	-	32.22	-	818.4
B (Base face to end of opposite base pin)	32.40	32.50	823.0	825.5
C (End of base pin to end of opposite pin)	32.67	32.78	829.8	832.6
D (Bulb outside diameter)	1.41	1.59	35.8	40.4

Electrical characteristics

Lamp operating characteristics (conditions of clause 11 apply)

Wattage (W)	25.5
Voltage (V)	61
Current (A)	0.460

Reference ballast characteristics

Rated input voltage (V)	118
Reference current (A)	0.460
Impedance (ohms)	190

Cathode characteristics

Type	High resistance
------	-----------------

7881-ANSI-2017-1

© 2014 National Electrical Manufacturers Association

**25-Watt, 33-Inch T12,
Preheat-Start Fluorescent Lamp
Page 2 of 2**

Information for ballast design (conditions of clause 12 apply)

Lamp starting requirements

For preheat (switch)–start circuits

Voltage between lamp terminals	
at 50°F (10°C) and above, (Vrms) min	108
at 50°F (10°C) and above, (Vpeak) max	210
Preheat current at 90%-110% primary voltage	
min (A)	0.41
max (A)	0.95
Preheat time (at 0.60 A preheat current)	
min (seconds)	0.75

www.Lisungroup.cc

7881-ANSI-2017-1

© 2014 National Electrical Manufacturers Association

30-Watt, 36-Inch T8, Preheat-Start Fluorescent Lamp

This standard data sheet is compatible with IEC 60081.

Lamp description

Lamp abbreviation	30W/36T8/PH
Nominal wattage	30 watts
Nominal overall length	36 in (900mm)
Bulb designation	T8 (T25)
Base	G13, Medium bipin
Circuit application	Preheat start

Dimensional characteristics (definitions of Part II apply)

	<u>Inches</u>		<u>Millimeters</u>	
	<u>Min</u>	<u>Max</u>	<u>Min</u>	<u>Max</u>
A (Base face to base face)	-	35.22	-	894.6
B (Base face to end of opposite base pin)	35.40	35.50	899.2	901.7
C (End of base pin to end of opposite pin)	35.67	35.78	906.0	908.8
D (Bulb outside diameter)	0.94	1.10	23.9	27.9

Electrical characteristics

Lamp operating characteristics (conditions of clause 11 apply)

Wattage (W)	30.5
Voltage (V)	99
Current (A)	0.355

Reference ballast characteristics

Rated input voltage (V)	236
Reference current (A)	0.350
Impedance (ohms)	548

Cathode characteristics

Type	High resistance
------	-----------------

7881-ANSI-2018-1

© 2014 National Electrical Manufacturers Association

**30-Watt, 36-Inch T8,
Preheat-Start Fluorescent Lamp
Page 2 of 2**

Information for ballast design (conditions of clause 12 apply)

Lamp starting requirements

For preheat (switch)–start circuits

Voltage between lamp terminals	
at 50°F (10°C) and above, (Vrms) min	176
at 50°F (10°C) and above, (Vpeak) max	375
Preheat current	
min (A)	0.40
max (A)	0.65
Preheat time (at 0.53 A preheat current)	
min (seconds)	1.0

www.Lisungroup.cc

7881-ANSI-2018-1

© 2014 National Electrical Manufacturers Association

30-Watt, 36-Inch T8, Preheat-Start Bactericidal Lamp

Lamp description

Lamp abbreviation	30W/36T8/PH-B
Nominal wattage	30 watts
Nominal overall length	36 in (900mm)
Bulb designation	T8 (T25)
Base	G13, medium bipin
Circuit application	Preheat start

Dimensional characteristics (definitions of Part II apply)

	<u>Inches</u>		<u>Millimeters</u>	
	<u>Min</u>	<u>Max</u>	<u>Min</u>	<u>Max</u>
A (Base face to base face)	-	35.22	-	894.6
B (Base face to end of opposite base pin)	35.40	35.50	899.2	901.7
C (End of base pin to end of opposite pin)	35.67	35.78	906.0	908.8
D (Bulb outside diameter)	0.94	1.10	23.9	27.9

Electrical characteristics

Lamp operating characteristics (conditions of clause 11 apply)

Wattage (W)	30.5
Voltage (V)	99
Current (A)	0.355

Reference ballast characteristics

Rated input voltage (V)	236
Reference current (A)	0.350
Impedance (ohms)	548

Cathode characteristics

Type	High resistance
------	-----------------

7881-ANSI-2019-1

© 2014 National Electrical Manufacturers Association

**30-Watt, 36-Inch T8,
Preheat-Start Bactericidal Lamp
Page 2 of 2**

Information for ballast design (conditions of clause 12 apply)

Lamp starting requirements

For preheat (switch)–start circuits

Voltage between lamp terminals	
at 50°F (10°C) and above, (V _{rms}) min	176
at 50°F (10°C) and above, (V _{peak}) max	375
Preheat current	
min (A)	0.40
max (A)	0.65
Preheat time (at 0.53 A preheat current)	
min (seconds)	1.0

www.Lisungroup.cc

7881-ANSI-2019-1

© 2014 National Electrical Manufacturers Association

90-Watt, 60-Inch T12, Preheat-Start Fluorescent Lamp

Lamp description

Lamp abbreviation	90W/60T12/PH
Nominal wattage	90 watts
Nominal overall length	60 in (1500mm)
Bulb designation	T12 (T38)
Base	G20, Mogul bipin
Circuit application	Preheat start

Dimensional characteristics (definitions of Part II apply)

	<u>Inches</u>		<u>Millimeters</u>	
	<u>Min</u>	<u>Max</u>	<u>Min</u>	<u>Max</u>
A (Base face to base face)	-	58.30	-	1480.8
B (Base face to end of opposite base pin)	58.72	58.93	1491.5	1496.8
C (End of base pin to end of opposite pin)	-	59.56	-	1512.8
D (Bulb outside diameter)	1.41	1.59	35.8	40.4

Electrical characteristics

Lamp operating characteristics (conditions of clause 11 apply)

Wattage (W)	90
Voltage (V)	65
Current (A)	1.5

Reference ballast characteristics

Rated input voltage (V)	150
Reference current (A)	1.50
Impedance (ohms)	78.5

Cathode characteristics

Type	High resistance
------	-----------------

7881-ANSI-2020-1

© 2014 National Electrical Manufacturers Association

**90-Watt, 60-Inch T12,
Preheat-Start Fluorescent Lamp
Page 2 of 2**

Information for ballast design (conditions of clause 12 apply)

Lamp starting requirements

For preheat (switch)–start circuits

	<u>Single lamp</u>	<u>Ballasts for two lamps</u>
Voltage between lamp terminals		
at 50°F (10°C) and above, (V _{rms}) min	132	(see note)
at 50°F (10°C) and above, (V _{peak}) max	350	450
Preheat current		
min (A)	1.45	
max (A)	2.20	
Preheat time (at 1.80 A preheat current)		
min (seconds)	2.0	

NOTE—These lamps, when operated two in series are suitable for operation at voltages provided by the usual 265-277 V power sources (nominal 480 V, 3-phase, 4-wire system) in conjunction with series-type ballasts.

7881-ANSI-2020-1

© 2014 National Electrical Manufacturers Association

90-Watt, 60-Inch T17, Preheat-Start Fluorescent Lamp

Lamp description

Lamp abbreviation	90W/60T17/PH
Nominal wattage	90 watts
Nominal overall length	60 in (1500mm)
Bulb designation.	T17 (T54)
Base	G20, Mogul bipin
Circuit application	Preheat start

Dimensional characteristics (definitions of Part II apply)

	Inches		Millimeters	
	Min	Max	Min	Max
A (Base face to base face)	-	58.30	-	1480.8
B (Base face to end of opposite base pin)	58.72	58.93	1491.5	1496.8
C (End of base pin to end of opposite pin)	-	59.56	-	1512.8
D (Bulb outside diameter)	2.00	2.19	50.8	55.6

Electrical characteristics

Lamp operating characteristics (conditions of clause 11 apply)

Wattage (W)	90
Voltage (V)	65
Current (A)	1.5

Reference ballast characteristics

Rated input voltage (V)	150
Reference current (A)	1.50
Impedance (ohms)	78.5

Cathode characteristics

Type	High resistance
------	-----------------

7881-ANSI-2021-1

© 2014 National Electrical Manufacturers Association

**90-Watt, 60-Inch T17,
Preheat-Start Fluorescent Lamp
Page 2 of 2**

Information for ballast design (conditions of clause 12 apply)

Lamp starting requirements

For preheat (switch)–start circuits

	<u>Single lamp</u>	<u>Ballasts for two lamps in series</u>
Voltage between lamp terminals		
at 50°F (10°C) and above, (V _{rms}) min	132	(see note)
at 50°F (10°C) and above, (V _{peak}) max	350	450
Preheat current		
min (A)	1.45	
max (A)	2.20	
Preheat time (at 1.80 A preheat current)		
min (seconds)	2.0	

NOTE—These lamps, when operated two in series are suitable for operation at voltages provided by the usual 265-277 V power sources (nominal 480 V, 3-phase, 4-wire system) in conjunction with series-type ballasts.

7881-ANSI-2021-1

© 2014 National Electrical Manufacturers Association

40-Watt, 48-Inch T12, Medium Bipin, Instant-Start Fluorescent Lamp

Lamp description

Lamp abbreviation	40W/48T12/IS
Nominal wattage	40 watts
Nominal overall length	48 in (1200mm)
Bulb designation	T12 (T38)
Base	G13, Medium bipin
Circuit application	Instant start

Dimensional characteristics (definitions of Part II apply)

	<u>Inches</u>		<u>Millimeters</u>	
	<u>Min</u>	<u>Max</u>	<u>Min</u>	<u>Max</u>
A (Base face to base face)	-	47.22	-	1199.4
B (Base face to end of opposite base pin)	47.40	47.50	1204.1	1206.5
C (End of base pin to end of opposite pin end)	47.67	47.78	1210.8	1213.6
D (Bulb outside diameter)	1.41	1.59	35.8	40.4

Electrical characteristics

Lamp operating characteristics (conditions of clause 11 apply)

Wattage (W)	40.5
Voltage (V)	104
Current (A)	0.425

Reference ballast characteristics

Rated input voltage (V)	430
Reference current (A)	0.425
Impedance (ohms)	930

Information for ballast design (conditions of clause 12 apply)

Lamp starting requirements

Voltage	
at 50°F (10°C) and above, (Vrms) min	385

7881-ANSI-3001-1

© 2014 National Electrical Manufacturers Association

40-Watt, 60-Inch T12, Mogul Bipin, Instant-Start Fluorescent Lamp

Lamp description

Lamp abbreviation	40W/60T12/IS
Nominal wattage	40 watts
Nominal overall length	60 in (1500mm)
Bulb designation	T12 (T38)
Base	G20, Mogul bipin
Circuit Application	Instant start

Dimensional characteristics (definitions of Part II apply)

	<u>Inches</u>		<u>Millimeters</u>	
	<u>Min</u>	<u>Max</u>	<u>Min</u>	<u>Max</u>
A (Base face to base face)	-	58.30	-	1480.8
B (Base face to end of opposite base pin)	58.72	58.93	1491.5	1496.8
C (End of base pin to end of opposite pin end)	59.34	59.56	1507.2	1512.8
D (Bulb outside diameter)	1.41	1.59	35.8	40.4

Electrical characteristics

Lamp operating characteristics (conditions of clause 11 apply)

Wattage (W)	42
Voltage (V)	107
Current (A)	0.425

Reference ballast characteristics

Rated input voltage (V)	430
Reference current (A)	0.425
Impedance (ohms)	930

Information for ballast design (conditions of clause 12 apply)

Lamp starting requirements

Voltage	
at 50°F (10°C) and above, (Vrms) min	385

7881-ANSI-3002-1

© 2014 National Electrical Manufacturers Association

40-Watt, 60-Inch T17, Mogul Bipin, Instant-Start Fluorescent Lamp

Lamp description

Lamp abbreviation	40W/60T17/IS
Nominal wattage	40 watts
Nominal overall length	60 in (1500mm)
Bulb designation	T17 (T54)
Base	G20, Mogul bipin
Circuit application	Instant start

Dimensional characteristics (definitions of Part II apply)

	<u>Inches</u>		<u>Millimeters</u>	
	<u>Min</u>	<u>Max</u>	<u>Min</u>	<u>Max</u>
A (Base face to base face)	-	58.30	-	1480.8
B (Base face to end of opposite base pin)	58.72	58.93	1491.5	1496.8
C (End of base pin to end of opposite pin end)	59.34	59.56	1507.2	1512.8
D (Bulb outside diameter)	2.00	2.19	50.8	55.5

Electrical characteristics

Lamp operating characteristics (conditions of clause 11 apply)

Wattage (W)	42
Voltage (V)	107
Current (A)	0.425

Reference ballast characteristics

Rated input voltage (V)	430
Reference current (A)	0.425
Impedance (ohms)	930

Information for ballast design (conditions of clause 12 apply)

Lamp starting requirements

Voltage	
at 50°F (10°C) and above, (Vrms) min	385

7881-ANSI-3003-1

© 2014 National Electrical Manufacturers Association

40-Watt, 48-Inch T12, Single Pin, Instant-Start Fluorescent Lamp

This standard data sheet is compatible with IEC 60081.

Lamp description

Lamp abbreviation	40W/48T12/SP
Nominal wattage	40 watts
Nominal overall length	48 in (1200mm)
Bulb designation	T12 (T38)
Base	Fa8, single pin
Circuit application	Instant start

Dimensional characteristics (definitions of Part II apply)

	Inches		Millimeters	
	Min	Max	Min	Max
A (Base face to base face)	45.10	45.30	1143.0	1150.6
B (Base face to end of opposite base pin)	45.42	45.65	1153.7	1159.5
C (End of base pin to end of opposite pin end)	45.74	46.00	1161.8	1168.4
D (Bulb outside diameter)	1.41	1.59	35.8	40.4

Electrical characteristics

Lamp operating characteristics (conditions of clause 11 apply)

Wattage (W)	39
Voltage (V)	100
Current (A)	0.425

Reference ballast characteristics

Rated input voltage (V)	430
Reference current (A)	0.425
Impedance (ohms)	930

Information for ballast design (conditions of clause 12 apply)

Lamp starting requirements

Voltage	
at 50°F (10°C) and above, (Vrms) min	385

7881-ANSI-3004-1

© 2014 National Electrical Manufacturers Association

57-Watt, 72-Inch T12, Single Pin, Instant-Start Fluorescent Lamp

This standard data sheet is compatible with IEC 60081.

Lamp description

Lamp abbreviation	57W/72T12/SP
Nominal wattage	57 watts
Nominal overall length	72 in (1800mm)
Bulb designation	T12 (T38)
Base	Fa8, single pin
Circuit application	Instant start

Dimensional characteristics (definitions of Part II apply)

	Inches		Millimeters	
	Min	Max	Min	Max
A (Base face to base face)	69.10	69.30	1755.1	1760.2
B (Base face to end of opposite base pin)	69.42	69.65	1763.2	1769.1
C (End of base pin to end of opposite pin end)	69.74	70.00	1771.4	1778.0
D (Bulb outside diameter)	1.41	1.59	35.8	40.4

Electrical characteristics

Lamp operating characteristics (conditions of clause 11 apply)

Wattage (W)	57
Voltage (V)	149
Current (A)	0.425

Reference ballast characteristics

Rated input voltage (V)	525
Reference current (A)	0.425
Impedance (ohms)	1100

Information for ballast design (conditions of clause 12 apply)

Lamp starting requirements

Voltage	
at 50°F (10°C) and above, (V _{rms}) min	475

7881-ANSI-3005-1

© 2014 National Electrical Manufacturers Association

60-Watt, 96-Inch T12, Single Pin, Instant-Start Fluorescent Lamp

Lamp description

Lamp abbreviation	60W/96T12/SP
Nominal wattage	60 watts
Nominal overall length	96 in (2400mm)
Bulb designation	T12 (T38)
Base	Fa8, single pin
Circuit application	Instant start

Dimensional characteristics (definitions of Part II apply)

	Inches		Millimeters	
	Min	Max	Min	Max
A (Base face to base face)	93.10	93.30	2364.7	2369.8
B (Base face to end of opposite base pin)	93.42	93.65	2372.9	2378.7
C (End of base pin to end of opposite pin end)	93.74	94.00	2381.0	2387.6
D (Bulb outside diameter)	1.41	1.59	35.8	40.4

Electrical characteristics

Lamp operating characteristics (conditions of clause 11 apply)

Wattage (W)	60.5
Voltage (V)	157
Current (A)	0.440

Reference ballast characteristics

Rated input voltage (V)	625
Reference current (A)	0.425
Impedance (ohms)	1280

Information for ballast design (conditions of clause 12 apply)

Lamp starting requirements

Voltage	
at 50°F (10°C) and above, (Vrms) min	565
Lamp current crest factor	2.00 max

7881-ANSI-3006-1

© 2014 National Electrical Manufacturers Association

75-Watt, 96-Inch T12, Single Pin, Instant-Start Fluorescent Lamp

This standard data sheet is compatible with IEC 60081.

Lamp description

Lamp abbreviation	75W/96T12/SP
Nominal wattage	75 watts
Nominal overall length	96 in (2400mm)
Bulb designation	T12 (T38)
Base	Fa8, single pin
Circuit application	Instant start

Dimensional characteristics (definitions of Part II apply)

	Inches		Millimeters	
	Min	Max	Min	Max
A (Base face to base face)	93.10	93.30	2364.7	2369.8
B (Base face to end of opposite base pin)	93.42	93.65	2372.9	2378.7
C (End of base pin to end of opposite pin end)	93.74	94.00	2381.0	2387.6
D (Bulb outside diameter)	1.41	1.59	35.8	40.4

Electrical characteristics

Lamp operating characteristics (conditions of clause 11 apply)

Wattage (W)	75
Voltage (V)	197
Current (A)	0.425

Reference ballast characteristics

Rated input voltage (V)	625
Reference current (A)	0.425
Impedance (ohms)	1280

Information for ballast design (conditions of clause 12 apply)

Lamp starting requirements

Voltage	
at 50°F (10°C) and above, (Vrms) min	565

7881-ANSI-3007-1

© 2014 National Electrical Manufacturers Association

25-Watt, 42-Inch T6, Single Pin, Instant-Start Fluorescent Lamp

Lamp description

Lamp abbreviation	25W/42T6/SP
Nominal wattage	25 watts
Nominal overall length	42 in (1050mm)
Bulb designation	T6 (T19)
Base	Fa8, single pin
Circuit application	Instant start

Dimensional characteristics (definitions of Part II apply)

	<u>Inches</u>		<u>Millimeters</u>	
	<u>Min</u>	<u>Max</u>	<u>Min</u>	<u>Max</u>
A (Base face to base face)	39.10	39.30	993.1	998.2
B (Base face to end of opposite base pin)	39.42	39.65	1001.3	1007.1
C (End of base pin to end of opposite pin end)	39.74	40.00	1009.4	1016.0
D (Bulb outside diameter)	0.69	0.81	17.5	20.6

Electrical characteristics

Lamp operating characteristics (conditions of clause 11 apply)

	<u>@.120 A</u>	<u>@.200 A</u>	<u>@.300 A</u>
Wattage (W)	17.8	25.5	32.5
Voltage (V)	174	150	133
Current (A)	0.120	0.200	0.300

Reference ballast characteristics

Rated input voltage (V)	450	450	450
Reference current (A)	0.120	0.200	0.300
Impedance (ohms)	3200	1960	1350

Information for ballast design (conditions of clause 12 apply)

Lamp starting requirements

Voltage	
at 50°F (10°C) and above, (Vrms) min	405

7881-ANSI-3008-1

© 2014 National Electrical Manufacturers Association

38-Watt, 64-Inch T6, Single Pin, Instant-Start Fluorescent Lamp

Lamp description

Lamp abbreviation	38W/64T6/SP
Nominal wattage	38 watts
Nominal overall length	64 in (1600mm)
Bulb designation	T6 (T19)
Base	Fa8, single pin
Circuit application	Instant start

Dimensional characteristics (definitions of Part II apply)

	<u>Inches</u>		<u>Millimeters</u>	
	<u>Min</u>	<u>Max</u>	<u>Min</u>	<u>Max</u>
A (Base face to base face)	61.10	61.30	1551.9	1557.0
B (Base face to end of opposite base pin)	61.42	61.65	1560.1	1565.9
C (End of base pin to end of opposite pin end)	61.74	62.00	1568.2	1574.8
D (Bulb outside diameter)	0.69	0.81	17.5	20.6

Electrical characteristics

Lamp operating characteristics (conditions of clause 11 apply)

	<u>@.120 A</u>	<u>@.200 A</u>	<u>@.300 A</u>
Wattage (W)	26.8	38.5	50.0
Voltage (V)	267	233	201
Current (A)	0.120	0.200	0.300

Reference ballast characteristics

Rated input voltage (V)	600	600	600
Reference current (A)	0.120	0.200	0.300
Impedance (ohms)	4180	2560	1740

Information for ballast design (conditions of clause 12 apply)

Lamp starting requirements

Voltage	
at 50°F (10°C) and above, (Vrms) min	540

7881-ANSI-3009-1

© 2014 National Electrical Manufacturers Association

38-Watt, 72-Inch T8, Single Pin, Instant-Start Fluorescent Lamp

Lamp description

Lamp abbreviation	38W/72T8/SP
Nominal wattage	38 watts
Nominal overall length	72 in (1800mm)
Bulb designation	T8 (T25)
Base	Fa8, single pin
Circuit application	Instant start

Dimensional characteristics (definitions of Part II apply)

	<u>Inches</u>		<u>Millimeters</u>	
	<u>Min</u>	<u>Max</u>	<u>Min</u>	<u>Max</u>
A (Base face to base face)	69.10	69.30	1755.1	1760.2
B (Base face to end of opposite base pin)	69.42	69.65	1763.7	1769.1
C (End of base pin to end of opposite pin end)	69.74	70.00	1771.4	1778.0
D (Bulb outside diameter)	0.94	1.10	24.0	27.8

Electrical characteristics

Lamp operating characteristics (conditions of clause 11 apply)

	<u>@.120 A</u>	<u>@.200A</u>	<u>@.300 A</u>
Wattage (W)	25.0	38.0	50.0
Voltage (V)	245	220	195
Current (A)	0.120	0.200	0.300

Reference ballast characteristics

Rated input voltage (V)	600	600	600
Reference current (A)	0.120	0.200	0.300
Impedance (ohms)	4180	2560	1740

Information for ballast design (conditions of clause 12 apply)

Lamp starting requirements

Voltage	
at 50°F (10°C) and above, (Vrms) min	540

7881-ANSI-3010-1

© 2014 National Electrical Manufacturers Association

51-Watt, 96-Inch T8, Single Pin, Instant-Start Fluorescent Lamp

Lamp description

Lamp abbreviation	51W/96T8/SP
Nominal wattage	51 watts
Nominal overall length	96 in (2400mm)
Bulb designation	T8 (T25)
Base	Fa8, single pin
Circuit application	Instant start

Dimensional characteristics (definitions of Part II apply)

	<u>Inches</u>		<u>Millimeters</u>	
	<u>Min</u>	<u>Max</u>	<u>Min</u>	<u>Max</u>
A (Base face to base face)	93.10	93.30	2364.7	2369.8
B (Base face to end of opposite base pin)	93.42	93.65	2372.9	2378.7
C (End of base pin to end of opposite pin end)	93.74	94.00	2381.0	2387.6
D (Bulb outside diameter)	0.94	1.10	24.0	27.8

Electrical characteristics

Lamp operating characteristics (conditions of clause 11 apply)

	<u>@.120A</u>	<u>@.200A</u>	<u>@.300A</u>
Wattage (W)	33.5	51.0	67.0
Voltage (V)	325	295	263
Current (A)	0.120	0.200	0.300

Reference ballast characteristics

Rated input voltage (V)	750	750	750
Reference current (A)	0.120	0.200	0.300
Impedance (ohms)	5100	3150	2150

Information for ballast design (conditions of clause 12 apply)

Lamp starting requirements

Voltage	
at 50°F (10°C) and above, (V _{rms}) min	675

7881-ANSI-3011-1

© 2014 National Electrical Manufacturers Association

25-Millimeter, 45-Inch, Cold-Cathode Fluorescent Lamp

Lamp description

Lamp abbreviation	45T8/CAP/CC
Nominal overall length	45 in (1125mm)
Bulb	25mm (1.00 in)
Base type	Cap
Diameter of cap	0.69 in (17.5mm)

Dimensional characteristics

	<u>Inches</u>		<u>Millimeters</u>	
	<u>Min</u>	<u>Max</u>	<u>Min</u>	<u>Max</u>
Lamp length from ends of opposite base caps	44.88	45.13	1140.0	1146.3
Bulb diameter	0.95	1.04	24.1	26.4
Length of cap	0.94	1.00	23.9	25.4

Electrical characteristics

Lamp operating characteristics

	<u>Low</u>	<u>High</u>
	<u>pressure</u>	<u>pressure</u>
Wattage (W)	26	28
Voltage (V)	250	270
Current (A)	0.120	0.120

The preceding lamp operating characteristics are based on operation in a cold-cathode type circuit at an ambient temperature of 25°C (77°F) with a 60 Hz sinusoidal power supply.

Information for ballast design

Lamp starting requirements

Voltage (see note) 450 V

NOTE—Ballast open circuit voltage at rated line voltage.

7881-ANSI-3012-1

© 2014 National Electrical Manufacturers Association

25-Millimeter, 69-Inch, Cold-Cathode Fluorescent Lamp

Lamp description

Lamp abbreviation	69T8/CAP/CC
Nominal overall length	69 in (1725mm)
Bulb	25mm (1.00 in)
Base type	Cap
Diameter of cap	0.69 in (17.5mm)

Dimensional characteristics

	<u>Inches</u>		<u>Millimeters</u>	
	<u>Min</u>	<u>Max</u>	<u>Min</u>	<u>Max</u>
Lamp length from ends of opposite base caps	68.88	69.13	1749.6	1755.9
Bulb diameter	0.95	1.04	24.1	26.4
Length of cap	0.94	1.00	23.9	25.4

Electrical characteristics

Lamp operating characteristics

	<u>Low</u>	<u>High</u>
	<u>pressure</u>	<u>pressure</u>
Wattage (W)	34	37
Voltage (V)	330	350
Current (A)	0.120	0.120

The preceding lamp operating characteristics are based on operation in a cold-cathode type circuit at an ambient temperature of 25°C (77°F) with a 60 Hz sinusoidal power supply.

Information for ballast design

Lamp starting requirements

Voltage (see note)	600 V	750 V
--------------------	-------	-------

NOTE—Ballast open circuit voltage at rated line voltage.

7881-ANSI-3013-1

© 2014 National Electrical Manufacturers Association

25-Millimeter, 93-Inch, Cold-Cathode Fluorescent Lamp

Lamp description

Lamp abbreviation	93T8/CAP/CC
Nominal overall length	93 in (2325mm)
Bulb	25mm (1.00 in)
Base type	Cap
Diameter of cap	0.69 in (17.5mm)

Dimensional characteristics

	<u>Inches</u>		<u>Millimeters</u>	
	<u>Min</u>	<u>Max</u>	<u>Min</u>	<u>Max</u>
Lamp length from ends of opposite base caps	92.88	93.13	2359.2	2365.5
Bulb diameter	0.95	1.04	24.1	26.4
Length of cap	0.94	1.00	23.9	25.4

Electrical characteristics

Lamp operating characteristics

	<u>Low</u>	<u>High</u>
	<u>pressure</u>	<u>pressure</u>
Wattage (W)	42	46
Voltage (V)	420	450
Current (A)	0.120	0.120

The preceding lamp operating characteristics are based on operation in a cold-cathode type circuit at an ambient temperature of 25°C (77°F) with a 60 Hz sinusoidal power supply.

Information for ballast design

Lamp starting requirements

Voltage (see note)	750 V	835 V
--------------------	-------	-------

NOTE—Ballast open circuit voltage at rated line voltage.

7881-ANSI-3014-1

© 2014 National Electrical Manufacturers Association

54-Watt, 96-Inch T8 Single Pin Instant-Start Fluorescent Lamp

Lamp Description

Lamp abbreviation	54W/96T8/IS
Nominal wattage	54 watts
HF reference wattage	51 watts
Nominal overall length	96 in (2400mm)
Bulb designation	T8 (T25)
Base	Fa8, Single Pin
Circuit application	Instant start

NOTE—This lamp is an energy-saver version of the former 59W/96T8/HF/IS lamp. It was introduced commercially as a 54W lamp, which represents the measured wattage on a 60 Hz reference ballast for 59W/96T8/HF/IS fluorescent lamps. The high frequency (HF) reference wattage of 51W above reflects the measured wattage when operated on the HF reference ballast.

Dimensional characteristics (definitions of Part II apply)

	<u>Inches</u>		<u>Millimeters</u>	
	<u>Min</u>	<u>Max</u>	<u>Min</u>	<u>Max</u>
A (Base face to base face)	93.10	93.30	2364.7	2369.8
B (Base face to end of opposite base pin)	93.42	93.65	2372.9	2378.7
C (End of base pin to end of opposite pin end)	93.73	94.00	2381.0	2387.8
D (Bulb, outside diameter)	0.94	1.10	23.9	27.9

Electrical Characteristics (with a 25 kHz reference ballast)

Typical lamp electrical characteristics will be as follows when the lamp is operated at 25 kHz with a resistive ballast. This represents a reference ballast circuit for HF operation. The following characteristics set the “rated wattage” for this lamp type. The HF reference ballast is specified to provide approximately the same lamp light output as when it is operated on a 60 Hz measurement ballast for 59W/96T8/HF/IS fluorescent lamps.

7881-ANSI-3015-1

© 2014 National Electrical Manufacturers Association

**54-Watt, 96-Inch T8 Single Pin
Instant-Start Fluorescent Lamp
Page 2 of 3**

Typical lamp operating characteristics (conditions of clause 11 apply)

Wattage (W)	51.4
Voltage (V)	234

Reference ballast characteristics

Typical input voltage (V)	573
Current (A)	0.224
Impedance (ohms)	1500
Frequency (kHz)	25

NOTE—The reference ballast characteristics are normative, and lamp current should be set to the indicated value during photometric and electrical measurements per the ANSLG C82.2, C82.3 and C78.375 standards. No cathode heat is applied for the HF reference measurements. The lamp operating characteristics are typical of average lamp performance on the reference ballast.

www.Lisungroup.com

7881-ANSI-3015-1

© 2014 National Electrical Manufacturers Association

Information for HF ballast design (conditions of clause 12 apply)

Lamp current limits

Minimum design lamp current without cathode heat, I_{rms} (A)	0.155
Maximum design lamp current, I_{rms} (A)	0.320
Maximum lamp current crest factor	1.7

NOTE—Ballasts designed for lamps without cathode heating shall have a design minimum lamp current around 0.155 A. Variation around this design value due to potential tolerances related to components and manufacturing is expected. However, the lamp current shall not be less than 0.140 A under any condition without cathode heating. Further, the lamp current shall not exceed 0.335 A under any operating condition.

Lamp starting requirements

For lamp use on HF instant-start electronic ballasts. The requirements shall be met at any primary voltage between 90% and 110% of ballast's rated input voltage.

Instant starting requirements

Open circuit voltage (min), V_{rms} , $T_{amb} > 50^{\circ}F$	725
Maximum starting time (ms)	100

www.Lisungroup.com

7881-ANSI-3015-1

© 2014 National Electrical Manufacturers Association