



Product Categories

- [Goniophotometer >](#)
- [Spectroradiometer >](#)
- [Integrating Sphere >](#)
- [LED Test Instruments >](#)
- [CFL Testing Instruments >](#)
- [Photometer and Colorimeter >](#)
- [EMI and EMC Test Systems >](#)
- [Electronic Ballast Tester >](#)
- [Electrical Safety Tester >](#)
- [Environmental Test Chamber >](#)
- [Plug and Switch Testing >](#)
- [AC and DC Power Supply >](#)
- [Object Color and Glossiness Test >](#)
- [Mask Produce and Test Machine >](#)
- [Electronic Components Test >](#)



Ring Wave Generator

Product No: RWG61000-12

Get a Quote

Your email address will not be published. Required fields are marked \*

<input type="text" value="Name*"/>	<input type="text" value="Company*"/>
<input type="text" value="Email*"/>	<input type="text" value="Cell/WhatsApp"/>
<input type="text" value="Message*"/>	
<input type="text" value="Verify Code"/>	 <input type="button" value="Send"/>

Description

Download

Related Technical Articles

[Surge Generators for DC HiPot and Surge Tests](#)

[Introduction of Conducted Immunity Testing](#)



in both English and Chinese.

### Specification:

Product Model	RWG61000-12	RWG61000-12T	RWG61000-12A	RWG61000-12AT
Output Voltage	0~4KV		0~6KV	
Voltage/Current Wave	Open circuit voltage wave: frontier: $0.5\mu\text{s}\pm 20\%$ . Short circuit current wave: frontier: $\leq 1\mu\text{s}$ . Oscillation frequency: $100\text{kHz}\pm 10\%$			
Polarity	Positive, Negative or Positive/Negative automatic			
Phase Shift	Asynchronous, Synchronization $0^\circ\sim 360^\circ$ or Specific Angle			
Output Impedance	$12\Omega$ , $30\Omega$			
Coupling/Decoupling Network (CDN)	Includes a 16A single phase	Includes a 20A 3phases/5wires	Includes a 16A single phase	Includes a 20A 3phases/5wires
Working Power	AC220V (Option 110V) $\pm 10\%$ , 50/60Hz			
Dimension (DxWxH)	44x45x35cm	44x45x20cm 44x45x35cm (CDN)	44x45x30cm 44x45x20cm (CDN)	44x45x30cm 44x45x35cm (CDN)
Gross Weight	About 28kg	About 46kg	About 45kg	About 48kg

### Super big LCD touch screen and built-in Windows CE

### Waveform:

Tags : [Ring Wave Generator](#) , [RWG61000-12](#)

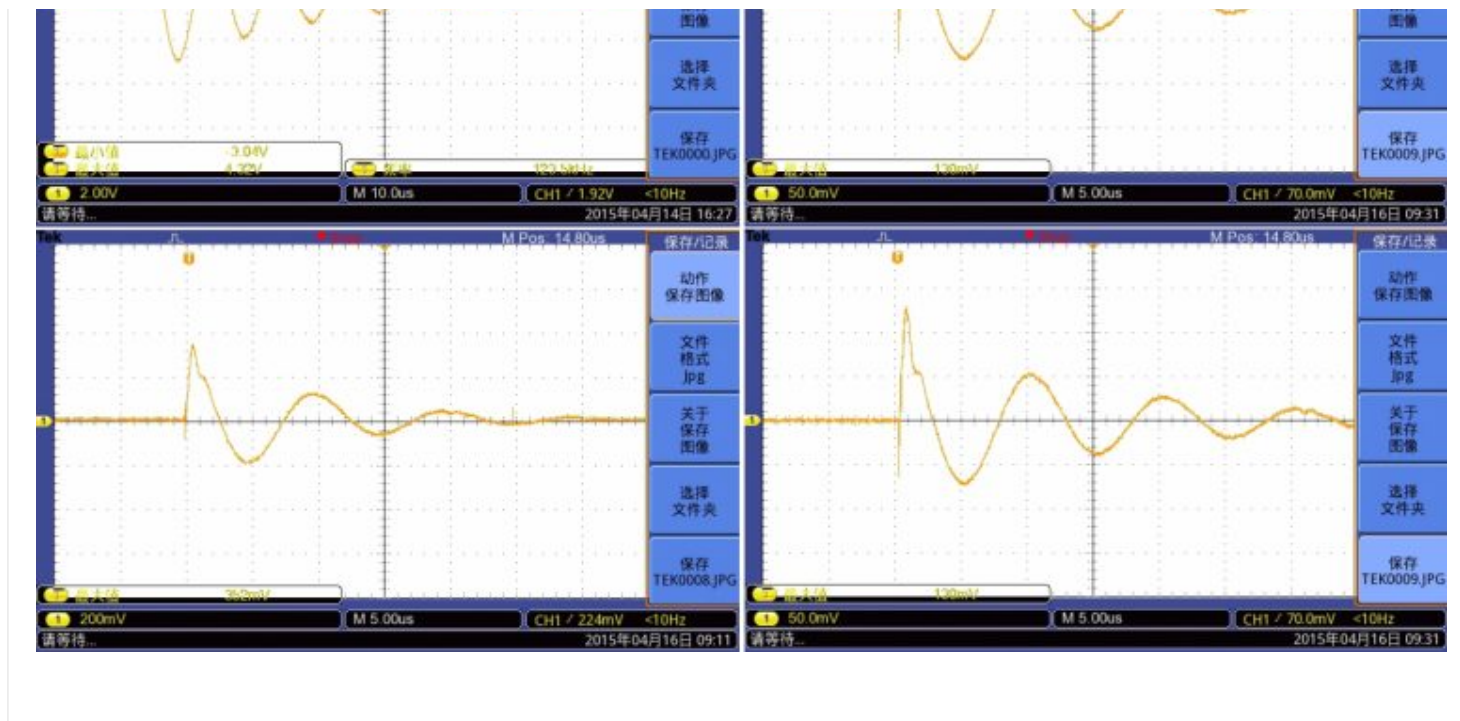



Home > Products > Surge Generator

Product Categories

- Goniophotometer >
- Spectroradiometer >
- Integrating Sphere >
- LED Test Instruments >
- CFL Testing Instruments >
- Photometer and Colorimeter >
- EMI and EMC Test Systems >
- Electronic Ballast Tester >
- Electrical Safety Tester >
- Environmental Test Chamber >
- Plug and Switch Testing >
- AC and DC Power Supply >
- Object Color and Glossiness Test >
- Mask Produce and Test Machine >
- Electronic Components Test >



Surge Generator

Product No: SG61000-5

Get a Quote

Your email address will not be published. Required fields are marked \*

Name\* Company\*

Email\* Cell/WhatsApp

Message\*

Verify Code  Send X

LISUN is the Leader in Lighting and Electrical Test Instruments. Our senior engineers are online, welcome to talk with us!

Customer Support just now

- Description
- Video
- Download

The SG61000-5 fully automatic surge generator (also called lightning surge immunity test, combination wave generator, surge current generator/surge voltage generator, combined surge voltage and current generator) .

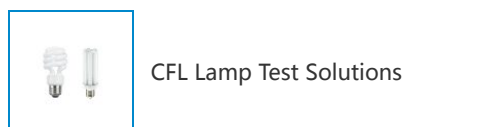
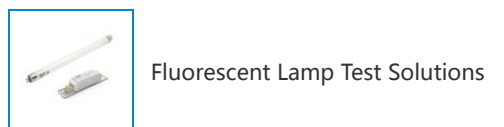
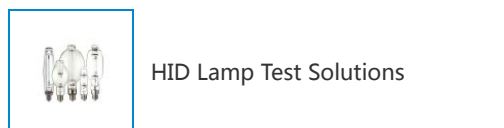
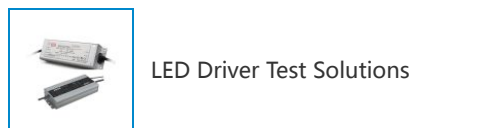
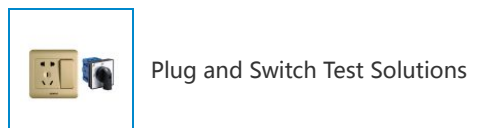
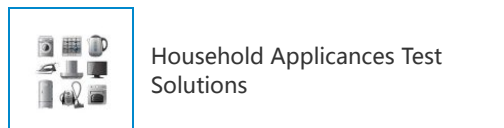
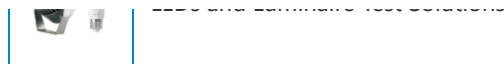

Product Model	SG61000-5SA	SG61000-5SB	SG61000-5	SG61000-5H-SP	SG61000-5T
Output Voltage (Open)	1.2/50μs±20%	1.2/50μs±20%	1.2/50μs±20%	1.2/50μs±20%	1.2/50μs±20%
Output Current (Short)	8/20μs±20%	8/20μs±20%	8/20μs±20%	8/20μs±20%	8/20μs±20%
Output Impedance	2Ω and 12Ω	2Ω and 12Ω	2Ω and 12Ω	2Ω 12Ω and 500Ω	2Ω and 12Ω
Output Voltage Range	0~4.8KV±10%	0~4.8KV±10%	0~6KV±10%	0~10KV±10%	0~6KV±10%
Output Current Range	0~2.4KA±10%	0~2.4KA±10%	0~3KA±10%	0~5KA±10%	0~3KA±10%
Surge Repetition	1~9999 times	1~9999 times	1~9999 times	1~9999 times	1~9999 times
Interval Time	20~9999s	20~9999s	20~9999s	30~9999s	20~9999s
Polarity	Positive, Negative or Positive/Negative automatic				
Phase Shift	Asynchronous, Synchronization 0°~ 360° or Specific Angle				
Special Function	N/A		Built-in High voltage and current 2000:1 attenuator probe (Less than 10KV s generator is 1000:1), connect with LISUN <a href="#">OSP1102</a> directly		
Operation Way	Button Input		Touch screen with super big		
Dimensions (WxDxH)	44x45x35cm	44x45x35cm	44x45x35cm	56x69x1	
Gross Weight	About 30kg	About 30kg	About 30kg	About 2	
Coupling/Decoupling Network (CDN)	Includes a 16A single phase CDN				Includes a 20A 3phases CDN
Isolation Transformer for EUT (Optional)	LISUN <a href="#">ITEU-SP4K</a> (220V Single phase) or <a href="#">ITUS-SP2K</a> (110V)				LISUN <a href="#">ITEU-TP10K</a> or <a href="#">ITUS-</a>

LISUN is the Leader in Lighting and Electrical Test Instruments. Our senior engineers are online, welcome to talk with us!

Customer Support just now



IEC International Electrotechnical Commission



ISO International Organization for Standardization



BIS Bureau of Indian Standards



ANSI American National Standards Institute



SASO Saudi Arabian Standards Organization



TSE Turkish Standards Institution



NOM Norma Oficial Mexicana



GB China Guo Biao



Protect Device for Surge Test PD-E01

We suggest you choose LISUN SG-DESK Surge Generator desk to work with SG61000-5H Surge Generator and SG61000-5H Transformer.

Tags : [SG61000-5](#) , [SG61000-5H](#) , [Surge Generator](#)

LISUN is the Leader in Lighting and Electrical Test Instruments. Our senior engineers are online, welcome to talk with us!



Customer Support

just now



Related Technical Articles

Surge Generators For Telecom And IEC-61000-4-5 Testing

Led test instruments supplier in China

Lighting surge analysis and how does it work

Surge Generators for DC HiPot and Surge Tests

LISUN SG61000-5 Surge Generator – After Sales Questions and Answers

Surge test and impulse withstand voltage test work principle introduce and both test difference

Surge Generators for DC HiPot and Surge Tests

Why are Surge Generators Important

How do surge generators perform surge immunity tests

How does the surge generator avoid power surges

Related Successful Case

India-The customer successfully installed and operated the LPCE-3 compact



SG-DESK Surge Generator Desk

What is a combination wave?

A Combination Wave Generator (CWG) sends a voltage impulse into an open circuit while also delivering a current impulse into a short circuit to mimic both of these situations. The SG61000-5 Surge Generator's combination wave is 1.2/50us and 8/20us as below:

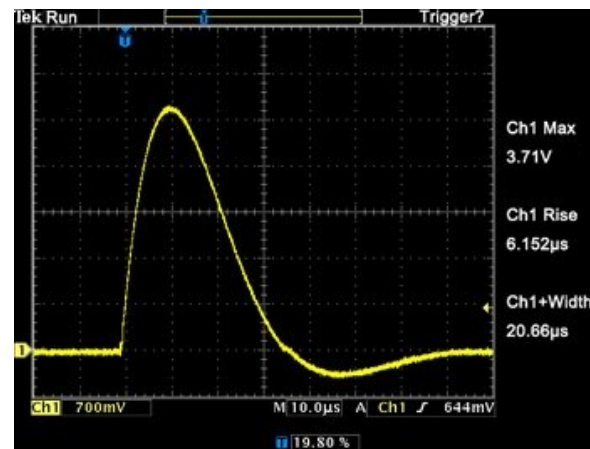

6KV Short Circuit Current Output Waveform (780:1)



6KV Open Circuit Voltage Output Waveform (1000:1)

LISUN is the Leader in Lighting and Electrical Test Instruments. Our senior engineers are online, welcome to talk with us! Customer Support just now



Recognized as an  
American National Standard

**IEEE**  
**C62.41-1991**  
(Revision of  
IEEE C62.41-1980)

# IEEE Recommended Practice on Surge Voltages in Low-Voltage AC Power Circuits

Sponsor  
**Surge-Protective Devices Committee**  
of the  
**IEEE Power Engineering Society**

Approved February 25, 1991

**IEEE Standards Board**

Approved September 6, 1991

**American National Standards Institute**

**Abstract:** A practical basis is provided for the selection of voltage and current tests to be applied in evaluating the surge withstand capability of equipment connected to utility power circuits, primarily in residential, commercial, and light industrial applications. The recommended practice covers the origin of surge voltages, rate of occurrence and voltage levels in unprotected circuits, waveshapes of representative surge voltages, energy, and source and impedance. Three locations categories are defined according to their relative position from the building service entrance. For each category, representative waveforms of surge voltages and surge currents are described, organized in two recommended "standard waveforms" and three suggested "additional waveforms."

**Keywords:** ac power circuits, current tests, surge monitoring, surge test waveforms, surge voltages, surges, test waveforms, voltage tests, wave shape

The Institute of Electrical and Electronics Engineers, Inc.  
345 East 47th Street, New York, NY 10017-2394, USA

Copyright © 1991 by  
The Institute of Electrical and Electronics Engineers, Inc.  
All rights reserved. Published 1991  
Printed in the United States of America

ISBN 1-55937-130-7

*No part of this publication may be reproduced in any form,  
in an electronic retrieval system or otherwise,  
without the prior written permission of the publisher.*



**Library of Congress Cataloging-in-Publication Data**

Institute of Electrical and Electronics Engineers.

IEEE recommended practice on surge voltages in low-voltage AC power circuits / sponsor, Surge Protective Devices Committee of the IEEE Power Engineering Society.

p. cm.

At head of title: IEEE C62.41-1991 (revision of IEEE C62.41-1980).

“Approved February 25, 1991, IEEE Standards Board.”

Includes bibliographical references.

ISBN 1-55937-130-7

1. Transients (Electricity) 2. Electric circuits—Alternating current. 3. Electric power systems—Protection. I. IEEE Power Engineering Society. Surge Protective Devices Committee.

II. Title.

TK3226.I57 1991

621.31'7—dc20

91-19748  
CIP

**IEEE Standards** documents are developed within the Technical Committees of the IEEE Societies and the Standards Coordinating Committees of the IEEE Standards Board. Members of the committees serve voluntarily and without compensation. They are not necessarily members of the Institute. The standards developed within IEEE represent a consensus of the broad expertise on the subject within the Institute as well as those activities outside of IEEE that have expressed an interest in participating in the development of the standard.

Use of an IEEE Standard is wholly voluntary. The existence of an IEEE Standard does not imply that there are no other ways to produce, test, measure, purchase, market, or provide other goods and services related to the scope of the IEEE Standard. Furthermore, the viewpoint expressed at the time a standard is approved and issued is subject to change brought about through developments in the state of the art and comments received from users of the standard. Every IEEE Standard is subjected to review at least every five years for revision or reaffirmation. When a document is more than five years old and has not been reaffirmed, it is reasonable to conclude that its contents, although still of some value, do not wholly reflect the present state of the art. Users are cautioned to check to determine that they have the latest edition of any IEEE Standard.

Comments for revision of IEEE Standards are welcome from any interested party, regardless of membership affiliation with IEEE. Suggestions for changes in documents should be in the form of a proposed change of text, together with appropriate supporting comments.

Interpretations: Occasionally questions may arise regarding the meaning of portions of standards as they relate to specific applications. When the need for interpretations is brought to the attention of IEEE, the Institute will initiate action to prepare appropriate responses. Since IEEE Standards represent a consensus of all concerned interests, it is important to ensure that any interpretation has also received the concurrence of a balance of interests. For this reason IEEE and the members of its technical committees are not able to provide an instant response to interpretation requests except in those cases where the matter has previously received formal consideration.

Comments on standards and requests for interpretations should be addressed to:

Secretary, IEEE Standards Board  
445 Hoes Lane  
P.O. Box 1331  
Piscataway, NJ 08855-1331  
USA

IEEE Standards documents are adopted by the Institute of Electrical and Electronics Engineers without regard to whether their adoption may involve patents on articles, materials, or processes. Such adoption does not assume any liability to any patent owner, nor does it assume any obligation whatever to parties adopting the standards documents.

## Foreword

(This Foreword is not a part of IEEE C62.41-1991, IEEE Recommended Practice on Surge Voltages in Low-Voltage AC Power Circuits.)

Transient surge voltages occurring in ac power circuits can be the cause of operational upset or product failure in industrial and residential systems and equipment. These problems have received increased attention in recent years because of the widespread application of complex semiconductor devices that are more sensitive to voltage surges than vacuum tubes, relays, and earlier generations of semiconductor devices.

Logical and economical design of circuits to protect vulnerable electronic systems from upset or failure requires knowledge of or an estimate of:

- (1) Transient voltage and current waveforms,
- (2) Frequency of occurrence of transients with various energy levels,
- (3) Particular environmental variations such as amplitudes, and
- (4) Upset or failure threshold of the particular equipment to be protected.

The previous edition of this document, IEEE C62.41-1980, "IEEE Guide for Surge Voltages in Low-Voltage AC Power Circuits" (also known as IEEE Std 587-1980), contained similar information about the surge environment. Most of the voltage surge recordings for the 1980 edition were made prior to 1975, when electronic instrumentation for surge monitoring was not readily available. Instrumentation and data-base information, while still limited in some parameters such as very short rise time and frequencies, have vastly improved, as reflected in this edition.

This document provides updated and expanded information relevant to a typical surge environment based upon location within the building, power-line impedance to the surge, and total wire length. Other parameters often adding to the surge environment include proximity and type of other electrical loads, type of electrical service, wiring quality, and geographic location.

New information on probability of surges has been added. A new waveform incorporating a shorter front and two new waveforms incorporating longer durations supplement the two standard waveforms. A new section consisting of a "how-to-use" guide has also been added to allow the reader to develop a rational approach to equipment protection by following the recommendations of this document.

It must be noted that a recommendation of test waveforms alone is not an equipment performance specification. Other documents based on the waveforms recommended herein have been or will be developed to describe the performance of equipment or protective devices in low-voltage ac power circuits.

Some manufacturers have advertised that their protective device "meets the requirements" of IEEE Std 587-1980 or IEEE C62.41-1980. Such a statement is a misuse of the document, since the document only describes surges and does not specify any specific safe level or performance of equipment during application of a test waveform. The levels given in this document reflect typical environment conditions and provide a menu from which equipment designers and users can select the values appropriate to a specific application. Any statement that a protector "meets the requirements of" or "is certified to" this document is inappropriate and misleading.

The Summary given after this Foreword is intended only for a rapid overview and therefore is not included as part of the recommended practice.

Suggestions for improvements of this recommended practice will be welcomed. They should be sent to the Secretary, IEEE Standards Board, Institute of Electrical and Electronics Engineers, 445 Hoes Lane, P.O. Box 1331, Piscataway, NJ 08855-1331, USA.

At the time this recommended practice was completed, the membership of the Working Group on Surge Characterization in Low-Voltage Circuits of the Power Engineering Society consisted of:

**F.D. Martzloff, Chair**

G. J. Bagnall  
D. W. Boehm  
B. J. Braskich  
M. J. Coyle  
J. G. Dalton  
B. Dillon-Malone  
F. P. Drake \*  
B. Epstein \*  
L. Fish

H. E. Foelker  
E. Gallo  
P. Goodwin \*  
R. M. Henry  
C. P. Herig \*  
P. Jedlicka  
J. L. Koepfinger  
C. M. Meier  
K. A. Meindorfer

**R.B. Standler,\* Secretary**

W. Milwitt  
R. Odenberg  
W. T. Rhoades\*  
P. Richman  
L. Shulman  
L. D. Sweeney  
D. P. Symanski  
B. I. Wolff \*  
D. M. Worden

\* Chapter Editor or Task Force Leader

Other individuals who have contributed data\*\* or written comments are:

D. A. Bell  
H. A. Buschke  
C. E. Chamney  
R. A. Combella  
D. R. Covington  
E. P. Dick  
J. I. Herrera  
W. Kapp

W. H. Lewis  
C. E. Luebke  
E. H. Marrow, Jr.  
A. McEachern  
R. C. Mierendorf  
M. Parente  
A. Rebeck  
L. Regez

W. Roehr  
H. Rauworth  
T. Shaughnessy  
P. D. Speranza  
M. F. Stringfellow  
M. X. Tetreault  
P. Van Dick  
L. Williams

\*\* Contributions to the data base from many researchers, as indicated by the source references, are also gratefully acknowledged by the working group.

When the Balloting Committee of the Surge-Protective Devices Committee reviewed and approved this document, it had the following membership:

G. J. Bagnall  
J. G. Dalton  
D. C. Dawson  
C. C. Erven  
M. M. Flack  
H. E. Foelker  
G. L. Gaibrois  
P. A. Goodwin  
C.D. Hansell  
G. S. Haralampu  
J. A. Hetrick

A. R. Hileman  
S. S. Kershaw  
J. L. Koepfinger  
W. A. Maguire  
F. D. Martzloff  
E. H. Marrow, Jr.  
R. Odenberg  
J.C. Osterhout  
M. Parente  
P. Richman  
E. C. Sakshaug

R. M. Simpson III  
R. B. Standler  
K. B. Stump  
L.D. Sweeney  
A. Sweetana  
D.P. Symanski  
E.R. Taylor, Jr.  
R. S. Thallam  
S.G. Whisenant  
L. Williams  
B.I. Wolff

The Accredited Standards Committee on Surge Arresters, C62, that reviewed and approved this document, had the following members when at the time this document was sent to letter ballot:

**Joseph L. Koepfinger, Chair**

**John A. Gauthier, Secretary**

<i>Organization Represented</i>	<i>Name of Representative</i>
Association of American Railroads .....	Wayne Etter
Bonneville Power Administration.....	G. E. Lee
Exchange Carriers Standards Association .....	Michael Parente
Electric Light and Power .....	R. A. Jones H. E. Foelker W. A. Maguire Dale Peters J. W. Wilson M. C. Mingoia (Alt.)

Institute of Electrical and Electronics Engineers .....	J. L. Koepfinger G. L. Gaibrois C. Hansell Dale Hedman W. H. Kapp S. S. Kershaw, Jr. Edgar Taylor
National Electrical Manufacturers Association .....	Scott Law Basil Dillon-Malone Dennis W. Lenk Bernhard Wolff D. Worden David Bell ( <i>Alt.</i> ) Larry Bock ( <i>Alt.</i> )
Rural Electrification Administration .....	George J. Bagnall
Underwriters Laboratories .....	P. Notarian Larry Williams ( <i>Alt.</i> )
Canadian Standards Association .....	D.M. Smith
Members-at-Large .....	Peter Goodwin F. D. Martzloff J. Osterhout B. Panesar

The final conditions for approval of this recommended practice were met on February 25, 1991. This recommended practice was conditionally approved by the IEEE Standards Board on December 6, 1990, with the following membership:

**Marco W. Migliaro, Chair**

**Andrew G. Salem, Secretary**

**James M. Daly, Vice Chair**

Dennis Bodson  
Paul L. Borrill  
Fletcher J. Buckley  
Allen L. Clapp  
Stephen R. Dillon  
Donald C. Fleckenstein  
Jay Forster\*  
Thomas L. Hannan

Kenneth D. Hendrix  
John W. Horch  
Joseph L. Koepfinger\*  
Irving Kolodny  
Michael A. Lawler  
Donald J. Loughry  
John E. May, Jr.

Lawrence V. McCall  
L. Bruce McClung  
Donald T. Michael\*  
Stig Nilsson  
Roy T. Oishi  
Gary S. Robinson  
Terrance R. Whittemore  
Donald W. Zipse

\*Member Emeritus

www.LispGroup.com

## Summary

(This Summary is not a part of IEEE C62.41-1991, IEEE Recommended Practice on Surge Voltages in Low-Voltage AC Power Circuits.)

This document describes the occurrence of surges in low-voltage ac power circuits and provides guidance on the simplification of a complex data base into a limited set of representative surges. This simplification will assist designers of equipment in providing the appropriate degree of withstand capability in their designs, allow users of equipment to specify appropriate levels of withstand requirements, and provide test equipment suppliers and test laboratories with a recommended practice for a limited number of well-defined test waveforms.

Protection from surge voltages in ac power circuits can best be achieved through the application of protective devices matched to the environment and to the operational requirements of the equipment. Environmental conditions can be represented by two selected voltage-current waveforms, described as standard waveforms, with amplitude and available energy dependent upon the pertinent location within the power system or distance from the surge source. Circumstances may be encountered where other waveforms, described as additional waveforms, may be appropriate to represent surges caused by less frequent mechanisms or by the presence of equipment recognized as the cause of longer or shorter disturbances.

### Standard Waveforms

For practical purposes, locations are divided into three categories. Surge characteristics, that is, rates of occurrence, waveforms, source impedances, and amplitudes, are discussed for each category of location and exposure.

(1) Locations

*Category A:* Long branch circuits, receptacles (indoor)

*Category B:* Major feeders, short branch circuits, service panel (indoor)

*Category C:* Outdoor overhead lines, service entrance

(2) Exposure

*Low Exposure:* Systems in geographical areas known for low lightning activity, with little load-switching activity.

*Medium Exposure:* Systems in geographical areas known for medium to high lightning activity, or with significant switching transients, or both.

*High Exposure:* Those rare installations that have greater surge exposure than those defined by Low Exposure and Medium Exposure.

(3) Recommended Values

Recommended values are given for the waveforms, voltage amplitude, and current amplitude of representative surges in line-to-neutral, line-to-line, and neutral-to-ground configurations.

### Additional Waveforms

Special situations have been identified in which additional waveforms may be appropriate; these have been added to the standard waveforms initially defined in the 1980 version of this document. These special situations include the presence of large banks of switched capacitors or the operation of fuses at the end of long cables. These cases warrant consideration of additional waveforms that have the capability of depositing substantial energy in a surge-diverting protective device and causing failure of devices not sized for that occurrence. However, the characteristics of these phenomena are closely related to the specifics of the situation, so that it is difficult to provide

generally applicable recommendations. For that reason, this document presents information on these surges as a range of values rather than specific numbers.

The presence of nearby equipment involving load switching can couple bursts of fast transients that have the capability of interfering with logic circuits and causing upsets. This situation has been recognized, and test procedures have been defined by other organizations to demonstrate immunity of equipment that may be subjected to these bursts. This document endorses the recommendations made by these organizations and includes the fast-transient burst where applicable.

### **Guidance Versus Specification**

The recommendations given in this document are provided as the basis for selecting specifications appropriate to the needs of equipment designers and users, depending on the particulars of the situation. While recognizing the desirability of sweeping general specifications, this document cautions the reader against such practice. The specification of equipment withstand capability, and of test levels to prove this capability, remains the responsibility of equipment suppliers and equipment users, based on an understanding of the situation that this document is attempting to provide. While short-term monitoring of an individual site often gives some useful information, the environment is so dynamic that the analysis of a brief period may not give a good prediction of the future environment.

Readers are also warned on the economic fallacy of specifying unrealistic complexities of test procedures or excessive withstand capability in an attempt to obtain greater reliability. The complexity of the surge environment is such that no set of test waveforms will ever completely simulate the environment, and a slightly higher level of surges can always be proposed to boost equipment withstand. This document was prepared with the intent to avoid such unrealistic requirements.

[www.Lisungroup.com](http://www.Lisungroup.com)



## Contents

SECTION	PAGE
1. Scope.....	17
2. How to Use This Document.....	17
2.1 General.....	17
2.2 Achieving Practical Surge Immunity.....	17
2.2.1 Protection Desired .....	18
2.2.2 Equipment Sensitivities.....	18
2.2.3 Power Environment—Surges.....	18
2.2.4 Power Environment —Electrical System.....	18
2.2.5 Performance of Surge-Protective Devices .....	18
2.2.6 Test Environment .....	18
2.2.7 Costs .....	20
2.3 Document Outline .....	20
3. Definitions.....	20
4. References.....	21
5. The Origins of Surge Voltages .....	22
5.1 General.....	22
5.2 Lightning.....	22
5.3 Switching Transients.....	22
6. Summary of Data Base .....	23
6.1 General.....	23
6.2 Notations and Definitions.....	23
6.3 Site Surveys of Power Quality .....	24
6.4 Field Experience .....	24
6.5 Summary of Surge Characteristics.....	25
6.5.1 Peak Amplitude Versus Rate of Occurrence .....	25
6.5.2 Duration.....	26
6.5.3 Ringing Frequency.....	26
6.5.4 Voltage Rate of Change.....	26
6.5.5 Energy Delivery Capability .....	27
6.5.6 Effects of Location, Loads, and Mode of Coupling.....	28
7. Recommended Selection of Representative Surges .....	28
7.1 General.....	28
7.2 Simplification of the Data Base.....	29
7.3 Rate of Occurrence and Voltage Levels in Unprotected Circuits.....	29
7.3.1 General.....	29
7.3.2 Rate of Occurrence Versus Voltage Level.....	30
7.3.3 Exposure Levels.....	30
7.4 Recommended Waveforms.....	32
7.4.1 General.....	32
7.4.2 Ring Wave.....	32
7.4.3 High-Energy Surges.....	35
7.4.4 Fast Transients.....	36
7.5 Amplitude, Energy, and Source Impedance .....	37
7.6 Rate of Voltage Change.....	38

SECTION	PAGE
7.7 Location Categories.....	38
8. Recommended Planning for Surge Immunity.....	39
8.1 General.....	39
8.2 Reconciling Equipment Susceptibility and Environment Hostility.....	39
8.3 Worst-Case Design and Economic Trade-Off.....	41
8.4 Surge Effects.....	42
8.5 Selection of Waveforms.....	44
9. Definition of Standard Surge-Testing Waveforms.....	44
9.1 General.....	44
9.1.1 100 kHz Ring Wave.....	45
9.1.2 Combination Wave.....	45
9.2 Selection of Peak Values of Standard Waveforms.....	45
9.3 Test Conditions.....	47
9.3.1 Powered Testing.....	47
9.3.2 Verification of the Test Generator.....	48
9.3.3 Tolerances on Most Important Parameter.....	48
9.3.4 Unpowered Testing.....	48
9.4 Detailed Specifications of Waveforms.....	49
9.4.1 0.5 $\mu$ s–100 kHz Ring Wave.....	49
9.4.2 1.2/50–8/20 $\mu$ s Combination Wave.....	50
9.5 Equations for Standard Waveforms.....	51
10. Definition of Additional Surge-Testing Waveforms.....	52
10.1 The Electrical Fast Transient (EFT).....	52
10.1.1 Waveform Definition.....	52
10.1.2 Amplitude.....	53
10.1.3 Test Procedures.....	53
10.2 The 10/1000 $\mu$ s Wave.....	53
10.2.1 Waveform Definition.....	53
10.2.2 Amplitude.....	54
10.2.3 Test Procedures.....	54
10.3 The 5 kHz Ring Wave.....	55
10.3.1 Waveform Definition.....	55
10.3.2 Amplitude.....	55
10.3.3 Test Procedures.....	56
10.4 Equations for Additional Waveforms.....	56
APPENDIXES	
A Data Base.....	59
A1. Initial 1980 Data Base.....	59
A2. Additional Data.....	64
A3. Review of Published Data.....	69
A4. Relative Occurrence of Different Types of Disturbances.....	74
A5. Differences in Amplitudes.....	74
A6. Differences in Waveforms.....	75
B Additional Information.....	79
B1. Amplitudes of Strikes.....	79
B2. Amplitude Spectral Density.....	80

SECTION	PAGE
B3. Changes in the Environment .....	80
B4. Description Versus Specification .....	81
B5. Differential Mode and Common Mode .....	81
B6. EFT Test .....	83
B7. Energy Delivery Capability .....	83
B8. Expected Occurrence of Lightning .....	85
B9. Failure Rate Observations .....	85
B10. Installation Categories .....	87
B11. Interface Devices .....	87
B12. Level Versus Rate of Occurrence .....	87
B13. Low-Voltage System Oscillatory Surges During Lightning .....	90
B14. Multiple Strokes and Total Energy .....	90
B15. Open-Circuit Voltages and Wiring Sparkover .....	90
B16. Per-Unit .....	90
B17. Power System Source Impedance .....	91
B18. Sparkover of Clearances .....	91
B19. Surge Impedance and Source Impedance .....	91
B20. Surge Voltage .....	92
B21. Switching Surges .....	92
B22. Timing of Surges With Respect to Power Frequency .....	92
B23. Utilities Interconnections and Interactions .....	93
B24. VDE 0160 [B94] High-Energy Test .....	94
B25. Worst Case .....	96

C Annotated Bibliography .....	99
C1. Bibliographic Information About References .....	99
C2. Recorded Occurrences and Computed Simulations .....	100
C3. Propagation, Attenuation, and Mitigation .....	105
C4. Reviews and Discussions .....	106
C5. Measurement Techniques and Test Methods .....	108
C6. Related Standards .....	111

#### FIGURES

Fig 1 Simplified Relationships Between Voltage, Duration, Rate of Change, and Their Effects on Equipment .....	19
Fig 2 Relative Number of Transients as a Function of Amplitude .....	26
Fig 3 Comparison of the Slopes of the Frequency of Occurrence Versus Peaks of the Surges Among Six Site Surveys .....	27
Fig 4 Amplitude Spectral Density at Four Sites .....	27
Fig 5 Statistical Evaluation of Recorded dv/dt Data, as a Function of the Maximum Transient Amplitude .....	28
Fig 6 Rate of Surge Occurrences Versus Voltage Level at Unprotected Locations .....	31
Fig 7 Isokeraunic Levels for the United States .....	33
Fig 8 Isokeraunic Levels for the World .....	34
Fig 9 Location Categories .....	40
Fig 10 Concept of Surge Immunity .....	42
Fig 11 100 kHz Ring Wave .....	45
Fig 12 Combination Wave, Open-Circuit Voltage .....	45
Fig 13 Combination Wave, Short-Circuit Current .....	45

Fig 14	Features of the Nominal 8/20 $\mu$ s Waveform: Front Time, Virtual Origin, and Duration .....	50
Fig 15	Waveform of the EFT Pulse .....	52
Fig 16	Pattern of EFT Bursts .....	53
Fig 17	Waveform for 10/1000 $\mu$ s Current Surge.....	54
Fig 18	Waveform for 5 kHz Ring Wave .....	55

## APPENDIX FIGURES

Fig A1	Typical Oscillograms.....	60
Fig A2	Typical Oscillograms.....	61
Fig A3	Injected Current Impulse: 500 A/div and 5 $\mu$ s/div.....	62
Fig A4	Open-Circuit Recording: 500 V/div and 2 $\mu$ s/div.....	62
Fig A5	Recording With 130 $\Omega$ Load: 500 V/div and 2 $\mu$ s/div.....	62
Fig A6	Discharge Current at Maximum Injection: 500 V/div and 2 $\mu$ s/div .....	62
Fig A7	Rates of Surge Occurrence Recorded in a 220 V System .....	63
Fig A8	Effect of System Voltage on Transient Overvoltages for Three-Pulse Durations.....	63
Fig A9	Combined Transient Recording Data.....	64
Fig A10	Voltage Pulse Accompanying Break of Current .....	64
Fig A11	Measured Overvoltage Factors for Short Circuits Behind a Branch-Circuit Fuse .....	65
Fig A12	Influence of Cable Length on Overvoltage at End of Cable.....	65
Fig A13	Surge With High Peak (1500 V) but Relatively Short Duration (100 $\mu$ s) .....	66
Fig A14	Short With Long Duration but Relatively Low Amplitude .....	66
Fig A15	Surge, Recorded in the 480 V System, Produced by Switching On a 5.4 MVAR Bank at the 23 kV Utility Substation.....	66
Fig A16	Typical Capacitor Switching Transient Recorded on a 120 V rms System.....	67
Fig A17	Local Capacitive Load Switching .....	67
Fig A18	Capacitor-Switching Transient Recorded in a Hospital Environment .....	68
Fig A19	Typical Industrial Capacitor-Switching Transient (Low-Voltage Bank).....	68
Fig A20	Lightning-Induced Ring Wave.....	69
Fig A21	Conversion of a Unidirectional Surge Into an Oscillatory Surge.....	70
Fig A22	Swells Occurring Upon Recovery From a Remote System Fault.....	71
Fig A23	Possible Explanation for Low Values of Reported Transients.....	75
Fig A24	Comparison of Waveforms Reported in the Literature .....	77
Fig B1	Division of Lightning Current Among Multiple Paths.....	79
Fig B2	Amplitude Spectral Density for Total of Goedbloed Data.....	80
Fig B3	Common Mode and Differential Mode in a Balanced Transmission Line .....	82
Fig B4	Capacitive Divider Effect in EFT Test .....	83
Fig B5	Direct Coupling of EFT Pulses Into the AC Mains Connection of the EUT .....	84
Fig B6	Coupling Clamp for EFT Test .....	84
Fig B7	Lightning Ground Flash Density, 1987 (Data for Eastern United States Only) .....	86
Fig B8	Similarities and Differences Between the Location Categories Concept of This Recommended Practice and the Installation Categories of IEC 664 (1980) [4].....	89
Fig B9	Effect of the Relative Polarity of Surges and Mains Voltage on Interpretation of "Per-Unit".....	91
Fig B10	Example of Interconnection and Interaction of Utilities for Typical US Practice .....	95
Fig B11	Waveform and Phase Position of the 100/1300 $\mu$ s Surge of VDE 0160 [B94] .....	96
Fig B12	Duration-Amplitude Profile for the "100/1300" $\mu$ s VDE 0160 [B94] Surge .....	97

SECTION	PAGE
<b>TABLES</b>	
Table 1	Summary of Site Surveys ..... 25
Table 2	Summary of Applicable Standard and Additional Waveforms for Location Categories A, B, and C ..... 44
Table 3	Standard 0.5 $\mu$ s–100 kHz Ring Wave ..... 46
Table 4	Standard 1.2/50 $\mu$ s–8/20 $\mu$ s Combination Wave ..... 46
Table 5	Neutral-Ground Mode ..... 47
Table 6	Equations for Standard Surge-Test Waveforms ..... 51
Table 7	Levels for EFT Burst ..... 53
Table 8	Levels for the Additional 10/1000 $\mu$ s Waveform ..... 55
Table 9	Levels for the Additional 5 kHz Ring Wave ..... 56
Table 10	Equations for Additional Surge-Test Waveforms ..... 57
<b>APPENDIX TABLES</b>	
Table A1	Number of Houses With Repetitive Surge Activity Above 1200 V ..... 61
Table A2	Surge-Counter Recordings Above 1200 V (Spring, Summer, and Fall) ..... 61
Table A3	Capacitor Energizing Surges ..... 66
Table B1	Capacitance Value Specified for the Test Generator, According to the System Voltage and the Equipment Class ..... 96

www.Lisungroup.com

# IEEE Recommended Practice on Surge Voltages in Low-Voltage AC Power Circuits

## 1. Scope

The purpose of this recommended practice is to provide information on surge voltages in low-voltage<sup>1</sup> ac power circuits. With this information, equipment designers and users can evaluate their operating environment to determine their need for surge-protective devices. The document characterizes electrical distribution systems in which surges exist, based upon the data that have been recorded in interior locations on single-phase and three-phase residential, commercial, and industrial power distribution systems.

There are no specific models that are representative of all surge environments; the complexities of the real world need to be simplified to produce a manageable set of standard surge tests. To this end, a surge environment classification scheme is presented. This classification provides a practical basis for the selection of surge-voltage and surge-current waveforms and amplitudes that may be applied to evaluate the surge withstand capability of equipment connected to these power circuits. It is important to recognize that proper coordination of equipment capability and environment characteristics is required: each environment and the equipment to be protected has to be characterized and the two reconciled.

The surges considered in this document do not exceed one-half period of the normal mains waveform in duration. They may be periodic or random events and may appear in any combination of line, neutral, or grounding conductors. They include those surges with amplitudes, durations, or rates of change sufficient to cause equipment damage or operational upset (see Fig 1). While surge-protective devices acting primarily on the amplitude of the voltage are often applied to

divert the damaging surges, the upsetting surges may require other remedies.

Test procedures are described in IEEE C62.45-1987 [8],<sup>2</sup> as a companion to the present document. Other surge-related standards are identified in Section 4; the present document is intended to complement these standards.

## 2. How to Use This Document

**2.1 General.** The purpose of this section is to assist the reader in applying the recommendations of this document to each particular case of interest. The 1980 edition of this document, although presented as a guide, has sometimes been misinterpreted as a performance standard, leading to statements such as "meets the requirements of IEEE Standard 587," which are inappropriate and misleading. To avoid such misinterpretation, this section presents guidance on parameters of application, with a brief outline of the document and the corresponding actions to be taken by the user in achieving the goal of satisfactory surge protection.

**2.2 Achieving Practical Surge Immunity.** No performance requirements are specified in this recommended practice. What is recommended is a rational, deliberate approach to recognizing the variables that need to be considered simultaneously, using the information presented here to define a set of representative situations.

For specific applications, the designer has to take into consideration not only the rates of occurrence and the waveforms described in this document, but also the specific power system

<sup>1</sup>Note that "low voltage" is defined by the IEEE and IEC as up to 1000 V rms.

<sup>2</sup>References in the text, shown as [x], are listed in Section 4. Citations shown as [Bx] are found in Appendix C.



environment and the characteristics of the equipment in need of protection. Therefore, generalized and specific performance requirements cannot be included in this recommended practice.

As an example, the following considerations are necessary to reach the goal of practical surge immunity:

- Protection desired
  - Hardware integrity
  - Process immunity
- Specific equipment sensitivities
- The power environment
  - Surge characteristics
  - Electrical system
- Performance of surge protective devices
  - Protection
  - Lifetime
- The test environment
- Total and relative costs

Answers may not exist to all of the questions raised by the considerations listed above. In particular, those related to specific equipment sensitivities, both in terms of component failure and especially in terms of processing errors, may not be available to the designer. The goal of the reader may be selection among various surge-protective devices and equipment protected by them. Subsets of the parameters in this section may then apply, and the goal of the reader may then be the testing of various surge-protective devices under identical test conditions. The following may guide the reader in identifying parameters, seeking further facts, or quantifying a test plan.

**2.2.1 Protection Desired.** The protection desired may vary greatly depending upon the application. For example, in applications not involving on-line performance, protection may be desired merely to reduce hardware failures by a certain percentage. In other cases, such as data processing or critical medical or manufacturing processes, any interruption or upset of a process may be unacceptable. Hence, the designer should quantify the desired goal with regard to the separate questions of hardware failure and process upset.

**2.2.2 Equipment Sensitivities.** Specific equipment sensitivities should be defined in concert with the above-mentioned goals. The sensitivities will be different for hardware

failure or process upset. Such definitions might include: maximum surge remnant amplitude and duration that can be tolerated, waveform or energy sensitivity, etc.

**2.2.3 Power Environment—Surges.** The applicable test waveforms recommended in this document should be quantified on the basis of the location categories and exposure levels defined herein.

**2.2.4 Power Environment—Electrical System.** The magnitude of the rms power-line voltage, including any anticipated variation, should be quantified. Power system voltages are generally regulated to comply with ANSI C84.1-1989 [1]. That standard specifies two ranges (A and B) of service and utilization voltages and explicitly acknowledges the occurrence of abnormal conditions that cause these voltages to be exceeded. Successful application of surge-protective devices requires taking into consideration these occasional abnormal occurrences. Appropriate selection of the clamping voltage and continuous mains voltage ratings is essential.

**2.2.5 Performance of Surge-Protective Devices.** Evaluation of a surge-protective device should verify a long life in the presence of both the surge and electrical system environments described above. At the same time, its remnant and voltage levels should provide a margin from the sensitivity levels of the equipment to achieve the desired protection. It is essential to consider all of these parameters simultaneously. For example, the use of a protective device rated very close to the nominal system voltage may provide attractive remnant figures, but may be unacceptable when a broad range of occasional abnormal deviations in the amplitude of the mains waveform are considered. Lifetime or overall performance of the surge-protective device should not be sacrificed for the sake of a low remnant (Martzloff and Leedy, 1989 [B46]).

**2.2.6 Test Environment.** The surge test environment should be carefully engineered with regard to the preceding considerations and any other parameters felt important by the user. A typical test-environment description will include definitions of simultaneous voltages and currents, along with demonstrations of proper short-circuit currents. It is important to recognize that specification of an open-circuit voltage without simultaneous short-circuit current capability is meaningless.



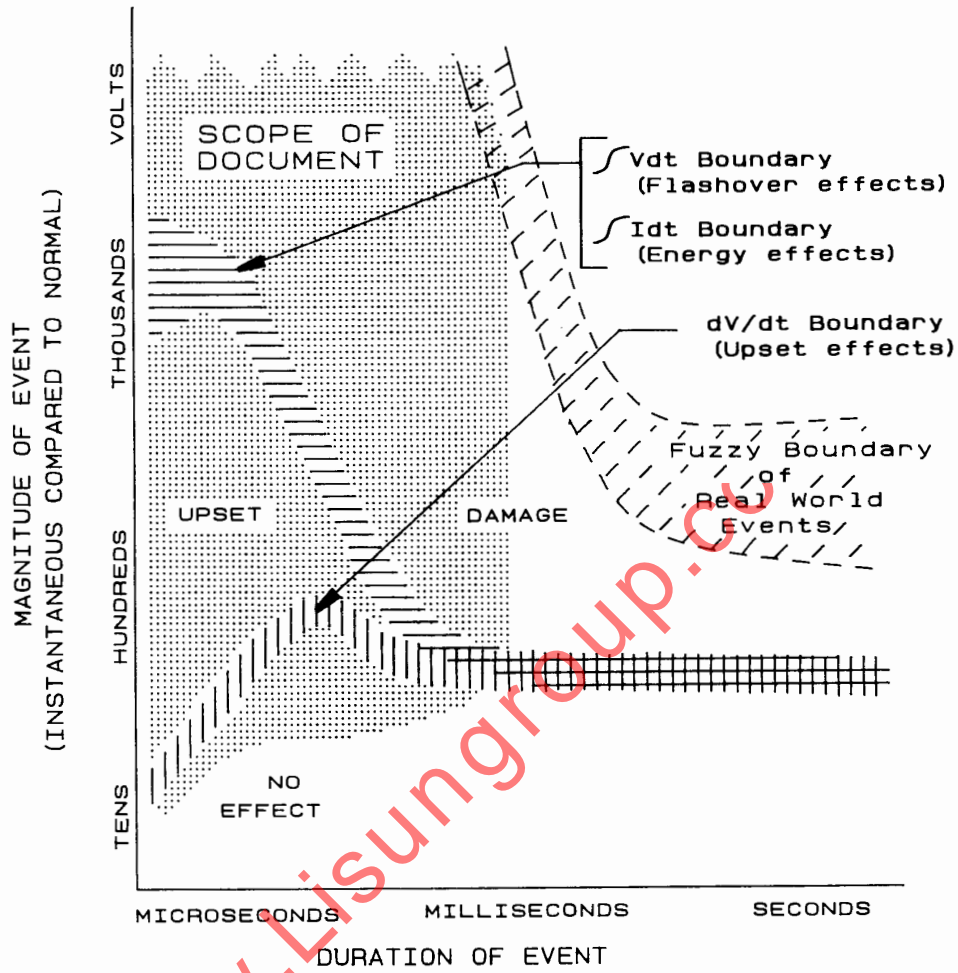

NOTES: (1) The graph shows the relative position of effects and the order of magnitude of the amplitude and duration. Do not attempt to read numerical values from this graph.

(2) The scope of the document is shown by the dotted pattern. The upper limit for the duration is one half-cycle of the applicable power frequency.

(3) The values or positions of the boundaries between "no effect" and "upset," and between "upset" and "damage," vary with the withstand characteristics of the equipment exposed to the surges.

(4) This figure shows one measure of surge severity. Other possible measures include peak current, rise time, and energy transfer.

**Fig 1**  
**Simplified Relationships Between Voltage, Duration, Rate of Change, and Their Effects on Equipment**

**2.2.7 Costs.** The cost of surge protection can be small, compared to overall system cost and benefits in performance. Therefore, added quality and performance in surge protection may be chosen as a conservative engineering approach to compensate for unknown variables in the other parameters. This approach can provide excellent performance in the best interests of the user, while not significantly affecting overall system cost.

**2.3 Document Outline.** To achieve the goal of satisfactory surge protection in specific situations, the equipment user has to quantify the variables discussed in the preceding sections. The following description of each section should aid the user in that process.

*Section 3, Definitions*, presents the definitions of terms for which the IEEE Std 100-1988 [9] does not already provide a definition, or when a special application or extension is made from an existing definition.

*Section 4, References*, lists the documents supporting some of the basic concepts and recommendations of the present document. It is not a bibliography but a list of key documents; Appendix C is a bibliography with annotations presented for detailed information or further reading material.

*Section 5, Origin of Surge Voltages*, presents a brief overview of the mechanisms leading to the occurrence of surge voltages. A more detailed discussion of these mechanisms is presented in Section 7, leading to the selection of representative environments.

*Section 6, Summary of Data Base*, presents an overview of the available data base, with a discussion of the limitations and the resulting assumptions or simplifications made to develop a definition of a representative generic environment.

*Section 7, Recommended Selection of Representative Environments*, presents a rationale for going from the limited data base to the complex environment to a manageable set of a few representative surge waveforms. Two standard waveforms are specified, and three additional waveforms are proposed to represent the environment, but discussion of the selection of levels is deferred until Sections 9 and 10. The concept of *Location Categories*<sup>3</sup> is

<sup>3</sup>Those terms appearing in bold italics in the text are discussed further in Appendix B.

presented in this section. A discussion is also presented on the fallacy of assigning an energy content to a surge regardless of source or load-sharing considerations. Understanding this process of simplification is essential to avoiding the pitfall of blind dependency on a performance specification—which this document is not. In other words, the selection of a representative environment when designing for surge immunity, no matter how carefully made, cannot yield 100% assurance that surge problems will not occur.

*Section 8, Recommended Planning for Surge Immunity*, presents a discussion of the tradeoffs necessary to reconcile the equipment surge withstand capability with the environment, recognizing statistical and economic realities. Issues of surge test equipment are discussed.

*Section 9, Definition of Standard Surge Testing Waveforms*, provides precise information on the standard waveforms proposed in Sections 7 and 8, including tolerances. Recommendations are given in the form of tables proposing severity levels for various environments.

*Section 10, Definition of Additional Surge Testing Waveforms*, provides the same type of information given in Section 9 for the additional waveforms.

*Appendix A, Detailed Data Base*, contains information presented to enhance credibility of the environment description and simplification process.

*Appendix B, Additional Information*, provides detailed background and information that would burden the reader if included in the main sections.

*Appendix C, Annotated Bibliography*, provides the user with a list of published documents for further reading on recorded occurrences and computed simulations; propagation, attenuation and mitigation; reviews and discussions; measurement techniques and test methods; and related standards.

### 3. Definitions

The definitions of the terms used in this document are those found in IEEE Std 100-1988 [9], the *IEC Multilingual Dictionary of Electricity* [3], or the *IEC International Electrotechnical Vocabulary* [B95]. In some

instances, the IEEE definition in the current dictionary may be either too broad or too restrictive; in such a case, an additional definition or note is included in this section.

**mains.** The ac power source available at the point of use in a facility. It consists of the set of electrical conductors (referred to by terms including "service entrance," "feeder," or "branch circuit") for delivering power to connected loads at the utilization voltage level.

**surge (surge-protective device).** A transient wave of current, potential, or power in an electric circuit.

NOTE: The use of this term to describe a momentary overvoltage consisting of a mere increase of the mains voltage for several cycles is deprecated. See **swell**.

**swell.** A momentary increase in the power frequency voltage delivered by the mains, outside of the normal tolerances, with a duration of more than one cycle and less than a few seconds. See **surge**.

#### wave shape designation.

NOTE: On wave shape designation, IEEE Std 100-1988 [9] states that the units used in a wave shape designation are microseconds; to avoid confusion in this document where other units are necessary, units—ns,  $\mu$ s, or ms—are shown after all wave shape designations.

## 4. References

In this document, two types of "references" are used: those that are directly related to the subject being discussed—references—and those that provide supporting information to the subject being discussed—bibliographic citations. For the convenience of the reader in not breaking the pace of reading, "references" and "citations" are briefly identified in the text as described below.

The first type, references, contains information that is implicitly adopted in the present document; complete implementation of the recommendations made in the present document would require the reader to consult that reference for the details of the subject. This first type is introduced in the text as (Document identity, [xx]), and the listing is provided below, in this section.

The second type, citations, is not essential to implementation of the recommendations, but

is provided for the use of readers seeking more detailed information or justification. This second type is introduced in the text as (Author, date [Byy]) and the listing is provided in Appendix C.

This recommended practice shall be used in conjunction with the following publications:

[1] ANSI C84.1-1989 American National Standard Voltage Ratings for Electric Power Systems and Equipment (60 Hz).<sup>4</sup>

[2] ANSI/NFPA 70-1990, National Electrical Code.<sup>5</sup>

[3] IEC Multilingual Dictionary of Electricity. Institute of Electrical and Electronic Engineers, 1983.<sup>6</sup>

[4] IEC 664 (1980), Insulation Coordination Within Low-Voltage Systems Including Clearances and Creepage Distances for Equipment.

[5] IEC 801-4 (1988), Electromagnetic Compatibility for Industrial Process Measurement and Control Equipment—Part Four: Electrical Fast Transient/Burst Requirements.

[6] IEEE C37.90.1-1989 IEEE Standard Surge Withstand Capability (SWC) Tests for Protective Relays and Relay Systems.<sup>7</sup>

[7] IEEE C62.1-1984, IEEE Standard for Gapped-Silicon Carbide Surge Arresters for AC Power Circuits.

[8] IEEE C62.45-1987, IEEE Guide on Surge Testing for Equipment Connected to Low-Voltage AC Power Circuits.

<sup>4</sup>ANSI publications are available from the Sales Department, American National Standards Institute, 11 West 42nd Street, 13th Floor, New York, NY 10036, USA.

<sup>5</sup>NFPA publications are available from Publications Sales, National Fire Protection Association, Batterymarch Park, Quincy, MA 02269, USA.

<sup>6</sup>IEC publications are available from IEC Sales Department, Case Postale 131, 3 rue de Varembe, CH 1211, Genève 20, Switzerland/Suisse. IEC publications are also available in the United States from the Sales Department, American National Standards Institute, 11 West 42nd Street, 13th Floor, New York, NY 10036, USA.

<sup>7</sup>IEEE publications are available from the Institute of Electrical and Electronics Engineers, Service Center, 445 Hoes Lane, P.O. Box 1331, Piscataway, NJ 08855-1331, USA.

[9] IEEE Std 100-1988, IEEE Standard Dictionary of Electrical and Electronic Terms.

[10] IEEE Std 518-1982, IEEE Guide for the Installation of Electrical Equipment to Minimize Noise Inputs to Controllers from External Sources.

## 5. The Origins of Surge Voltages

**5.1 General.** Surge voltages occurring in low-voltage ac power circuits originate from two major sources: lightning effects (direct or indirect) on the power system and system switching transients.

**5.2 Lightning.** Models of lightning effects consistent with available measurements have been made in order to yield predictions of surge levels, even if the exact mechanism underlying the production of any particular surge is unknown. The major mechanisms by which lightning produces surge voltages are the following:

- (1) A nearby lightning strike to objects on the ground or within the cloud layer produces electromagnetic fields that can induce voltages on the conductors of the primary and secondary circuits.
- (2) Lightning ground-current flow resulting from nearby cloud-to-ground discharges couples onto the common ground impedance paths of the grounding network, causing voltage differences across its length and breadth.
- (3) The rapid drop of voltage that may occur, when a primary gap-type arrester operates to limit the primary voltage, is coupled through the capacitance of a transformer and produces surge voltages in addition to those coupled into the secondary circuit by normal transformer action.
- (4) A direct lightning strike to high-voltage primary circuits injects high currents into the primary circuits, producing voltages by either flowing through ground resistance and causing a ground potential change or flowing through the surge impedance of the pri-

mary conductors. Some of this voltage couples from the primary to the secondary of the service transformers, by capacitance or transformer action or both, thus appearing in low-voltage ac power circuits.

- (5) Lightning strikes the secondary circuits directly. Very high currents and resulting voltages can be involved, exceeding the withstand capability of equipment and conventional surge-protective devices rated for secondary circuit use.

**5.3 Switching Transients.** System switching transients can be divided into transients associated with normal or abnormal conditions, as follows:

- (1) Minor switching near the point of interest, such as an appliance turnoff in a household or the turnoff of other loads in the individual system.
- (2) Periodic transients (voltage notching) that occur each cycle during the commutation in electronic power converters. The voltage notch is caused by a momentary phase-to-phase short circuit with a rapid change in voltage, lasting in the 100  $\mu$ s range.
- (3) Multiple reignitions or restrikes during a switching operation are another example. Air contactors or mercury switches can produce, through escalation, surge voltages of complex waveforms and of amplitudes several times greater than the normal system voltage.
- (4) Major power system switching disturbances, such as capacitor bank switching, fault clearing, or grid switching. Transient overvoltages associated with switching of power-factor correction capacitors have levels, at least in the case of restrike-free switching operations, of generally less than twice the normal voltage, though the levels of the transients often can be 1.5 times normal (that is, the absolute value may be 2.5 times the normal peak). These transients can occur daily, and their waveforms generally show longer time durations, such as several hundred microseconds, compared to typical durations on the order of microseconds to

- tens of microseconds for other switching events and lightning-induced transients. If multiple reignitions or restrikes occur in the capacitor switching device during opening, then the transient overvoltage can exceed three times the normal system voltage and involve high energy levels.
- (5) Various system faults, such as short circuits and arcing faults. One type of switching transient, for example, results from fast-acting overcurrent protective devices such as current-limiting fuses and circuit breakers capable of arcing times of less than 2  $\mu$ s. These devices leave inductive energy trapped in the circuit upstream; upon collapse of the field, high voltages are generated.

The most visible effect of a switching surge is generally found on the load side of the switch and involves the equipment that is being switched, as well as the switching device. In the case of the equipment being switched, the prime responsibility for protection rests with either the manufacturer or the user of the equipment in question. However, the presence and source of transients may be unknown to the users of this equipment. This potentially harmful situation occurs often enough to command attention.

## 6. Summary of Data Base

**6.1 General.** Disturbances on low-voltage ac power circuits ("mains") can be classified in many ways, such as a voltage increase or reduction from the nominal rms value, a voltage or current wave shape variation, and the surge waveform characteristics. The latter include amplitude, duration, rise time, frequency of ringing, polarity, energy delivery capability, amplitude spectral density, position with respect to the phase of the mains waveform, and frequency of occurrence.

The scope of this document is limited to disturbances that have a duration of less than one half-cycle of the normal mains waveform. Consequently, the issues of disturbances caused by other events such as sags, outages, swells, and harmonic distortions are not addressed in this discussion of the data base,

regardless of their importance or rates of occurrence compared to those of surges.

It is difficult to assign minimum or maximum values to some of the surge characteristics because the effect and hence the significance depends on the nature of the equipment subjected to the surge. Some of these disturbances occur without causing any problem with the equipment, some can cause equipment upset, and others can cause equipment damage (Fig 1).

Surge amplitude alone is not the sole criterion for immunity in the design and testing of equipment. However, the data available at the time of the 1980 version of this document were based on the general use of peak-reading instruments, with few oscilloscopes. Hence, the information on waveform was more limited than the information on peak amplitude. When attempting to correlate the data collected by many researchers over the years, no agreement is found on the voltage amplitude below which the surges lose significance. Different perceptions on what should be considered as "noise" in contrast to a "surge" also exist (IEEE C62.45-1987, [8]; IEEE Std 518-1982 [10]).

Characterization of surges is further complicated by diverse perceptions of the significance of other parameters, such as the rate of change of the surge voltage and the amplitude spectral density of the surge (Rhoades, 1980 [B64]; Goedbloed, 1987 [B14]), the energy delivery capability of the surge (Martzloff, 1986 [B22]), the threshold of the susceptible circuits (Rhoades, 1981 [B65]), and the threshold level of the instrument used to collect the data (Goldstein and Speranza, 1983 [B15]; Martzloff and Gruz, 1987 [B61]).

In this section, a summary discussion of the data base is presented. A more detailed description of the data base is presented in Appendix A. From this data base, the recommendations presented in Sections 7, 8, 9, and 10 were developed by consensus.

The highest confidence level is found in the expected peaks and rates of occurrence; other data on the surge environment have a narrower basis, but can still be used for guidance until broader data are published and integrated as an international effort.

**6.2 Notations and Definitions.** A surge on the ac mains can be described as a time-domain



phenomenon; terms used to describe such an event should have definitions applicable to all measurements. The reader should review the definitions given in Section 3 and the notes in Appendix B for the refinements or changes to commonly used terms. In particular, note that units will be shown after the designation of a waveform, for example, 5/50 ns.

Design of equipment for surge immunity requires knowledge of how the surge is presented to the equipment: the designer needs to know the surge mode of coupling. To avoid the ambiguities that may occur when using the term "common mode" (see Appendix B5), the following notations are used in this document:

**L-N:** Measurement from phase(s) to neutral for both single- and three-phase systems.

**L-L:** Measurements from phase to phase in a polyphase system, or from one line to the other line in a single phase system.

**L-G:** Measurements from phase to equipment grounding conductor at the line terminals of utilization equipment. In North American single-phase systems and three-phase five-wire systems, the equipment grounding conductor is bonded to the neutral conductor at the service entrance.

**N-G:** Measurements from neutral to equipment grounding conductor at the line terminals of the utilization equipment.

**6.3 Site Surveys of Power Quality.** Monitoring of mains voltage is in some cases a logical first step to determine the power quality at a specific site. However, the results are only a snapshot of the quality because the characteristics of the measured surges vary over time as loads and system configurations change. Seasonal variations and geographic location also influence the results, in particular for lightning effects. Past site surveys of power quality can help determine the probabilistic external transients. A chronological review of several site surveys is shown in Table 1.

Early site surveys were limited by instrument bandwidth in the measurements of high-amplitude, fast rise-time transients. With improving detection capability in the instrumentation resulting in some changes in the recorded results, this original limitation could lead to the false conclusion that power quality has degraded over the years.

About 1960, researchers began to measure the surge transients on low-voltage lines as the transition from vacuum tubes to semiconductor design occurred and semiconductor failures became an issue. Because the monitoring instruments reflected technology available at the time of measurement, the early data are very limited.

Early site surveys had several limitations:

- (1) They were only differential mode measurements (L-N or L-L)
- (2) They did not always record the highest surge peak in an event
- (3) They rarely recorded the surge waveform or duration
- (4) They did not record the surge ringing period
- (5) They did not give any data on the repetition rate of surge bursts
- (6) They did not provide critical parameters of rate of rise, rate of voltage change, or energy delivery capability

**6.4 Field Experience.** In addition to site surveys, observations of failure rate can also provide data on the occurrence of surges. For instance, as detailed in Appendix A, three observations have been reported:

- (1) A 100 to 1 reduction occurred in the failure rate of some clock motors when their voltage withstand was raised from 2 000 V to 6 000 V (Martzloff-Hahn, 1970 [B22]). Because of the large sample and duration of the observation, this ratio in failure rate and, therefore, the relative occurrence of the two levels, has high credibility.
- (2) Many incandescent light bulbs typically fail by internal flashover when subjected to surges above 1500 V. Since this failure level does not produce an unacceptable rate of premature failure among millions of light-bulb users, there has to be a corresponding upper bound on the rate of occurrence of surges above 1500 V at the locations of light-bulb sockets.
- (3) Metal oxide varistors of 20 mm diameter or less, installed at some service entrances, have been informally reported to fail occasionally, while their performance within a building has been

reported as acceptable. To the extent that these failures can be attributed to surge energy deposition in excess of the varistor rating (Martzloff and Leedy, 1989 [B46]), this observation can be used to obtain a gross estimated magnitude of energy-delivery capability of surges at these two locations, supporting the concept of *Location Categories* presented in this document.

**6.5 Summary of Surge Characteristics.** The combination of data from published surveys, anecdotes, and observed failure rates yields information used to develop the qualitative

and quantitative recommendations of Sections 7, 8, and 9, as well as the suggestions of Section 10. In the following paragraphs, a summary is presented on the aspects of amplitude versus rate of occurrence, surge duration, ringing frequency, rate of voltage change, energy delivery capability, and effects of loading conditions.

**6.5.1 Peak Amplitude Versus Rate of Occurrence.** The peak amplitude versus occurrence of surges depends on the type of service and on the location where measurement is made (IEEE Committee Report, 1970 [B57]; Rhoades, 1979 [B63]). Overhead distribution lines usually have the highest surge amplitude (5 kV to

**Table 1**  
**Summary of Site Surveys**

Survey	Period	Locale	System Voltage	System Type*	Instrument	Connection Mode	Power Frequency Filtered Out
B-N	Circa 1962-1963	Great Britain	240	Industrial and residential	Analog multithreshold	Not stated	Yes
M-H	1963-1967	US	120/240 277/480	Residential and industrial	Analog single-threshold Oscilloscope and Camera	L-N	No
Can	Circa 1969-1970	US Navy	120 450	Shipboard	Oscilloscope and Camera	L-L (ungrounded)	No
A-S	1969-1972	US	Not stated	Computer sites	Screen storage oscilloscope Oscillograph Digital multiparameter	Not stated	Not clear
G-S	1977-1979	US	120/208	Telephone facilities	Digital multiparameter	L-N	Yes
WBB	Circa 1982-1983	Sweden	220/380	Industrial	Digital multiparameter Digital storage oscilloscope	Common (unclear)	Yes
AEM	1982-1983	US (Alaska)	120/240	Isolated systems	Digital multiparameter	L-N	Yes
O-B	1982-1983	US	120/240 120/208 277/480	Industrial and computer sites	2-point digital V & I: Peak amplitude and time Time to 50% of peak	L-N (V) Series (I)	No (V) Yes (I)
Goe	Circa 1983-1984	Europe	220/380	Industrial and miscellaneous	Two digital waveform recorders (fast and slow)	L-G	Yes

\* Principal type stated first.

Source: Martzloff-Gruzs [B61]

**LEGEND:**

B-N = Bull-Nethercot [B6]  
M-H = Martzloff-Hahn [B22]  
Can = Cannova [B7]  
A-S = Allen-Segal [B2]  
G-S = Goldstein-Speranza [B15]

WBB = Wernström et al. [B34]  
AEM = Aspnes et al. [B3]  
O-B = Odenberg-Braskich [B28]  
Goe = Goedbloed [B14]



20 kV), whereas surge amplitudes within a building may be limited by flashover of clearances (IEC 664 (1980) [4]) or by the propagation characteristics of the wiring system (Martzloff, 1990 [B48]).

Seasonal and time-of-day variations can also affect the occurrence (Allen and Segall, 1974 [B2]). Most high-amplitude surges are caused by lightning, so that geographic location and time of the year affect the rate of occurrence (Martzloff and Hahn, 1970 [B22]; Haruki et al., 1989 [B16]). However, these published site surveys contain few occurrences specifically identified as lightning-related.

As an example of survey results, Fig 2 shows an average number of occurrences per year from several sites. As expected, the number of events decreases for higher peaks. Observe that from 100 V to 400 V, the events almost follow a  $V^{-4}$  slope, then a lower and almost linear rate ( $V^{-1}$ ) from 400 V to 1200 V, and finally above 1200 V, the events follow a  $V^{-2}$  slope. Furthermore, plotting the frequency of occurrence versus peak values from many surveys yields the remarkable result of comparable slopes, but different specific numbers of occurrences (see Fig 3).

In conclusion, all events from early to late surveys show that the number of surge events decreases with increasing crest voltage, at the power of  $V^{-a}$ , where  $a$  varies from 1 to 4. From Fig 2 and Fig 3, the relationship is typically  $N = V^{-3}$ , where  $N$  is the relative number of surges. Thus, a probabilistic analysis is required to determine the expected crest amplitude for a specific location, and the decision to provide a specific level of equipment immunity and margin can only be made on a risk analysis tradeoff.

**6.5.2 Duration.** Those surveys that report complete waveform recordings show a wide range of durations, ranging from a fraction of a microsecond (Wernström et al., 1984 [B34]) to a few milliseconds (Meissen, 1983 [B25]) for unidirectional or quasi-unidirectional waveforms. Oscillatory waveforms, with ringing frequencies discussed below, have been observed with durations of one or two cycles to about ten cycles of the ringing frequency. Examples of these durations are given in Appendix A.

**6.5.3 Ringing Frequency.** The ringing frequencies cited in surveys cover the range of relatively low frequencies, a fraction of a

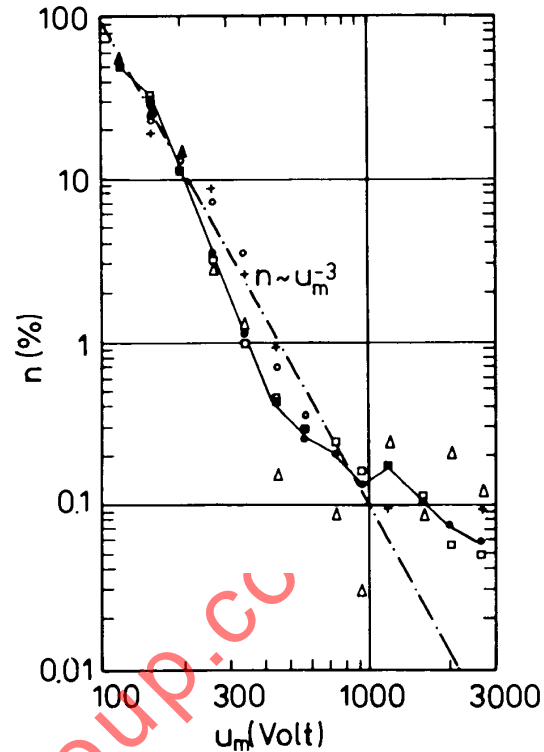

LEGEND

- = Total
- = Industrial
- △ = Business
- = Domestic
- + = Laboratory

Source: Goedbloed [B14]

**Fig 2**  
**Relative Number of Transients as a Function of Amplitude**

kilohertz, up to one megahertz. The lower frequencies result from capacitor bank switching transients, while the higher frequencies are the result of the natural oscillation of local circuit elements or of multiple reflections in a wiring system of limited dimensions (Standler, 1989 [B68]). Fig 4 shows one example of report from a recent survey, expressed in *amplitude spectral density*.

**6.5.4 Voltage Rate of Change.** Recent surveys have presented the results in the form of statistical distributions relating rate of rise ( $dv/dt$ ) to other parameters of the surges. Typical data for sites without lightning transients are shown in Fig 5. In that figure, the upper

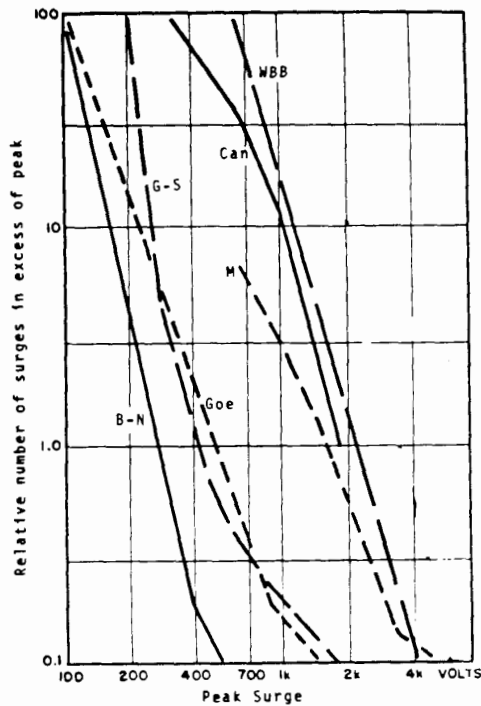

**LEGEND**  
 B-N = Bull-Nethercott (composite)  
 M = Martzloff  
 Can = Cannova  
 G-S = Golstein-Speranza  
 WBS = Wernstrom et al (upper limit)  
 Goe = Goedbloed

Source: Martzloff-Gruzs [B61]

**Fig 3**  
**Comparison of the Slopes of the Frequency of Occurrence Versus Peaks of the Surges Among Six Site Surveys**

limits of the rate of change are above 100 V/ns, even at low peak voltages such as 500 V. This form of data presentation will be helpful to designers of circuits sensitive to coupled disturbances, but the present data base is still limited.

**6.5.5 Energy Delivery Capability.** Recent surveys have addressed the issue of energy delivery capability in various manners. As discussed in Section 7, the significant parameter is not the "energy contained in the surge" but

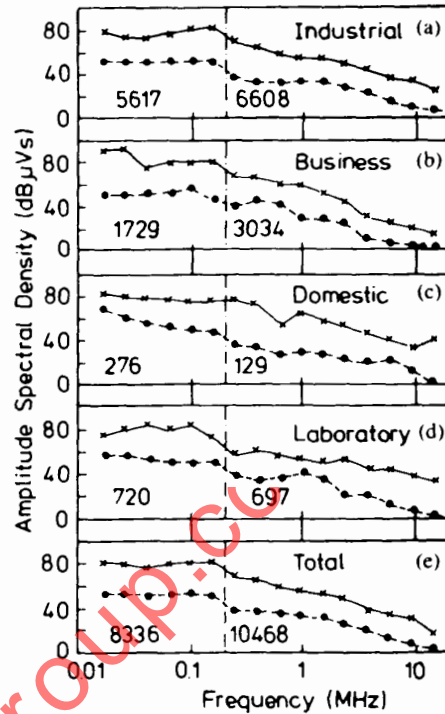

Upper lines: 99.8%  
 Lower Lines: 50% (mean)  
 (for 3  $\sigma$  levels)

Source: Goedbloed, 1987 [B14]

**Fig 4**  
**Amplitude Spectral Density at Four Sites<sup>8</sup>**

the actual energy that can be deposited in a surge-absorbing device. One survey author (Goedbloed, 1987 [B14]) proposes an "energy measure" parameter, defined as the product of the voltage square by the time duration of the voltage.

<sup>8</sup>For each site, the number of reported events is shown below and above a 200 kHz boundary in the frequency scale. Individual surges and individual sites of specific ring wave frequency produce a peaked distribution of amplitude and spectral density (Standler, 1989 [B68]). When many surges and sites are combined, such as in this figure, the result is a broad and declining distribution. Therefore, a distinction should be made between single events as they impact a specific piece of equipment having specific frequency response, and the composite result shown in this figure.

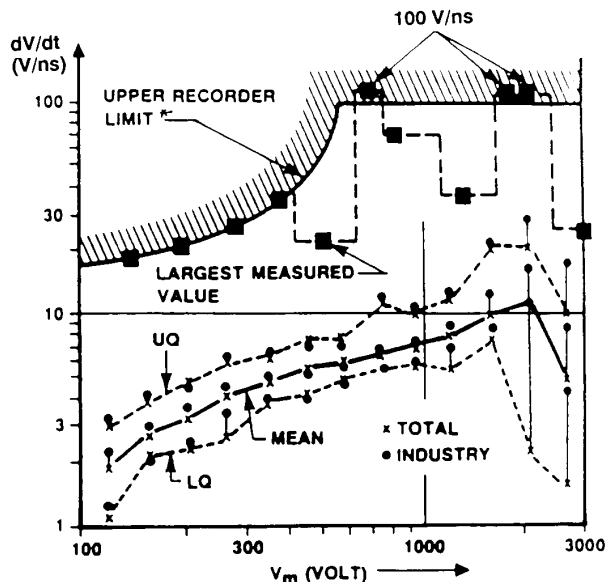

NOTE: Upper limits of the rate of change shown in this figure were added to the original data from Goedbloed [B14]. The recorder did not always measure the maximum value of  $dv/dt$ .

**Fig 5**  
**Statistical Evaluation of Recorded  $dv/dt$  Data,**  
**as a Function of the Maximum Transient**  
**Amplitude**

This approach is justifiable for a resistive load, where the power dissipated in the resistor is  $V^2/R$ . For a nonlinear surge-protective device, the relationship is not so simple. Furthermore, the concept of recording the “energy measure” may promote the arbitrary reporting of “surge energy” by assuming a value for the impedance and then quoting results in joules.

While there is definite merit in an attempt to describe the capability of a surge for delivering energy to circuit components, readers should realize that “energy” reports have to be evaluated with a clear understanding of the underlying assumptions. The “energy in the surge” cannot be determined from measurements of voltage alone (Standler, 1989 [B83]). As progress continues in the development of power-system disturbance monitors, the data base could be expanded by making appropriate

measurements of the surge current diverted by generic surge-protective devices installed at the point of monitoring (Martzloff, 1985 in discussion of [B29]; Standler, 1987 [B85]).

A distinction should be made between surges of high amplitude with short duration and surges of high amplitude with long duration. The first have the potential of upsetting equipment operation but involve little energy, while the second of these have the potential for high levels of energy deposition.

**6.5.6 Effects of Location, Loads, and Mode of Coupling.** Disturbance recording results are not very sensitive to the location of the disturbance monitor within a building, with the exception of the fast transients (Martzloff, 1990 [B48]). However, the changes in the loads will affect the response of a system to impinging surges. The mode of coupling is important and has not been well defined in the earlier surveys (Martzloff and Gruzs, 1988 [B61]). In addition to the issue of citing results as L-L, L-N, L-G, or N-G voltage measurements, another issue that has not been addressed is that of voltage differences appearing between the power-system conductors and conductors from other systems, such as a communication system, a control system, or even building steel. Voltage differences between systems can occur during power-system faults and lightning discharges; the present data base does not recognize these. See *utilities interconnections and interactions* in Appendix B23 for a more comprehensive discussion.

## 7. Recommended Selection of Representative Surges

**7.1 General.** The data base summarized in Section 6, along with anecdotal information, illustrates the wide variety of surges that can be expected to occur in low-voltage ac power systems. Evaluation of the ability of equipment to withstand these surges, or of the performance of surge-protective devices, can be facilitated by a reduction of the data base.

It is unnecessary to subject equipment to surges that would duplicate field-measured surges, since these measurements are site dependent (Martzloff and Gruzs, 1988 [B61]) and are likely to change with time.

The reduction process leads to selecting a few representative surges that will make subsequent laboratory tests uniform, meaningful, and reproducible. Since the environment is subject to change both for the better and the worse, it would be prudent to use these representative surges as a baseline environment. However, this simplification should not bar any user from performing evaluations for different surge-environment conditions if knowledge is available for a particular environment (over a sufficient period of time, such as one or more years) and the requirements warrant the cost and effort of additional tests.

To assist equipment designers and user in making appropriate choices, this recommended practice outlines several exposure levels among several location categories that will be defined further in this section. A combination in the selection of location category and exposure level will then provide the appropriate degree of compromise between a conservative overdesign and a cost-conscious reduction of margins.

The objective of this recommended practice is to lead to an appropriate choice among the levels cited on the basis of the rationale presented here. However, the goal is not to assign arbitrarily any given level to a generic class of equipment. This assignment remains the prerogative and the responsibility of the users and the manufacturers of specific equipment classes.

**7.2 Simplification of the Data Base.** This recommended practice provides a matrix from which a selection can be made and therefore a common base of reference for specifying equipment performance requirements. Note that the specification of these individual equipment requirements is outside of the scope of this document. However, a first and necessary step in the process of addressing concerns of surge effects on equipment is to determine, by design review or by tests, the susceptibility or vulnerability of the equipment to impinging surges.

The process of simplifying the complex environment involves three further steps:

- (1) Identify the environment (outside or inside building) and operating conditions in unprotected circuits.
- (2) Select a minimum number of surge waveforms that are representative of the postulated environment. This recommended practice provides the basis for this selection.
- (3) The last step will depend on the point of view of the designer or the user of the equipment of interest. Two cases should be considered:
  - Case 1:* When the equipment is sensitive to voltage or current peaks and durations (equipment upset or damage is the concern here), the significant parameters are primarily the amplitude and duration of the surge.
  - Case 2:* When the equipment is sensitive to the rate of change in the voltage of the mains (equipment upset is the major concern here), the significant parameter is primarily the rate of change. Rate-of-change effects can cause equipment upset for surge amplitudes far below those involved in hardware damage, even for amplitudes that do not exceed the envelope of the power frequency sine wave.

Fig 1 presents a schematic and simplified view of relationships between time, voltage, current, and the rates of change. An additional concern is the number of occurrences. The rate of occurrences is a significant parameter when the equipment is sensitive to the number of surges occurring in a given time period. Some equipment or its protective circuits may eventually fail as a result of being degraded by multiple surges that, individually, would not cause failure.

The three steps of the simplification process are discussed in detail in 7.3, 7.4, and 7.5. These selections will ultimately be used as the basis for specifying surge tests. Therefore, they should be limited to a reasonable number to avoid impractical test requirements.

### 7.3 Rate of Occurrence and Voltage Levels in Unprotected Circuits

**7.3.1 General.** The rate of occurrence of surges varies over wide limits, depending upon the particular power system. Prediction of the rate for a particular system is always difficult and frequently impossible. The rate is related to the level of the surges; low-level

surges are more prevalent than high-level surges.

It is essential to recognize that a surge voltage observed in a power system can be either the original surge or the remnant resulting from the sparkover of some clearance or the operation of a protective device in the system. Hence, the term "unprotected circuit" should be understood to be a circuit in which no known low-voltage protective device has been installed, but in which the *sparkover of clearances* will eventually limit the maximum voltage of the surges.

The distribution of surge levels, therefore, is influenced by the surge-producing mechanisms as well as by the sparkover level of clearances (between energized parts, as well as between energized parts and ground) and the operation of unidentified protective devices. It is important to recognize the effect of the increasing number of surge-protective devices installed in and around equipment (see *changes in the environment* in Appendix B3).

This distinction between actual driving voltage and voltage limited by sparkover is particularly important at the interface between outdoor equipment and indoor equipment. Outdoor equipment may have higher clearances, hence higher sparkover levels; 10 kV may be typical, but 20 kV is possible (peak values for a 1.2/50  $\mu$ s wave). At the service entrance, watt-hour meters may include protective gaps between phase conductors and ground with sparkover levels in the range of 8 kV. In contrast, most indoor wiring devices used in 120 V, 240 V, and 480 V systems have sparkover levels between phases or between phase and ground of about 6 kV. Therefore, this 6 kV level can be selected as a typical but not a guaranteed limit for the magnitude of surges in an indoor power system.

NOTE: This 6 kV limit is stated as an upper limit that is unlikely to be exceeded in typical low-voltage, indoor environments, for the reasons stated. It is not to be construed as a mandatory surge withstand requirement for all load equipment.

**7.3.2 Rate of Occurrence Versus Voltage Level.** Data collected from many sources (see the data base in Appendix A) have led to the log-log plot shown in Fig 6. This plot shows the crest values of surges, regardless of their waveform and location of recording, from a composite of all recordings reported in the literature, as indicated in Fig A9 of Appendix A.

The data reported by many observers at the sites they monitored show decreasing numbers of occurrence for higher crests, with a slope that is independent from the site. The absolute number of occurrences, however, varies from site to site. Thus, if a limited set of recordings can establish the rate of occurrences for the more probable events at low amplitudes, then the events of higher amplitude that are less likely to occur might be extrapolated or estimated from the general slope (Goldstein and Speranza, 1982 [B15]).

The three regions shown in Fig 6 and labeled low, medium, and high exposure present the data in empirical form that is applicable, if some knowledge is available or if some assumption is made on the "exposure level" of the site, as defined below.

**7.3.3 Exposure Levels.** The exposure level of the environment can be related to exposure of the power system to induced surges. The following descriptions are offered on the exposure levels:

- (1) *Low Exposure.* Systems in geographical areas known for low lightning activity, with little load or capacitor switching activity.
- (2) *Medium Exposure.* Systems in geographical areas known for medium to high lightning activity, or with significant switching transients.  
Both or only one of these causes may be present, as it is difficult to separate them in reviewing the results of monitoring disturbances.
- (3) *High Exposure.* Those rare installations that have greater surge exposures than those defined by Low Exposure and Medium Exposure. The more severe conditions result from extensive exposure to lightning or unusually severe switching surges.

The high-exposure level needs to be recognized, *but it should not be indiscriminately applied to all systems.* Such general application would penalize the majority of installations, where the exposure is lower (see *amplitudes of strikes* in Appendix B1).

Several major sources of surges have been identified; the definition of "exposure" depends on which source is involved. The frequency of occurrence and level of lightning



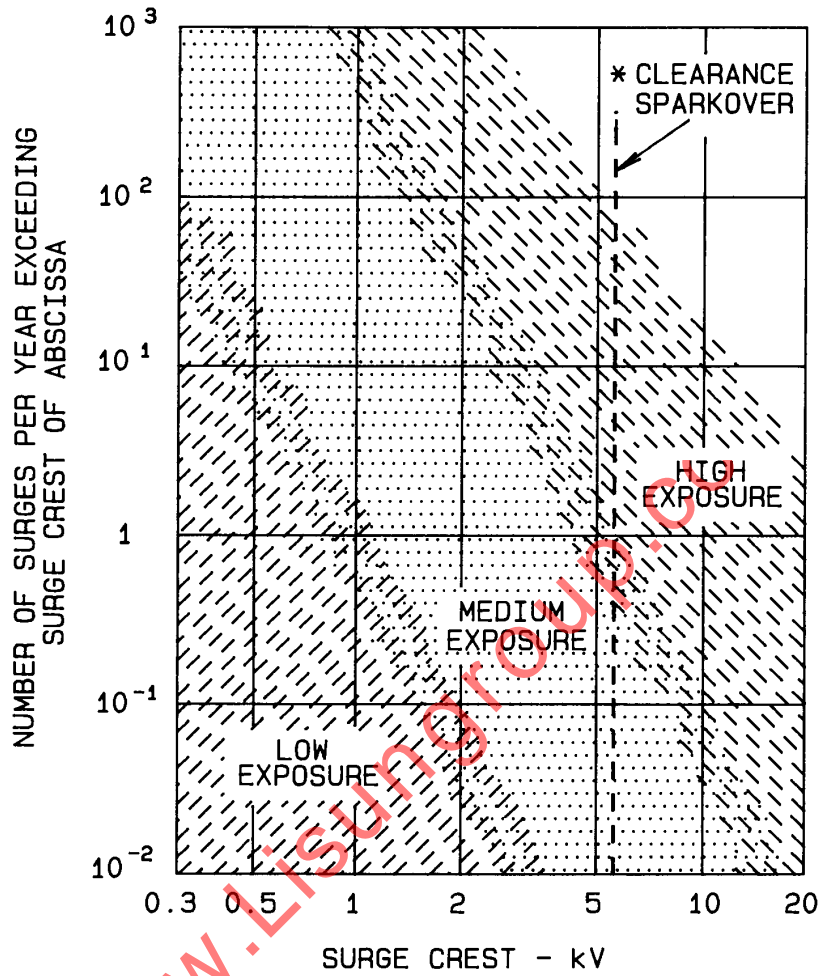

NOTES: (1) In some locations, sparkover of clearances may limit the overvoltages.  
 (2) This figure shows one measure of surge severity. Other possible measures include peak current, rise time, and energy transfer.

**Fig 6**  
**Rate of Surge Occurrences Versus Voltage Level at Unprotected Locations**

surges are influenced by isokeraunic levels (Figs 7 and 8) and flash densities.<sup>9</sup> The nature of the power distribution system (overhead open lines, overhead twisted lines, cables) and grounding practices will also influence the level of these surges.

The frequency of occurrence and level of power-system switching surges depend on the mode of operation of the utility supplying the user. For instance, the presence of switched capacitor banks is likely to affect the level of surges impinging at the service entrance.

The frequency of occurrence and level of load-switching surges depend on the nature and impedance of the adjacent loads being switched, as well as their electrical distance (see *surge impedance and source impedance* in Appendix B19) from the point of interest, rather than the geographic situation or the utility practice.

Thus, the exposure levels shown in Fig 6 cover a wide range of situations and represent relative rather than absolute levels. The sparkover of wiring devices indicates that while a 6 kV withstand capability may be enough to ensure device survival indoors, a withstand capability of 10 kV or greater may be required outdoors. This practical approach has been applied in proposing the matrix of levels in Section 9 for standard waveforms and in Section 10 for additional waveforms.

#### 7.4 Recommended Waveforms

**7.4.1 General.** Progress has been made in techniques for the recording of surges since the 1960s; the greater availability and improvements of waveform-recording instruments will further enhance the data base in the future. At the present time, however, the wide variety of events reported in the data base may be simplified into three types of surges. These three types will be described in detail in the following subsections; briefly, they are categorized as follows:

- (1) Oscillatory surges of relatively high frequency, generally labeled "Ring Wave." Those at the higher end of the frequency range have limited energy deposition capability, but may have high peak voltages. Those at the lower end of

the frequency range may have higher energy deposition capability but lower peak voltages.

- (2) High-energy surges of various waveforms generally accepted as representing appropriate stress levels associated with nearby direct lightning discharges, fuse operation, or capacitor switching.
- (3) Bursts of very fast surges, associated with local load switching, with little energy but capable of producing serious interference or upset.

In this section, a qualitative description and justification is presented for these three types of surges. Section 8 provides recommendations on the planning for surge immunity; Sections 9 and 10 provide precise numerical definitions and waveforms intended for planning surge tests or computer simulations of systems performance under surge conditions.

**7.4.2 Ring Waves.** Measurements in the field and in the laboratory indicate that most surge voltages propagating in indoor low-voltage systems have oscillatory waveforms (Martzloff and Hahn, 1970 [B22]; Allen and Segall, 1974 [B2]; Wernström et al., 1984 [B34]; Goedbloed, 1987 [B14]). A surge impinging on the system, even if initially unidirectional, excites the natural resonance frequencies of the system (Martzloff, 1990) [B48]. As a result, not only are the surges typically oscillatory, but surges may have different amplitudes and waveforms at different places in the system. The frequency of oscillation of these surges ranges from less than 1 kHz (primarily capacitor switching) to more than 500 kHz (primarily local oscillations).

Thus, more than one ring wave may be necessary to represent this type of surge. In the 1980 edition of this document, a "Ring Wave" was defined with a 0.5  $\mu$ s rise time and decaying oscillation at 100 kHz, each peak being 60% of the amplitude of the preceding peak of the opposite polarity. A ring wave with a lower frequency is also proposed as an additional waveform in Section 10.

The fast rate of change of the front of the ring wave can produce the effects associated with nonlinear voltage distribution in windings. Some semiconductors are also sensitive to  $dv/dt$  effects, in particular when they are

<sup>9</sup>See *expected occurrence of lightning* in Appendix B for a discussion of flash density and isokeraunic levels.



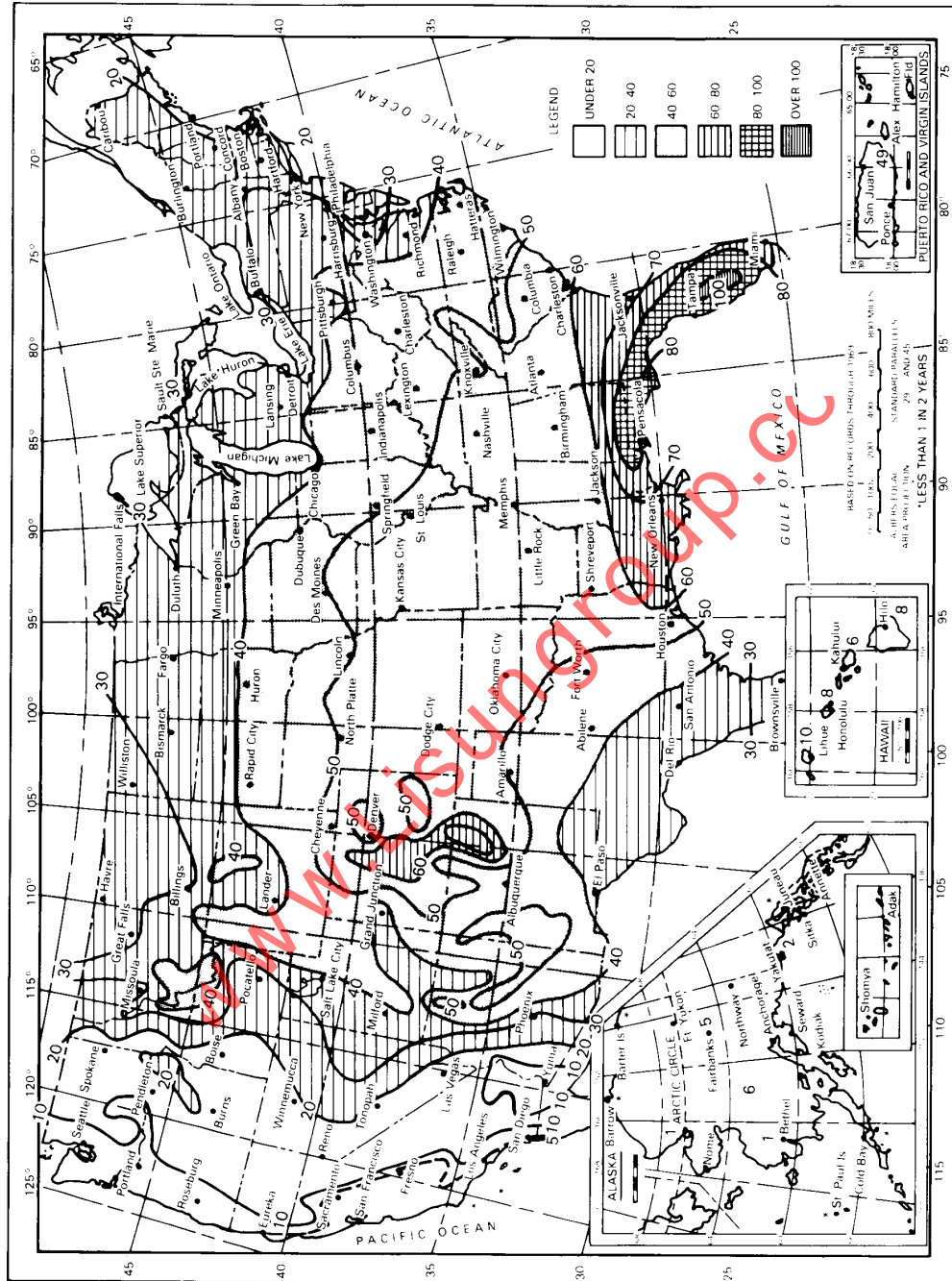
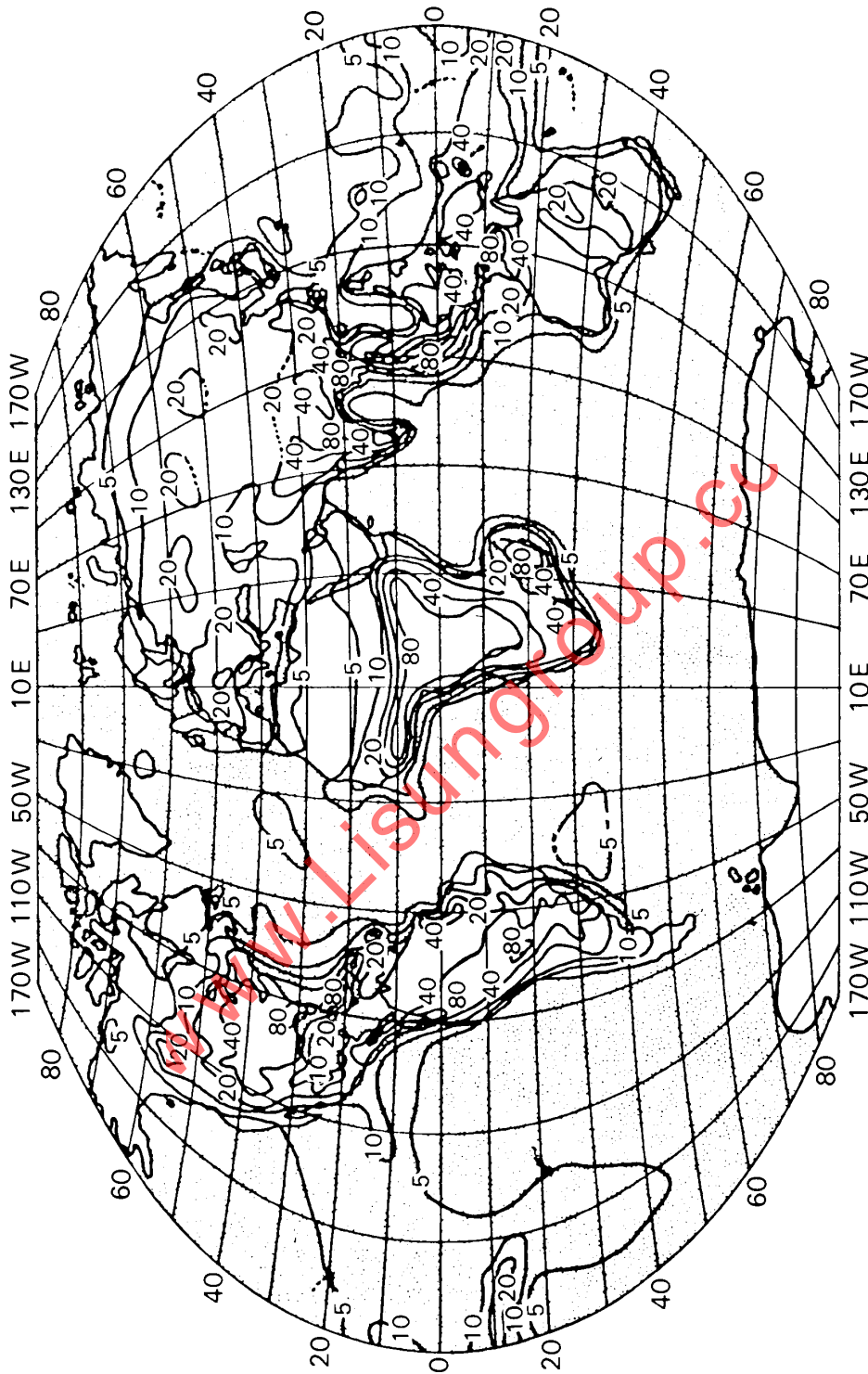

Fig 7  
Isokeraunic Levels for the United States



Source: Bodle et al. [B52]

**Fig 8**  
**Isokeraunic Levels for the World**

forced into or out of conducting states, or when a transient is applied during a particular portion of the power frequency supply cycle (see *timing of surges* in Appendix B22).

Shorter rise times are found in many transients, but as they propagate into the wiring or are reflected from discontinuities in the wiring, the rise times become longer (Martzloff and Leedy, 1990 [B46]; Martzloff, 1990 [B48]).

The peak voltage can produce insulation breakdown in connected components and equipment, even if the energy involved in the 100 kHz Ring Wave is small. Surges with higher energy deposition capability will be represented by other waveforms.

**7.4.3 High-Energy Surges.** Although the data base on energy is limited, there is a need to acknowledge the occurrence of high-energy surges capable of depositing more energy than that associated with the 100 kHz Ring Wave.

Anecdotal field experience shows that surge-protective devices with limited current handling capability installed at the service entrance have a significant failure history, while applications of the same device further inside a building are generally successful. From the energy and source impedance factors discussed under 7.5, it becomes apparent that the 100 kHz Ring Wave will not deposit enough energy in surge-protective devices to produce the observed failures.

Several types of events can be the origin of high-energy surges capable of delivering significantly more damaging energy:

- (1) Lightning surges on overhead distribution systems (A)
- (2) Lightning surges originating on overhead lines and traveling in cables (B)
- (3) Surges generated by fuse operation involving trapped energy in the power system inductance (C)
- (4) Surges generated by power-factor correction capacitor switching (D)

(A) Lightning surges on overhead lines have long been represented by a voltage surge of  $1.2/50 \mu\text{s}$  and a current surge of  $8/20 \mu\text{s}$  (IEEE C62.1-1984, [7]), which is described as "impulse" in IEC Document 99 [B97], and as the Combination Wave in the present document. These two waveforms have long been used, are readily generated in many laborato-

ries, and are an appropriate simplification of the environment near the service entrance of a building connected to an overhead distribution system. They also have substantial energy deposition capability, when applied from a generator with inherent capability to supply a voltage as well as a current waveform (IEEE C62.45-1987 [8]), to provide representative stress to connected equipment.

Because of the relatively short front time of  $8 \mu\text{s}$ , such a postulated current surge would not propagate very far into a building. The voltage drop associated with the propagation of a high-amplitude current surge front (thus high  $di/dt$ ) in the inductive impedance of the wiring would require a driving voltage at the service entrance high enough to cause sparkover of the clearances (Martzloff, 1983 [B43]). This limitation sets the basis of the selection of waveforms associated with the location categories discussed in 7.7 and makes their maximum amplitude less dependent on the system voltage than on the actual clearances.

(B) Lightning surges traveling in underground systems involve longer durations. Lightning surges that have traveled along a long cable have wave fronts with a slope less steep than that of the initiating wave, as a result of the propagation characteristics of the cable. The peak of the initiating surge is likely to reflect the operation of a surge arrester at the interface of the overhead system and the cable.

(C) Surges generated by fuse operation involving long cables are unidirectional surges lasting several hundred microseconds, depending on the inductance of the cable and the transformer feeding the fault being cleared by the fuse (Meissen, 1983 [B25]).

(D) Capacitor switching surges and some other switching surges involve damped oscillations at low frequency (a few hundred hertz to a few kilohertz) lasting for a few milliseconds at most (Boehne and Low, 1969 [B5]; Wiitanen et al., 1971 [B35]; Martzloff, 1986 [B22]). From the point of view of energy exchange, such a long oscillation could be simplified as the envelope of the oscillation. Such an envelope would have a duration in the same order of magnitude as the surges generated by fuse operation.

These last three types of surges, (B), (C), and (D), have maximum amplitudes reflecting the system voltage rather than clearances, in

contrast to the (A) surges. A simplified common representation might be adequate for these three phenomena.

For instance, the 10/1000  $\mu$ s unidirectional waveform has long been specified for surge protection requirements in the communications and process control industries (IEEE Std 518-1982, [10]), and a 100/1300  $\mu$ s waveform has been recommended in several IEC draft documents on electromagnetic compatibility. Thus, the present recommended practice added two additional waveforms of longer duration: a unidirectional surge (10/1000  $\mu$ s) and a low-frequency 5 kHz Ring Wave if the application warrants such waveforms.

It is not uncommon for the frequency of a capacitor switching surge to be much less than 5 kHz, as low as 300 Hz. The lower the frequency, the greater the available energy. This energy may be too great for a surge-protective device attempting to clamp that surge, particularly if the switching device should restrike during opening and little impedance exists between the switching device and the protective device.

The difficulty, however, is that the data base on these longer waveforms is limited concerning representative source impedances or available currents for these long-duration surges. Meaningful testing can be achieved only if source impedance or short-circuit current are defined in addition to a voltage waveform.

Therefore, at the present state of knowledge, this recommended practice can only urge designers and users to consider the specific application environment and call for additional waveforms if their knowledge of the environment justifies the added complication of testing for these additional waveforms.

In the absence of measurements on actual occurrences, some theoretical considerations on **surge impedance and source impedance** provide guidance on what the appropriate values may be for the source impedance or the available current.

For long waves in power-system cables, with travel times longer than the front time of the surge, the source impedance would be the characteristic impedance of the cable, typically 10  $\Omega$  to 100  $\Omega$  for power-system cables, as opposed to higher values for overhead open-wire lines. However, if the travel times are shorter than the front time of the surge, then the

inductive impedance would prevail, and its value may be as low as a fraction of an ohm at the lower frequencies implied by such long waves.

For surges generated by fuse operation, the maximum fault current involved in the trapped energy ( $1/2 Li^2$ ) has the value corresponding to the let-through current of the fuse in question (not the available fault current), as well as the system inductance, including the cable and the transformer feeding the fault. The let-through current is typically between 100 and 1000 A in residential or commercial circuits and possibly higher in industrial circuits.

For capacitor switching surges, the impedance of the complete circuit would be the combined impedance of the capacitor bank (source) and the series impedance between the point of switching and the point of interest (not the characteristic impedance). A few examples of this situation may be found in the literature.

**7.4.4 Fast Transients.** Circuit opening by air-gap switches (relays and contactors) has long been recognized as producing a succession of clearings and reignitions that generate bursts of fast-ringing surges in the circuits being switched (Mellitt, 1974 [B26]; Minegishi et al., 1989 [B27]). These transients have sometimes been associated with arcing phenomena under the label of "showering arc." Under the name of "Electrical Fast Transients (EFT)," IEC 801-4 (1988) [5] requires a test involving bursts of surges with 5 ns rise time and 50 ns duration at various severity levels.

The new version of surge withstand capability (SWC) tests (IEEE C37.90.1-1989 [6]), intended for protective relays and relay systems, also includes a fast transient specification. The waveform for the SWC test calls for a rise time of less than 10 ns and a duration of 150 ns, not very different from the 5 ns and 50 ns of the EFT. (The upset aspects are primarily associated with the rise time, so that the difference between a duration of 50 ns and 150 ns should not be a significant difference.)

Furthermore, the SWC test is primarily intended for the high-voltage substation environment, while the EFT test is intended for general industrial equipment. Therefore, this recommended practice encourages the use of the EFT test over the SWC test. Actually, when

tolerances are taken into consideration, differences in the effect of one waveform versus the other may not be very significant. Adopting the EFT waveform to represent the environment next to switching devices appears to be a reasonable choice of selection, in harmony with international standards, for equipment subjected to that environment.

In contrast to the other waveforms discussed previously, the duration of these fast transients is short compared to the travel time in building wiring systems (50 ns is the time required to travel 10 m). Therefore, transmission line concepts are applicable to describe the propagation of these transients in building wiring and large equipment. This fact has two implications in including these fast transients in the description of the surge environments:

- (1) The characteristic impedance of low-voltage wiring systems inside a building is typically 100  $\Omega$  to 300  $\Omega$  for L-N or L-L configurations, and typically 25  $\Omega$  to 75  $\Omega$  for LL-G or LN-G configurations (see Appendix B5 for a discussion of the terms *differential mode and common mode* in the context of this document). This impedance will limit the current associated with these fast transients.
- (2) After only a short distance traveling in the wiring, the amplitude, as well as the rate of rise, of these fast transients is attenuated (Martzloff and Wilson 1987 [B45]; Martzloff and Leedy, 1990 [B47]). Furthermore, even a small resistive or capacitive load at the end of the transmission line can reduce the arriving surge (Martzloff, 1990 [B48]). Thus, the design of the equipment and its method of connection to the mains, as well as the internal capacitance to ground, has a greater effect on the equipment withstand capability than changes in the waveform and amplitude of the impinging fast transients.

Therefore, fine detail in the specification of a fast transient waveform is not significant to the actual performance of the equipment; the only justification for a specific description of the waveform is the acknowledged need for uniformity in test procedures. The EFT seeks to emulate a phenomenon that occurs in

repeated groups of pulses that may vary in amplitude and duration over an indefinite period of time. It is not an attempt to reproduce the surges as they appear on the mains interface, as other surges waveforms do; it is a practical compromise for evaluating equipment immunity to fast transients.

This recommended practice emphasizes the importance of maintaining a clear distinction between the concepts of a *description* of a surge occurrence and a *test specification*. The preceding discussion of how the EFT test relates to the environment but is not to be taken as "representing" the environment is a good example of the need to maintain this distinction.

NOTE: Endorsing the EFT test procedure should not lead to the misinterpretation that there are such frequent and widespread fast transients with 4 kV peaks in low-voltage ac power circuits.

The only prevailing consideration is that passing the EFT test, when required for equipment acceptance, seems to result in improved equipment reliability. A good example for the need to consider fast transients is the case of two pieces of electronic equipment operating from the same receptacle, thus closely coupled. Disconnecting power from one while maintaining power to the other can subject the powered equipment to high-frequency transients such as the EFT (see *description versus specification* in Appendix B4).

Thus, a recommendation for considering the EFT as an additional waveform is directly related to a test demonstrating equipment immunity to upset by fast transients, rather than an inference that this specific waveform can be found in the environment. Fast transients do occur during contact arcing, and digital circuits are fast enough to respond (in an unwanted manner) to these fast transients. Detailed specifications on the test procedure are given in IEC 801-4 (1988) [5]. Waveforms are described in Sections 8 and 10; some implications of the test procedure are discussed under *EFT test* in Appendix B6.

**7.5 Amplitude, Energy, and Source Impedance.** For each waveform selected as one of the possible representations of the surge environment, the peak open-circuit voltage and the peak short-circuit current should be stated to provide a complete and meaningful description.



Occasionally, attempts will be made to describe surges in terms of "energy" to help select the rating of a candidate surge-protective device. However, this concept can be a misleading oversimplification because the energy distribution among the circuit elements involved in a surge event depends on the impedance of the source (including the ac mains) as well as on the impedance of the surge-protective device called upon to divert the surge (Standler, 1989 [B83]). There is no independent, meaningful, and self-contained description of a surge in terms of energy alone. The energy delivered to the end-equipment is the significant factor, but it depends on the distribution between the source and the load (equipment or surge-diverting protective device, or both).

In a gap-type protective device, the low impedance of the arc after sparkover forces most of the surge energy to be dissipated elsewhere. In a clamping protective device, by its very nature, a substantial share of the surge energy is dissipated in the protective device. It is therefore essential to the effective use of suppression devices that a realistic assumption be made on the source impedance of the surge whose effects are to be evaluated or duplicated by tests.

Note that the voltage waveforms proposed in this section are intended to represent the waveform that a surge source would produce across an open circuit. The waveform will change when the source is connected to a finite impedance load, and the degree to which it is lower is a function of the source impedance (see *surge impedance and source impedance* in Appendix B).

The devices should be able to withstand the current injected through them by the surge source. A test generator of too high an impedance may not subject the device under test to sufficient stress, while a generator of too low an impedance may subject protective devices to unrealistically severe stress. A test voltage wave specified without reference to source impedance could imply zero source impedance—one capable of producing that voltage across any impedance, even a short circuit. That would imply an infinite surge current, clearly a situation as unrealistic as an excessively high generator impedance.

The amplitude of a surge, as recorded in site surveys, is often cited in volts and is a signifi-

cant parameter for high-impedance equipment exposed to the surge at that site. However, the voltage amplitude of a surge observed at a specific site is dependent on the interaction of the source and the load connected at that time, because the series impedance upstream from the point of observation and the shunt impedance downstream from the point of observation act as a voltage divider. Unfortunately, there is very little data on actual surge currents.

The capability of a surge event to deliver a surge current to a device connected in shunt across the line at a specific point of the installation is the significant concern for low-impedance equipment exposed to that surge event. The interaction of source, mains, and load is relevant to this issue because of the current-limiting action of the source and mains impedances. The effective resistance of surge-protective devices,  $V/I$ , is typically less than  $1 \Omega$ . The effective source impedance (defined as the ratio of open-circuit voltage and short-circuit current) is typically larger than that of the protective device, ranging from a few ohms to a few tens of ohms.

One approach to providing meaningful description of the surges is to cite an open-circuit voltage, applicable to high-impedance circuits, and a short-circuit current, applicable to low-impedance circuits, as discussed in 7.7.

**7.6 Rate of Voltage Change.** As indicated by the schematic representation of Fig 1, the rate of change of a transient voltage is a significant parameter for equipment susceptible to upset caused by the coupling of fast transients into logic circuits.

The available data base on this aspect of surges is still scant, but some recent surveys include this parameter in their results (Fig 5). The preceding discussion of the EFT test concept also gives perspective on the issue. Recommending consideration of this EFT test, when appropriate, will also focus on susceptibility to rate of change.

**7.7 Location Categories.** Because of the wide range of possible source impedances and the difficulty of selecting a specific value, three broad categories of circuit locations have been defined in this document. These categories represent the vast majority of locations, from those near the service entrance to those remote from it.

For surges impinging the building and originating in the utility supply, the source impedance may be considered constant, while the series impedance of the mains increases from the outside to locations well within the building. Open-circuit voltages (load impedance of high values) for surges other than the fast transients show little variation within a building because simple wiring provides little attenuation (Martzloff, 1990 [B48]).

The increasing mains impedance between the service entrance and the point of connection to a piece of equipment will have an effect on the surge current. This impedance places a limit on the maximum rate of current change that can occur in the wiring because rapid changes of current require a driving voltage that would result in wiring sparkover at the source, thus cutting off the surge before it can travel further into the building.

Fig 9 illustrates the application of three location categories to the wiring of a power system. These three location categories may appear similar to three of the four overvoltage categories defined in IEC 664 (1980) [4]. However, the categories of IEC 664 (1980) [4] are voltage categories, while the location categories defined here are impedance (or current) categories. (See *installation categories* in Appendix B10 for the differences and similarities of the voltage and current staircases according to the two concepts.)

Location Category C is likely to be exposed to substantially higher voltages than Location Category B because the limiting sparkover occurs at higher values. In particular, the limiting effect of spark gaps or other clamps that might exist in the watt-hour meter or further downstream is not available in Location Category C. The high-exposure rates of Fig 6 could apply, with open-circuit voltages in excess of 10 kV and discharge currents of 10 kA or more. Field experience provides some information: secondary arresters having a 10 kA, 4/10  $\mu$ s rating (Section 8.6.1 of IEEE C62.1-1984 [7]) have been applied for many years in Location Category C and have demonstrated their capability for effectively diverting most surge currents associated with that environment. This observation provides a reasonable upper boundary to the levels of surges expected in typical Location Category C environments. Of course, direct lightning strikes at the point of interest would produce larger voltages and

currents (Cianos and Pierce, 1972 [B9]; Martzloff, 1980 [B42]; Chowdhuri, 1989 [B8]).

In the tables of Sections 9 and 10, three Location Categories, A, B, and C, are considered. Although a Location Category C device could be used in place of Location Category A or B devices, this is generally not necessary. The majority of applications involve indoor environments downstream from a service entrance connection, remote from the stress levels involved in Location Category C. Thus, the description of the Location Category C environment should not be indiscriminately turned into a required performance specification for all equipment, just for the sake of conservative design. For a given exposure level, voltages are the same in Location Categories A and B; only the current levels change, decreasing from Location Category B to Location Category A.

## 8. Recommended Planning for Surge Immunity

**8.1 General.** This section presents recommendations on steps to be taken to achieve surge immunity for equipment connected to low-voltage ac power circuits (mains). This approach implies recognition of the relation of equipment susceptibility, environment hostility, and degree of reliability required for the equipment.

The typical waveforms discussed in Section 7 will be used as specific recommendations for a representation of the basic environment with two standard waveforms (Section 9) and three additional waveforms (Section 10).

It should be noted that recommendation of test waveforms alone is not an equipment performance specification. Other documents, based on the waveforms recommended herein, have been or will be developed to describe the performance of equipment or protective devices in low-voltage ac power circuits. Test procedures for the standard waveforms are described in detail in IEEE C62.45-1987 [8].

**8.2 Reconciling Equipment Susceptibility and Environment Hostility.** Survival or undisturbed operation of equipment in the surge environment that has been described (and simplified) in Section 7 presents a technical as

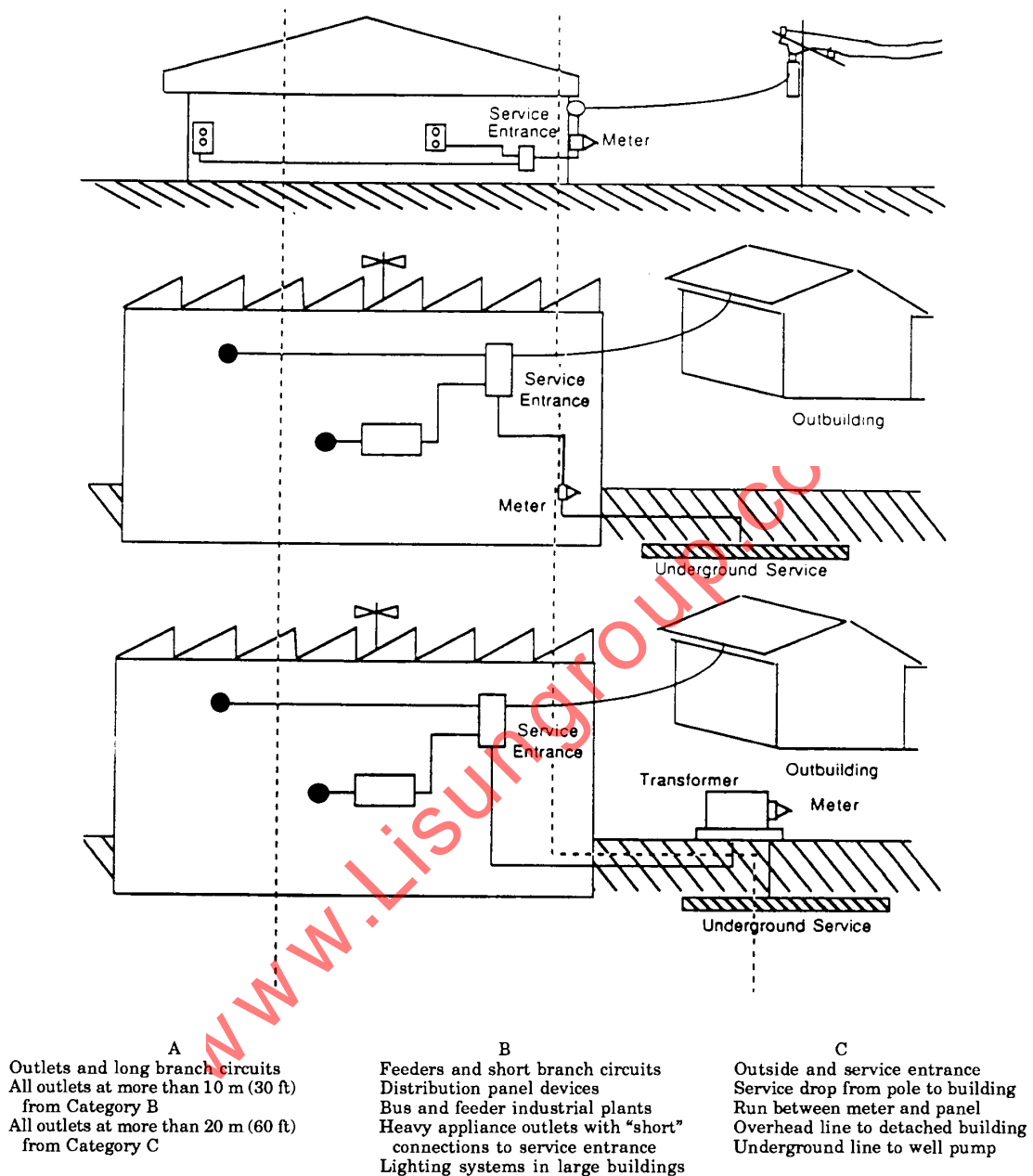

Demarcation between Location Categories B and C is arbitrarily taken to be at the meter or at the mains disconnect (ANSI/NFPA 70-1990 [2], Article 230-70) for low-voltage service, or at the secondary of the service transformer if the service is provided to the user at a higher voltage.

**Fig 9**  
**Location Categories**



well as an economic challenge. An approach that would attempt to provide sufficient surge withstand capability of all equipment for the worst possible environment may be uneconomical and perhaps not technically feasible.

Depending on the operational requirements of the equipment on the one hand, and the type of environment in which the equipment will be used on the other hand, a designer can make an effective protection match. Two steps are necessary in achieving the match. The first step is to recognize the type of environment in which the equipment will be installed. The next step is to select the appropriate characteristics for the interface: surge-protection levels matched to the needs of the equipment, and surge handling capability matched to the severity of the environment.

Immunity of equipment against surges impinging on the mains interface can be economically achieved by designing the equipment on the basis of a realistic description of the surge environment. The design activity includes coordination of the inherent surge withstand capability of the internal circuit components of the equipment, as required by the equipment function, with the surge response voltage of any front-end protective devices, with all of this done for a set of specific environments.

For very simple systems, it may be sufficient to compare the performance of the protective device to the withstand capability of the functional component. For more complex or nonlinear systems, and for surge-protective circuits, testing is always necessary. The behavior of nonlinear circuits is difficult to predict, and their interaction with surges on the one hand and complex electronic equipment on the other hand is even more so. Consequently, verification by test is unavoidable. To assist in this process, Sections 9 and 10 provide precise definitions (waveforms, tolerances, equations for modeling) of the various representative waveforms that have been identified in Section 7.

**8.3 Worst-Case Design and Economic Trade-Off.** Surge testing on the mains interface of equipment is generally performed to determine the surge withstand capability of the equipment that will be exposed to the surge environment expected at that interface. From the wide variety of field experiences described

in Section 6, representative waveforms have been recommended in Section 7 in order to reduce the test program to a manageable number of test requirements.

Excessively conservative planning will drive the requirements toward specifying the largest number of possible types of surge waveforms and the highest levels of stress, presumably to achieve maximum reliability of the equipment. Such overdesign of equipment surge protection may result in poor economy and a false sense of security.

Specifying only the maximum stress in a test program based on the most severe environment level specification may not provide complete protection and should be avoided for two reasons:

- (1) Failure may occur at levels lower than that of a single test at maximum stress, therefore incomplete information would be obtained on the level at which failures start occurring.
- (2) Worst yet, blind spots may exist in the performance of the equipment, where the test outcome is a success at the highest stress level, but a lower stress level would produce a failure or upset. There is a tendency to believe that more current or voltage will produce the more devastating results. This is not necessarily true. Frequently, a high-energy surge can cause a protective device to react more quickly than a low-energy surge.

In general, a trade-off based on risk analysis is an inescapable element of equipment design and specification. Furthermore, the level of immunity of any specific equipment within a particular design (catalog number and vintage) is not a single-value parameter, but is represented by some statistical distribution. In addition, the amplitude of the surges that can be expected on the mains is also a statistical distribution. Therefore, reconciling the equipment susceptibility with the surge environment level involves the probabilistic intersection of two distributions, as illustrated by Fig 10.

The range of electromagnetic environments in which a particular piece of equipment will be called to operate can vary widely. Some equipment is intended for a specific environ-

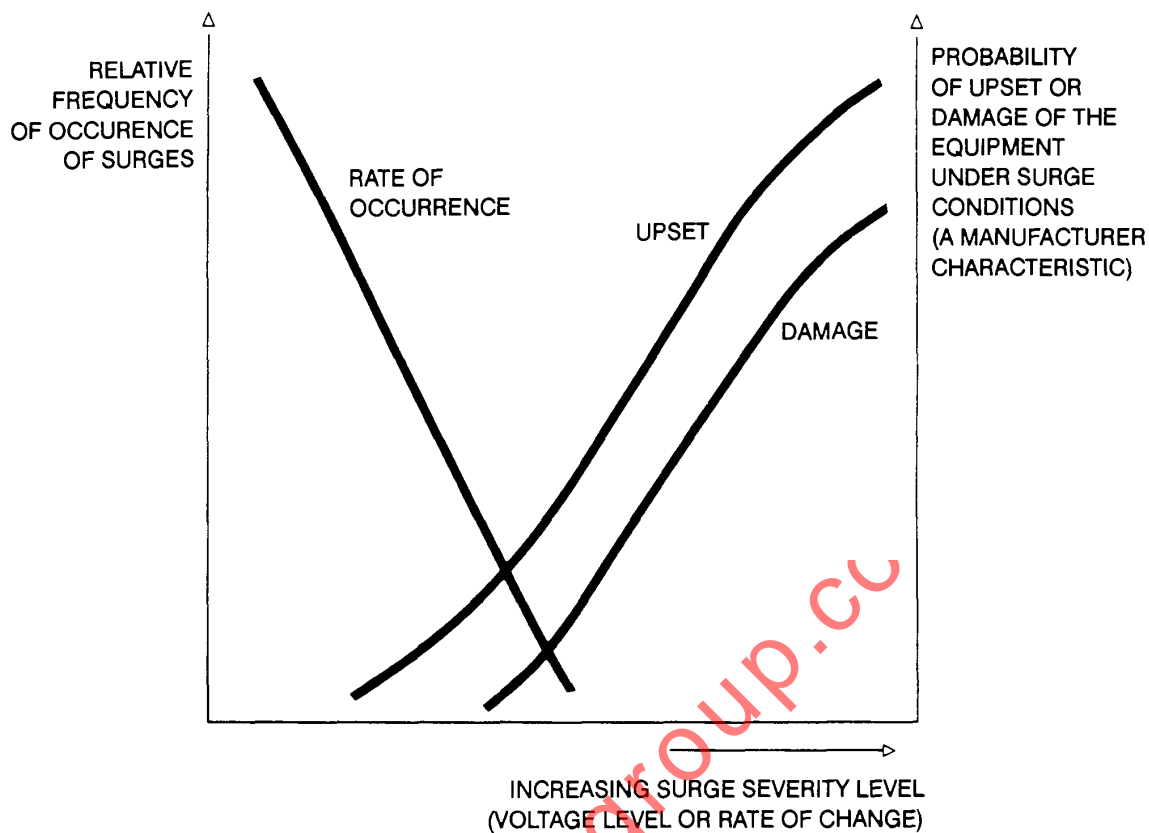

Fig 10  
Concept of Surge Immunity

ment while other equipment can be applied in a variety of environments. In addition, the particular environment may in fact change over time, as a function of a number of factors, including geographic, seasonal, and annual changes in local lightning incidence. Another change over time concerns the existing complement of nearby electric and electronic equipment that may generate interfering or damaging surges.

For industrial equipment, industry groups and various standardizing bodies often provide guidance in the selection of EMI severity levels that the equipment has to endure, of which the surge environment discussed here is a subset. In both areas of commercial and consumer goods, however, manufacturers often make their own trade-offs between excessive malfunctions or damage on the one hand and excessive costs on the other. One

solution to this ongoing dilemma is to design products whose basic surge immunity is coordinated with low or medium exposure levels, while offering options, upgrades, or additional protection for more hostile environments.

Independent of the immunity level built in or supplied optionally to provide performance without upset or damage, protection of some kind is often included to guard against so-called consequential damage, such as fires or explosions, while nevertheless allowing the victim equipment itself to fail.

It is to assist making evaluations among these and other alternatives, for equipment of all types, that this section on planning for surge immunity has been prepared.

**8.4 Surge Effects.** The nature and functional purpose of the equipment influence the judgment of what will be considered an acceptable

or unacceptable effect of a surge. When the consequences of a failure are not safety related but only represent an economic loss, it may be appropriate to trade off the cost of protection against the likelihood of a failure caused by a high-energy, but rarely encountered, surge. This rarity can take two different aspects "when?", or "where?"

- During operation of the vast majority of equipment in service, surges with relatively high levels of voltage or current can occur on rare occasions, such as that caused by lightning or multiple restrikes during de-energization of capacitor banks—the question is when?
- Among all equipment in service, a few rare installation sites are frequently and consistently afflicted by surges like local switching surges, for instance, power-factor correction capacitor banks—the question is where?

The consequences of a surge impinging on the mains interface can be classified in four broad categories, as discussed in the following list, each having several aspects.

- (1) *No observed change*. This absence of visible change would demonstrate that the equipment is actually immune to the surge level in question; however, appearances can be deceiving. The equipment can continue normal performance within specified limits, thus meeting the criterion of "No loss of function or performance." Yet significant consequences are possible: degradation of performance still within limits but foreboding larger degradation, latent failure of a component, or an unforeseen consequence elsewhere in the equipment environment (IEEE C62.45-1987 [8]).
- (2) *Upset*. This consequence can be a self-recoverable upset by design of the software and therefore not immediately apparent, or may be a permanent upset requiring operator intervention or programmed automatic action occurring after some time delay. Many documents on test methods suggest three classes for this type of consequence, as follows:

- (a) Minor: Acceptable temporary loss of function, but no faulty operation.
- (b) Major: Temporary faulty operation or performance (which is self-recoverable)
- (c) Critical: Faulty operation or performance that requires operator intervention or system reset. Another consequence that may be classified in this category is an upset caused by sparkover of air clearances without permanent degradation of adjacent solid insulation.

(3) *Damage*. This consequence includes the subtle as well as the obvious. As discussed under (1) above, damage may occur without being detected unless special assessment of the equipment condition is performed. One of the most vexing problems in insulation testing is the risk of creating an incipient defect by applying a surge test.

(4) *Consequential Damage*. This consequence includes the possibility that equipment subjected to a surge may cause damage to its surroundings well beyond the importance of the damage or upset done to the equipment itself. Ignition of a fire or an explosion could occur. Damage may result from unseen hardware upset, during which data become corrupted data that may subtly degrade other elements in the data base, with the user left unaware of the situation.

Criteria for acceptance or rejection have to take into consideration these different consequences. For instance, upset may be ruled out until a specified level of severity is reached, above which occurrence of an upset is declared acceptable; at some higher severity level, damage may be ruled acceptable, provided that safety not be jeopardized and no consequential damage occurs. In any event, it is imperative that data validity, where applicable, be verified following each test to ensure that data base damage has not occurred.

Furthermore, the level at which an upset or damage occurs depends on the mission of the equipment. For this reason, universal levels of withstand should not be assigned to all equipment. Hence, the values of *environment levels* proposed in the next sections should not

be blindly construed as test severity levels requirements.

**8.5 Selection of Waveforms.** Five types of surge waveforms are described in general terms in 7.4. Two of these are recommended as standard waveforms and three as additional waveforms. Table 2 presents a summary of these waveforms, showing in which Location Categories they are applicable. Further information on the standard waveforms is presented in Section 9, and on the additional waveforms in Section 10. These two sections provide precise definitions, including tolerances on the performance of test equipment and equations for the nominal waveforms. The tolerances are intended to help assure reproducible waveforms among different laboratories and to provide a realistic perspective on the limitations of generation and measurement of test surges. The equations are intended for computer simulations of surge protection circuits and for design of surge generators. The history of the definitions of

these waveforms is discussed in Standler, 1989 [B68].

NOTE: The fact that five waveforms are listed in this document should not be construed as a requirement that all equipment be subjected to all five types of surges. The 100 kHz Ring Wave and the Combination Wave are recommended as basic design and test surges. The additional waveforms (the EFT, the 10/1000  $\mu$ s Wave, and the 5 kHz Ring Wave) need only be included when sufficient evidence is available to warrant their use.

In this manner, a transition is made between the *description* of the surge environment, which was the first objective stated in the scope of this recommended practice, and the *recommendation* of specific test waveforms, which is the second objective. The *amplitude* of the test surges is still a characteristic selected by the parties involved, taking into consideration the environment exposures listed in the tables of Sections 9 and 10. In the selection of these levels, the concept of Transient Control Level (Fisher and Martzloff, 1976 [B53]) could provide guidance on the determination of the design margins and test procedures.

**Table 2**  
**Summary of Applicable Standard\* and Additional Waveforms<sup>‡</sup>**  
**for Location Categories A, B, and C**

Location Category (3)	100 kHz Ring Wave (Table 3)	Combination Wave (Table 4)	5/50 ns EFT Burst (Table 7)	10/1000 $\mu$ s Wave (Table 8)	5 kHz Ring Wave (Table 9)
A	Standard	None	Additional	Additional	Additional
B	Standard	Standard	Additional	Additional	Additional
C	None	Standard	None	Additional	Additional

\* Refer to Tables 3, 4, and 5 for details on the standard waveforms (Section 9).  
<sup>‡</sup> Refer to Tables 7, 8, and 9 for details on the additional waveforms (Section 10).

The 1980 edition of this document, as a guide, provided some schematic diagrams of pulse-shaping networks for surge generators that provided the three waveforms specified in that edition.

Experience has shown that improvised surge generators, while they can produce stresses useful for in-house immunity evaluation (Buschke, 1988 [B71]), can also produce waveforms that may not be easily reproduced in other laboratories. The output waveforms of generators built from a published circuit are often dominated by parasitic components and do not produce the desired waveforms. Improvised generators may also lack critical safety

features. Therefore, this revised document provides precise information on desired waveforms, but no longer provides descriptions of circuits for surge generators.

## 9. Definition of Standard Surge-Testing Waveforms

**9.1 General.** The two recommended standard waveforms are the 100 kHz Ring Wave and the 1.2/50  $\mu$ s–8/20  $\mu$ s Combination Wave. The parameters of these two standard waveforms are summarized in 9.1.1 and 9.1.2. Plots of the

three nominal waveforms (one for the Ring Wave, two for the Combination Wave) are shown in Figs 11–13. Criteria for selection of the peak voltages and currents that correspond to various environmental exposures are discussed in 9.2 with reference to Tables 3, 4, and 5. The implications for test conditions are discussed in 9.3. A detailed description, including tolerances, of these two standard waveforms is given in 9.4. Equations describing the waveforms are given in 9.5.

**9.1.1 100 kHz Ring Wave.** A plot of the nominal Ring Wave is shown in Fig 11, and further details are given in 9.4.1. No short-circuit current waveform is specified for the 100 kHz Ring Wave. A peak short-circuit current, however, is proposed in 9.2, according to the location category. The nominal ratio of peak open-circuit voltage to peak short-circuit current (effective impedance) is specified to be  $12 \Omega$  for simulation of Location Category B environments or  $30 \Omega$  for simulation of Location Category A environments. The nominal amplitude of the first peak of either the open-circuit voltage or the short-circuit current is selected by the parties involved (see 9.2), according to the severity desired.

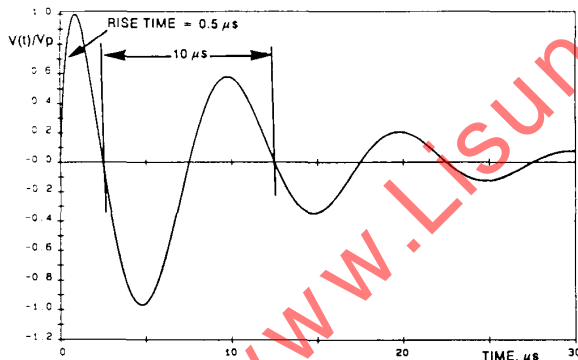
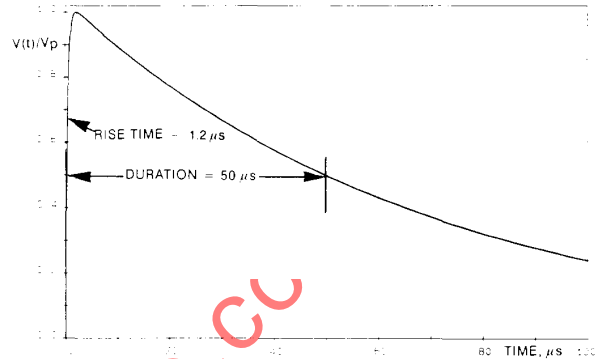

**Fig 11**  
100 kHz Ring Wave

**9.1.2 Combination Wave.** The Combination Wave involves two waveforms, an open-circuit voltage and a short-circuit current, shown in Figs 12 and 13 respectively. Further details are given in 9.4.2. The Combination Wave is delivered by a generator that applies a  $1.2/50 \mu\text{s}$  voltage wave across an open circuit and an  $8/20 \mu\text{s}$  current wave into a short cir-

cuit. The exact waveform that is delivered is determined by the generator and the impedance to which the surge is applied.

The value of either the peak open-circuit voltage or the peak short-circuit current is to be selected by the parties involved (see 9.2), according to the severity desired. The nominal ratio of peak open-circuit voltage to peak short-circuit current is  $2 \Omega$  for all severity levels.



**Fig 12**  
Combination Wave, Open-Circuit Voltage

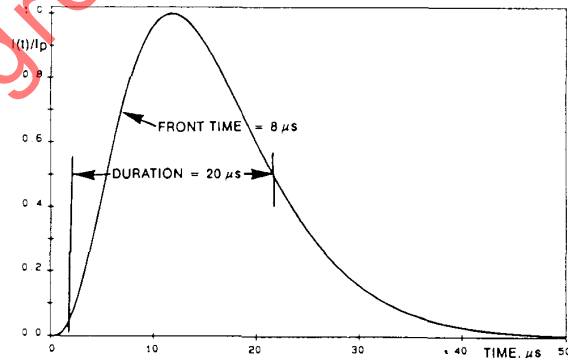

**Fig 13**  
Combination Wave, Short-Circuit Current

**9.2 Selection of Peak Values of Standard Waveforms.** Tables 3, 4, and 5 include a multilevel matrix of location categories, types of surges, and peak voltages and currents provided as a guide toward the selection of an appropriate set of design parameters or tests. It is emphasized that Tables 3, 4, and 5 can only provide a menu. *They are not intended to be mandatory requirements.*

**Table 3**  
**Standard 0.5  $\mu$ s–100 kHz Ring Wave**  
**Voltages and Current Surges Expected in Location Categories\* A and B†**  
**Low, Medium, and High Exposures‡**  
**Single-Phase Modes:§ L-N, L-G, and [L&N]-G**  
**Polyphase Modes: L-L, L-G, and [L's]-G**  
**(See Table 5 for N-G Mode)**

Location Category*	System Exposure †	Peak Values **		Effective Impedance ( $\Omega$ )††
		Voltage (kV)	Current (kA)	
A1	Low	2	0.07	30
A2	Medium	4	0.13	30
A3	High	6	0.2	30
B1	Low	2	0.17	12
B2	Medium	4	0.33	12
B3	High	6	0.5	12

\* See 7.7 for definition and discussion of Location Categories.

† No provision is made for a 100 kHz Ring Wave in Category C.

‡ See 7.3.3 for definition and discussion of system exposure.

§ See IEEE C62.45-1987 [8] for discussion of coupling modes.

\*\* The three values shown for each location category, for the three system exposures within the location category, have been set by consensus to provide guidance and uniformity in test procedures. Other levels may be negotiated between the parties involved.

In making simulation tests, use the voltage values shown for the open-circuit voltage of the test generator or the current values shown for the short-circuit current of the test generator (with coupling network and back filter in place).

†† The effective impedance of the surge source, emulated by the test generator, is defined as the ratio of the peak voltage to the peak current. It has the dimension of a resistance, but is not a pure resistance (see 9.4.1).

**Table 4**  
**Standard 1.2/50  $\mu$ s–8/20  $\mu$ s Combination Wave**  
**Voltages and Current Surges Expected in Location Categories\* B and C†**  
**Low, Medium, and High Exposures‡**  
**Single-Phase Modes:§ L-N, L-G, and [L&N]-G**  
**Polyphase Modes: L-L, L-N, L-G, and [L's]-G**  
**(See Table 5 for N-G Mode)**

Location Category*	System Exposure †	Peak Values **		Effective Impedance ( $\Omega$ )††
		Voltage (kV)	Current (kA)	
B1	Low	2	1	2
B2	Medium	4	2	2
B3	High	6	3	2
C1	Low	6	3	2
C2	Medium	10	5	2
C3	High	20	10	2

\* See 7.7 for definition and discussion of Location Categories.

† No provision is made for a Combination Wave in Category A; however, equipment connected to short branch circuits may be exposed to a moderate level of Combination Wave surges (UL 1449-1988 [B96]).

‡ See 7.3.3 for definition and discussion of system exposure.

§ See IEEE C62.45-1987 [8] for discussion of coupling modes.

\*\* The three values shown for each location category, for the three system exposures within the location category, have been set by consensus to provide guidance and uniformity in test procedures. Other levels may be negotiated between the parties involved.

In making simulation tests, use the voltage values shown for the open-circuit voltage of the test generator or the current values shown for the short-circuit current of the test generator (with coupling network and back filter in place).

†† The effective impedance of the surge source, emulated by the test generator, is defined as the ratio of the peak voltage to the peak current. It has the dimension of a resistance, but is not a pure resistance (see 9.4.2).



**Table 5**  
**Neutral-Ground Mode**

**Standard Representative Waveforms and Levels for Maximum Voltage and Current Surges Inside Buildings for N-G Mode, Depending on Applicable Neutral Earthing or Bonding Practice\*†‡**

Neutral Grounding Practice	Distance From Entrance or Surge Source	System Exposure§	Applicable Surge			
			0.5 μs–100 kHz		1.2/50 μs–8/20 μs	
			Peak Voltage (kV)	Effective Impedance (Ω)**	Peak Voltage (kV)	Effective Impedance (Ω)**
Neutral earthed at service entrance	Close	All	None	None	None	None
	Nearby	All	<i>1</i>	<i>30</i>	None	None
	Far	All	<i>3</i>	<i>30</i>	None	None
Neutral not earthed at service entrance	All	Low	<i>2</i>	<i>12</i>	<i>2</i>	<i>2</i>
	All	Medium	<i>4</i>	<i>12</i>	<i>4</i>	<i>2</i>
	All	High	<i>6</i>	<i>12</i>	<i>6</i>	<i>2</i>

\*The values for peak voltage and effective impedance have been set in italic type to emphasize that there is no data base to support these values. Instead, these numbers and waveforms have been selected by consensus to provide uniformity in test procedures. These values are not intended to be mandatory requirements.

†Bonding the neutral to the equipment grounding conductor (protective earth) and to the building ground at the service entrance, or at a separately derived ac power source, effectively prevents the propagation of external surges in N-G mode. This situation, including that of the separately derived ac power source, corresponds to the requirement of ANSI/NFPA 70-1990 [2]. In such installations, N-G surges may still be generated by internal load switching or by mode conversion when surge currents flow in the inductance of the neutral or grounding conductors, or both (see *differential mode and common mode* in Appendix B5). The 100 kHz Ring Wave is an appropriate representation of inductive voltages in the wiring.

‡When the neutral is not bonded to the equipment grounding conductor (protective earth) nor to the building ground at the service entrance, N-G surges can be expected in a manner similar to those defined for the L-L, L-N, or L-G modes, as shown in Tables 3 and 4. This more severe situation will be encountered in installations not subject to ANSI/NFPA 70-1990 [2]. It is standard practice in some European countries (see *differential mode and common mode* in Appendix B5).

§See 7.3.3 for definition and discussion of system exposure.

\*\*The effective impedance of the surge source, emulated by the test generator, is defined as the ratio of the peak voltage to the peak current. It has the dimension of a resistance, but is not a pure resistance.

The recommendations of the present document address the need to make a deliberate choice, but leave the choice to the parties interested in the issues, who are presumed to have the best available knowledge of the particular situation. Because the system exposure levels may be different with respect to the source of the surges and hence the waveform, separate tables are provided for the Ring Wave and for the Combination Wave. For instance, an installation may be located in an area of high lightning activity but little switching activity (giving more weight to the Combination Wave), or vice versa.

Making such a choice, however, may be difficult. On the one hand, the nature and mission of the equipment have a strong influence on the choice. Some equipment is likely to be operated in a well-defined environment exposure and location category; others may be operated in a broad variety of exposures and

location categories. Furthermore, the consequence of a failure, and thus the selection of a degree of margin, are related to the mission of the equipment.

On the other hand, when dealing with mass-produced equipment, it would be impractical or unrealistic to tailor the equipment surge withstand specifications to a specific environment exposure and location category. In such cases, a selection must be made to cover the typical situation, not the extreme—unless life-support or similar stringent requirements mandate a conservative design.

**9.3 Test Conditions**

**9.3.1 Powered Testing.** During powered testing of equipment that is connected to the mains, it is necessary to interpose a back filter between the Equipment Under Test (EUT) and the mains and to use a coupling network between the surge generator and the EUT, as



described in IEEE C62.45-1987 [8]. The presence of the back filter and the coupling network, and the low impedance of the mains will alter the surge wave shape compared to that observed at the output terminals of the surge generator alone (Richman, 1985 [B78]).

When the intent of surge testing is to apply surges to the mains connection of the EUT while the equipment is operating, the effect of the back filter and the coupling network on the surge waveform have to be included when determining the surge wave shape. That is, the expression "open-circuit voltage" means that the EUT is not connected, but the surge coupler and back filter have to be. They are clearly parts of the surge generator, since they may affect the wave applied to the EUT.

**9.3.2 Verification of the Test Generator.** As a result of these effects, it is necessary that the surge waveform specifications for both the 0.5  $\mu$ s–100 kHz Ring Wave and the 1.2/50  $\mu$ s–8/20  $\mu$ s Combination Wave be satisfied accordingly. An initial verification should be made of the following conditions:

- (1) The surge generator is connected to the back filter via the coupling network in the relevant coupling mode, and
- (2) All of the conductors of the mains connection that supply the back filter, including protective ground, are disconnected from the mains and shorted together at a point upstream from the back filter.

By shorting the mains upstream from the back filter (prior to the actual powered test), the effects caused by differing impedances of the mains from one laboratory to another are avoided. Allowing the ac supply mains to be disconnected and simulating the low impedance of the mains by shorting the conductors together is the recommended procedure to determine peak voltage and current. The available short-circuit surge current and the open-circuit surge voltage (as defined above) at the EUT power line interface can be readily verified. Note, however, that this procedure establishes the voltage peak of the surge alone.

During testing of powered equipment or components, the surge waveform may be applied at any specified phase angle of the normal mains waveform, as described in IEEE C62.45-1987 [8]. The timing of the surge appli-

cation with respect to the power-frequency sine wave will then determine the peak of the total surge. Because this total surge is the significant parameter in the response and stress of a clamping type of surge-protective device, this effect must be recognized in setting the surge amplitudes for low-level surge testing. With surge levels in the kilovolt range, the variation introduced by the value of the sine-wave voltage at the instant of the surge application is less significant.

In tests where the value of  $di/dt$  is large (such as the 8/20  $\mu$ s current waveform or the 100 kHz Ring Wave with its relatively short rise time), it is particularly important to use short lengths of conductors and maintain minimum conductor loop area between the surge generator and the device under test.

**9.3.3 Tolerances on the Most Important Parameter.** The combination of practical tolerances on the surge generator internal components, operator settings, and instrument calibration uncertainties may produce significant variations in the results of tests performed at different sites. To reduce the effect of these unavoidable differences, the purpose of the test should be recognized when specifying the most important test parameter:

- (1) When testing insulation, the peak open-circuit voltage is the most important parameter. Therefore, the voltage should be adjusted to the desired level before connecting the EUT to the generator.
- (2) When testing energy-absorbing non-linear surge-protective devices, the short-circuit current peak is the most important parameter. However, the current flowing in the EUT should NOT be adjusted during the test to obtain a desired level.

The reason for point (2) is that the test should be performed using a generator with specified open-circuit voltage and specified short-circuit current waveforms. For the specific EUT being subjected to the specific surge environment test, the peak values of both the EUT voltage and EUT current during the test should be allowed to remain whatever they are. This matter is often misunderstood and, therefore, it cannot be overemphasized.

**9.3.4 Unpowered Testing.** When the 1.2/50  $\mu$ s–8/20  $\mu$ s Combination Wave is used to

test unenergized components, the same generator, with back filter in place, may still be used. However, the mains should be disconnected upstream from the back filter and all of the input power conductors shorted together and to ground.

Alternatively, the back filter and the coupling network may be removed from a surge generator that has an internal circuit to determine the presence or absence of a back filter/coupling network and to make the appropriate adjustments in the waveform. Such circuits are included in many commercially available surge generators.

#### 9.4 Detailed Specifications of Waveforms

**9.4.1 0.5  $\mu$ s–100 kHz Ring Wave.** The open-circuit voltage waveform is defined by the following parameters:

Rise time: 0.5  $\mu$ s  $\pm$  0.15  $\mu$ s

Ring frequency: 100 kHz  $\pm$  20 kHz

The amplitude will decay so that the amplitude ratio of adjacent peaks of opposite polarity is as follows: the ratio of the second peak to the first peak is between 40 and 110%. The ratio of the third peak to the second peak and of the fourth peak to the third peak is between 40 and 80%. A plot of the nominal 100 kHz Ring Wave is shown in Fig 11.

The rise time is defined as the time difference between the 10% and 90% amplitude points on the leading edge of the waveform. The frequency is calculated from the first and third zero-crossing after the initial peak.

The nominal amplitude of the first peak of either the open-circuit voltage,  $V_p$ , or the short-circuit current,  $I_p$ , is to be selected by the parties involved (see 9.2), according to the severity desired, with a tolerance of  $\pm 10\%$ .

The ratio  $V_p/I_p$  is specified as  $12 \Omega \pm 3 \Omega$  for simulation of Location Category B environments or  $30 \Omega \pm 8 \Omega$  for simulation of Location Category A environments. When the peak open-circuit voltage is adjusted to be exactly 6 kV, the nominal peak short-circuit current will be 500 A for Location Category B environments and 200 A for Location Category A environments. For lower peak voltages, the peak short-circuit current will be proportionately lower, so that the nominal ratio  $V_p/I_p$  remains either  $12 \Omega$  or  $30 \Omega$ .

No short-circuit current waveform is specified for the 100 kHz Ring Wave. A peak short-

circuit current, however, is proposed in 9.2, according to the location category. Because the purpose of this Ring Wave is not to provide high-energy stress to the equipment under test, the precise specification of the current waveform is unnecessary.

The short 0.5  $\mu$ s rise time of the leading edge of the waveform, together with a large peak current, corresponds to a large value of  $dI/dt$ , which will produce significant inductive effects in the connections of the devices under test. The voltage divider action of the surge generator impedance and the EUT impedance is likely to be significant; it is addressed by specifying the peak short-circuit current.

The first edition of this document specified a nominal rate of decay of amplitude of 60% between adjacent peaks of opposite polarity, but no tolerances were specified. It is not possible to obtain the 60% ratio of amplitude of the second to the first peak while also obtaining the 60% ratio between subsequent peaks with a simple damped cosine waveform (Standler, 1988 [B84]). As a result, the wave shape of the first cycle of the Ring Wave varied dramatically among different models of commercially available surge generators (Standler, 1989 [B86]) because different circuit designs of the wave-shaping network were used in an attempt to meet the specifications for the nominal waveform. When tolerances were added to this document, large tolerances were applied to the ratio of the first and second peaks so that a cosine waveform with an exponentially decaying amplitude would meet the requirements for the Ring Wave. Although existing generators are acceptable, it is recommended that new designs for 100 kHz Ring Wave generators use the damped cosine waveform described in 9.5. A plot of the nominal damped cosine waveform is shown in Fig 11.

There is no requirement set on the amplitude of the Ring Wave beyond the fourth peak. The amplitude of the fifth and following peaks is so much smaller than the initial peak that they should have little effect on even the most vulnerable or susceptible equipment.

The frequency of oscillation of this waveform may excite resonances in the EUT. However, this effect cannot be positively identified with the fixed-frequency Ring Wave; a swept-frequency test would be necessary for that purpose.

**9.4.2 1.2/50–8/20  $\mu$ s Combination Wave.**  
The Combination Wave is delivered by a generator that can apply a 1.2/50  $\mu$ s voltage wave across an open circuit and an 8/20  $\mu$ s current wave into a short circuit. The exact waveform that is delivered is determined by the generator and the impedance to which the surge is applied. A plot of the nominal open-circuit voltage is shown in Fig 12 and a plot of the nominal short-circuit current is shown in Fig 13.

Open-circuit voltage waveform:  
Front time: 1.2  $\mu$ s  $\pm$  0.36  $\mu$ s  
Duration: 50  $\mu$ s  $\pm$  10  $\mu$ s

The front time for voltage waveforms is defined (IEC 60-2 (1973) [B92]; IEEE Std 4-1978 [B88]) as:

$$1.67 (t_{90} - t_{30}) \quad (\text{Eq 1})$$

where

$t_{90}$  and  $t_{30}$  = The times of the 90% and 30% amplitude points on the leading edge of the waveform

The duration is defined as the time between virtual origin and the time of the 50% point on the tail. The virtual origin is the point where a straight line between the 30% and 90% points on the leading edge of the waveform intersects the  $V = 0$  line.

Short-circuit current waveform:

Front time: 8  $\mu$ s (+1.0, -2.5)  $\mu$ s  
Duration: 20  $\mu$ s (+8, -4)  $\mu$ s

The front time for current waveforms is defined (IEC 60-2 (1973) [B92]; IEEE Std 4-1978 [B88]) as:

$$1.25 (t_{90} - t_{10}) \quad (\text{Eq 2})$$

where

$t_{90}$  and  $t_{10}$  = The times of the 90% and 10% amplitude points on the leading edge of the waveform

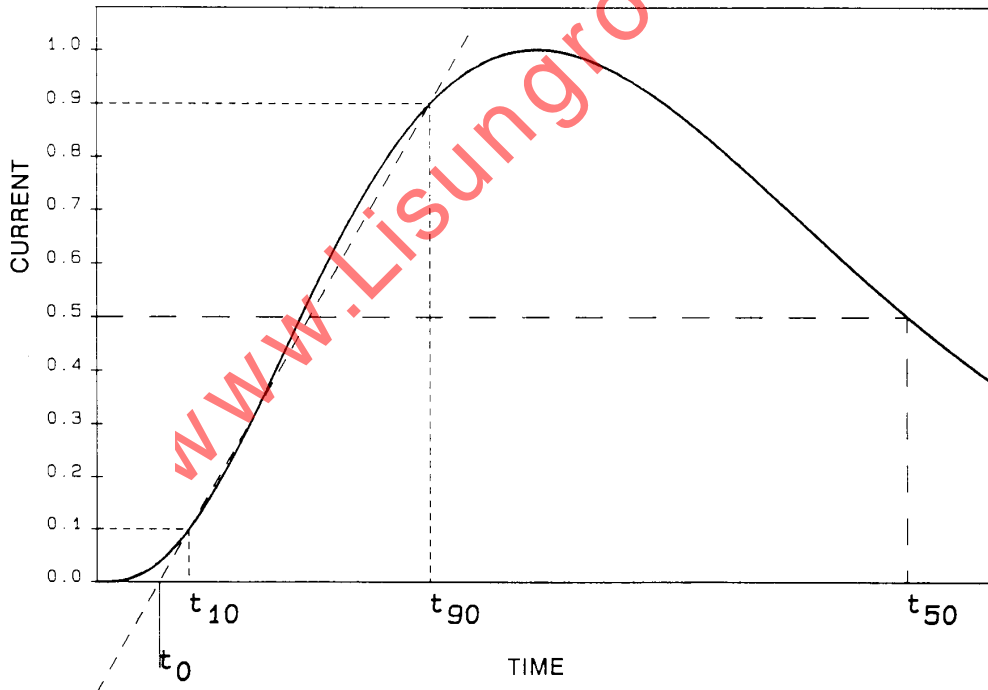

**Fig 14**  
**Features of the Nominal 8/20  $\mu$ s Waveform: Front Time, Virtual Origin, and Duration**

Duration is defined as the time between virtual origin and the time of the 50% amplitude point on the tail. The virtual origin is the time that a straight line between the 10% and 90% amplitude points on the leading edge of the waveform intersects the  $I = 0$  line. Fig 14 shows these features of the nominal 8/20  $\mu\text{s}$  waveform.

The value of either the peak open-circuit voltage,  $V_p$ , or the peak short-circuit current,  $I_p$ , is to be selected by the parties involved, according to the severity desired, with a tolerance of  $\pm 10\%$ .

The effective source impedance, the ratio  $V_p/I_p$ , is specified as  $2.0 \Omega \pm 0.25 \Omega$ . This ratio determines the behavior of the waveform when various loads, such as surge-protective devices, are connected to the generator.

Traditionally, the 1.2/50  $\mu\text{s}$  voltage waveform was used for testing the basic impulse level (BIL) of insulation, which is approximately an open circuit until the insulation fails. The 8/20  $\mu\text{s}$  current waveform was used to inject large currents into surge-protective

devices. Since both the open-circuit voltage and short-circuit current are different aspects of the same phenomenon, such as an over-stress caused by lightning, it is necessary to combine them into a single waveform when the load is not known in advance (Richman, 1983 [B80]; Wiesinger, 1983 [B87]).

The tolerances for the 8/20  $\mu\text{s}$  current waveform are broader than those in IEC 60-2 (1973) [B92] and IEEE Std 4-1978 [B88]. The tolerances in those standards are for an 8/20  $\mu\text{s}$  current waveform without specifying the open-circuit voltage. These other standards also do not include the effects of a back filter and a coupling network, as required here.

**9.5 Equations for Standard Waveforms.**

Mathematical representations of the nominal waveforms are given in Table 6. These equations, and the value of the time constants, are useful for designing surge generators and for simulations of surge performance on digital computers (Standler, 1988 [B84]).

**Table 6**  
**Equations for Standard Surge-Test Waveforms**

0.5 $\mu\text{s}$ -100 kHz Ring Wave	
$V(t) = A V_p \left( 1 - \exp\left(-\frac{t}{\tau_1}\right) \right) \exp\left(-\frac{t}{\tau_2}\right) \cos(\omega t)$	
where	
$\tau_1$	= 0.533 $\mu\text{s}$
$\tau_2$	= 9.788 $\mu\text{s}$
$\omega$	= $2\pi \cdot 10^5$ rad/s
A	= 1.590
8/20 $\mu\text{s}$ Waveform	
$I(t) = A I_p t^3 \exp\left(-\frac{t}{\tau}\right)$	
where	
$\tau$	= 3.911 $\mu\text{s}$
A	= 0.01243 ( $\mu\text{s}$ ) <sup>-3</sup>
1.2/50 $\mu\text{s}$ Waveform	
$V(t) = A V_p \left( 1 - \exp\left(-\frac{t}{\tau_1}\right) \right) \exp\left(-\frac{t}{\tau_2}\right)$	
where	
$\tau_1$	= 0.4074 $\mu\text{s}$
$\tau_2$	= 68.22 $\mu\text{s}$
A	= 1.037

NOTE: In all the equations above:

- $t$  = Time
- $V_p$  = Maximum or peak value of the open-circuit voltage
- $I_p$  = Peak value of the short-circuit current

A test waveform in the laboratory will, of course, not exactly match the waveform given by the equations for the nominal waveform due to the tolerances of components in pulse forming networks and parasitic inductances and capacitances in the components of both generators and test fixtures.

The loading by the EUT may cause appreciable discrepancy between the preset nominal open-circuit voltage or short-circuit current and the actual voltage across or current in the load.

This effect is the reason why surge waveform parameters are not specified with the EUT connected. In computer simulations, some of the loading effects can be taken into account by including the effective output impedance,  $V_p/I_p$ , with the ideal voltage or current source.

### 10. Definition of Additional Surge-Testing Waveforms

The three additional waveforms are the EFT burst, the unidirectional 10/1000  $\mu$ s wave, and the 5 kHz Ring Wave. Each of these waveforms has a unique domain of application (contactor interference, fuse operation, and capacitor switching). Consequently, the waveform definition, the amplitude selection, and the test procedures are discussed separately for each waveform in 10.1, 10.2, and 10.3. Plots of the nominal waveforms are shown in Figs 15-18. The suggested peak voltages and source impedances that correspond to various environmental exposures are shown in Tables 7, 8, and 9.

**10.1 The Electrical Fast Transient (EFT).** This waveform consists of repetitive bursts, with each burst containing individual unidirectional pulses. As discussed in 7.4.4, this waveform has been proposed as a method for evaluating the immunity of equipment against interference; it is not a "representation" of the surge environment. The amplitude levels proposed for the various degrees of severity have been set by consensus as representing a realistic stress for the typical equipment exposed to the test. They should not be construed as actual voltage levels occurring in the mains.

The characteristics of this waveform and the corresponding test procedures are summarized in the following paragraphs, based on the

specifications of IEC 801-4 (1988) [5] (see *EFT Test* in Appendix B6 for details). However, readers are cautioned that IEC documents are subject to periodic revision. Therefore, any detailed plan for specific tests calling for the EFT should be based on the current version of the IEC document, not on the description provided herein.

**10.1.1 Waveform Definition.** The individual EFT pulses in a burst are defined as

Rise time:  $5 \text{ ns} \pm 1.5 \text{ ns}$   
Duration:  $50 \text{ ns} \pm 15 \text{ ns}$

The rise time is defined as the time difference between the 10% and 90% amplitude points on the leading edge of the waveform.

The duration is defined as the full width at half-maximum (FWHM), that is, the time difference between the 50% amplitude points on the leading and trailing edge of each individual pulse.

Individual pulses occur in bursts with a duration of  $15 \text{ ms} \pm 3 \text{ ms}$ . Within each burst, the repetition rate of pulses is specified as a function of the peak open-circuit voltage:

For peaks  $\leq 2 \text{ kV}$ :  $5 \text{ kHz} \pm 1 \text{ kHz}$   
For peaks  $> 2 \text{ kV}$ :  $2.5 \text{ kHz} \pm 0.5 \text{ kHz}$

(These two values of the repetition rate are specified in IEC 801-4 (1988) [5] and only reflect limitations in inherent performance of pulse generators, not characteristics of the environment.)

The period of the repeated bursts is  $300 \text{ ms} \pm 60 \text{ ms}$ . A plot of a single pulse is shown in Fig 15 and the burst pattern is shown in Fig 16.

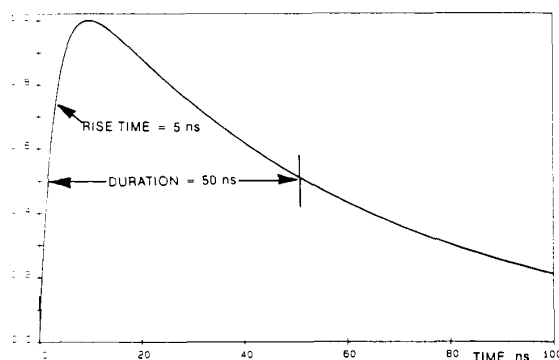
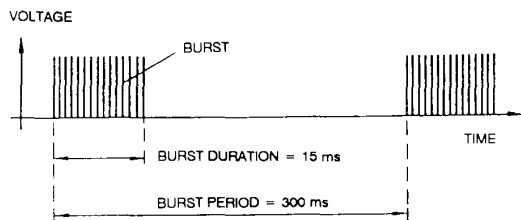

Fig 15  
Waveform of the EFT Pulse



**Fig 16**  
**Pattern of EFT Bursts**

**10.1.2 Amplitude.** The amplitude of the EFT pulses is specified by IEC 801-4 (1988) [5] as an open-circuit test voltage, while the waveform is defined when the generator is connected to a 50 Ω load. The generator is also defined as having a 50 Ω source impedance between 1 MHz and 100 MHz.

The resulting current, when the pulses are applied to the EUT according to the methods described in 10.1.3, is not defined since it will depend on the impedance exhibited by the EUT at the frequencies associated with the EFT waveform. Because the purpose of the test is to evaluate interference immunity, not energy capability, the specification of a current amplitude is not essential. Given this definition of the test level, the specific value should be selected by the parties involved, according to the severity desired, with a tolerance of ±10%.

In IEC 801-4 (1988) [5], five test-severity levels are specified, from 0.5 kV to 4 kV open circuit, with provision of an additional, special level open to negotiations. In keeping with the approach taken in the present recommended practice, only three levels, I, II, and III, are shown in Table 7. Because the additional waveforms described in the present document are only suggestions, there is always the implicit provision that other levels may be negotiated.

**10.1.3 Test Procedures.** The coupling methods for the EFT test are specified in IEC 801-4 (1988) [5], from which the essential characteristics are cited in the following. Two coupling methods are specified, depending on the nature of the EUT interface cable. (See *EFT Test* in Appendix B6 for more details).

**Table 7**  
**Levels for EFT Burst**

Test Severity	Peak Voltage (Open-Circuit)
I	1 kV
II	2 kV
III	4 kV

One method in particular, for single and polyphase ac interface, uses direct coupling to each of the cable conductors selected by discrete capacitors. The other method uses a “coupling clamp” that in fact also produces capacitive coupling to the interface cable on which the clamp is installed, in a global coupling mode.

Thus, both coupling methods result in having a capacitive divider (coupling capacitor and internal capacitance of the EUT) that applies the pulses at the port of the EUT (Martzloff and Leedy, 1990 [B47]). The actual value of the pulse applied at the EUT port is influenced by the internal design of the EUT; it is not a fixed parameter imposed on the EUT. Even the external arrangement of the EUT, including cable dressing and enclosure position with respect to the reference ground plane, will affect the capacitive coupling. The configuration of the test set-up, therefore, has to be clearly specified and documented.

**10.2 The 10/1000 μs Wave**

**10.2.1 Waveform Definition.** The front time and duration, as defined in 9.4.2, are the following:

Open-circuit voltage:  
Front time: 10 μs (+0, -5) μs  
Duration: 1000 μs (+1000, -0) μs

Short-circuit current:  
Front time: 10 μs (+0, -5) μs  
Duration: 1000 μs ± 200 μs

Some ambiguity exists in the definitions of this waveform given in other references, depending on the interpretation of the 10 μs “front” specification (Standler, 1988 [B84]). Because the major purpose of this waveform, in the present context, is to provide an energy stress, the difference between the rise time, time to peak, or front time is negligible. A plot of the nominal current is shown in Fig 17.



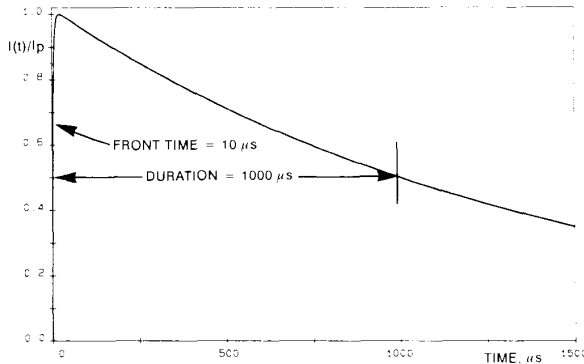

**Fig 17**  
**Waveform for the 10/1000  $\mu$ s Current Surge**

**10.2.2 Amplitude.** There is a major difference in the application of this waveform compared to that of the two standard waveforms: the concept of Location Categories that was used for the standard waveforms is no longer applicable. (That concept is based on the limiting effect of the inductance of branch circuits at the frequencies associated with the two standard pulses, presumed to have a decreasing severity as distance from the service entrance increases.)

The long duration of the 10/1000  $\mu$ s waveform reduces the effect of inductance. However, depending on the environment of the site, there is still a range of levels to be considered. Therefore, the values shown in Table 8 for the three system-exposure levels are applicable to all location categories.

The amplitude of the peak open-circuit voltage is to be selected by the parties involved according to the severity desired, with a tolerance of  $\pm 10\%$ .

The corresponding ratios of the peak open-circuit voltage to the peak short-circuit current,  $V_p/I_p$ , are shown in Table 8.

**10.2.3 Test Procedures.** IEEE C62.45-1987 [8] advises that powered testing of equipment is preferred, a method that is further recommended in the present document for the standard waveforms. However, the 10/1000  $\mu$ s test waveform is suggested primarily for its high-energy characteristic, stressing any surge-protective device that an EUT may contain.

The long duration of the wave makes a conventional back filter difficult to implement.

Three strategies may be applied to resolve this difficulty. The first would be to perform tests on unpowered equipment for the sole purpose of assessing the capability of the EUT for handling the energy associated with this waveform. If such a strategy were adopted, the amplitude of the applied surge should be that defined as  $V_{total}$  in the first footnote of Table 8, not the value of surge alone, in order to raise the voltage level to the equivalent stress.

However, the outcome of such a test does not address the concerns, discussed in IEEE C62.45-1987 [8], such as pre-surge stress, failure modes, or the need to have the EUT operational. Therefore, except when testing simple components—and fully recognizing the limitations—it is not the recommended approach.

The second strategy is based on the test method that has been proposed in a VDE<sup>10</sup> standard [B94] that calls for application of a surge obtained by discharging a large capacitor into the EUT at the peak of the mains voltage. The exact parameters of the test circuit have been modified since the first publication of the VDE standard and may be modified again. Therefore, in spite of the strong desirability of harmonization, firm specifications for this approach cannot be defined in the present context. A brief overview and discussion of this procedure is provided under **VDE 0160 high-energy test** in Appendix B24.

The third strategy is to obtain the complete waveform (power frequency before and after the surge, as well as total surge) from a digital waveform generator, with amplification by a high-power linear amplifier. This method requires that the amplifier be capable of delivering either voltage or current peaks during the surge (depending upon the EUT impedance, in a manner similar to the standard Combination Wave), as well as the normal load current of the EUT. This strategy would be a radical departure from the classical method of using the discharge of stored energy. It would offer the advantage, once the resource of such a system becomes available to a user, of making other test waveforms easy to implement.

<sup>10</sup>VDE = Verband Deutscher Elektrotechniker e.V. IEC recommendations for immunity tests, still under development, may incorporate this procedure in future documents (Martzloff, 1990 [B73]).

**Table 8**  
**Levels for the Additional 10/100  $\mu$ s Waveform**

Exposure	Surge Voltage Peak*	Source Impedance†‡
Low (residential)	None	
Medium (commercial)	1.0 $U_{pk}$	1.0 $\Omega$
High (industrial)	1.3 $U_{pk}$	0.25 $\Omega$

\*The surge voltage peak is proportional to the system peak voltage,  $U_{pk}$ . The values shown in this column are those of the surges alone, to be added to whatever the value of the mains voltage is for the phase angle at which the surge is applied.

For instance, the peak total voltage applied to a piece of equipment at the end of a long cable, upon clearing of a fault by a fuse and occurring near the peak of the power-frequency sine wave, would be, for a 120 V rms L-N system and for the high exposure level:

$$V_{total} = 170 V_{(sine\ wave)} + 1.3 \times 170 V_{(surge\ alone)} = 390 V$$

†The data base does not provide sufficient information to set an impedance value. The values shown in this table have been set by consensus as a reasonable value to provide guidance and uniformity in test procedures.

‡The effective impedance of the surge source, emulated by the test generator, is defined as the ratio of the peak voltage to the peak current. It has the dimension of a resistance, but is not a pure resistance.

**10.3 The 5 kHz Ring Wave**

**10.3.1 Waveform Definition.** This waveform is defined only by its open-circuit voltage parameters:

- Rise time: 1.5  $\mu$ s  $\pm$  0.5  $\mu$ s
- Ringing frequency: 5 kHz  $\pm$  1 kHz
- Ratio of adjacent peaks of opposite polarity: 60% to 80%

The rise time is defined as the time difference between the 10% and 90% amplitude points on the leading edge of the first peak of the waveform. The frequency is to be calculated from the first and third zero crossing after the initial peak. A plot of the nominal waveform is shown in Fig 18.

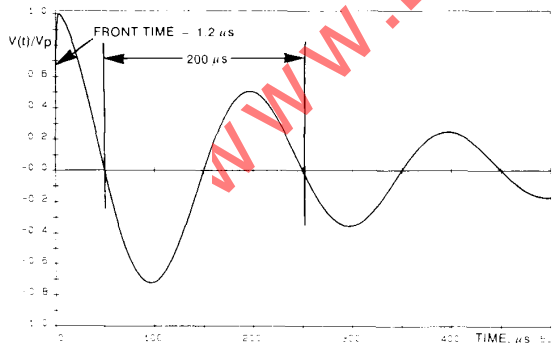

**Fig 18**  
**Waveform for 5 kHz Ring Wave**

**10.3.2 Amplitude.** There is a major difference in the application of this waveform compared to that of the two standard waveforms: the concept of Location Categories that was used for the standard waveforms is no longer applicable. (That concept is based on the limiting effect of the inductance of branch circuits at the frequencies associated with the two standard surge test waves, which causes the amplitude of the current to decrease as distance from the source of the surge increases.)

The branch circuit inductance has a negligible effect on the propagation of this 5 kHz Ring Wave. However, there is still a range of exposure levels to be considered, depending on the system exposure of the site. Therefore, the values shown in Table 9 are applicable to all locations categories.

The effective source impedance for the test generator—the ratio of the peak open-circuit voltage to short-circuit current,  $V_p/I_p$ —is specified as 5  $\Omega \pm$  2  $\Omega$ .

The nominal amplitude of the first peak of the open-circuit voltage is to be selected by the parties involved, according to the severity desired, with a tolerance of  $\pm 10\%$ . This peak surge voltage is proportional to the peak of the mains voltage. The source impedance, however, should take into consideration the rating of the system elements involved in generating the switching transient. Each particular case of installation will have its own characteristics: type of switching device, system inductance, grounding, kVAR size of the bank, and how often this bank is switched.

**Table 9**  
**Levels for the Additional 5 kHz Ring Wave**

Exposure	Surge Voltage Peak*	Source Impedance†
Low (far from switched banks)	None	
Medium	1.0 $U_{pk}$	1 to 5 $\Omega$
High (near large switched banks)	1.8 $U_{pk}$	0.5 to 1 $\Omega$

\*The surge voltage peak is proportional to the system peak voltage,  $U_{pk}$ . The values shown in this column are those of the surges alone, to be added to whatever the value of the mains voltage is for the phase angle at which the surge is applied.

For instance, the peak total voltage applied to a piece of equipment in the case of a restrike occurring near the peak of the power-frequency sine wave during a capacitor switching operation would be, for a 120 V rms system and for the high exposure level:

$$V_{total} = 170 V_{(sine\ wave)} + 1.8 \times 170 V_{(surge\ alone)} = 476 V$$

†The data base does not provide sufficient information to set an impedance value. The values shown in this table have been set by consensus as a reasonable value to provide guidance and uniformity in test procedures. See under *switching surges* in Appendix B for further discussion of the parameters.

**10.3.3 Test Procedures.** The 5 kHz Ring Wave is defined so that it can be applied to the mains connection of the equipment while the equipment is operating. For this type of test, it is necessary to interpose a back filter between the EUT and the mains, and to use a coupling network between the surge generator and the EUT, as described in IEEE C62.45-1987 [8].

The presence of the back filter and the coupling network, and the low impedance of the mains, may alter the surge wave shape compared to that observed at the output terminals of the surge generator alone.

When the intent of surge testing is to apply surges to the mains connection of the EUT while the equipment is operating, the effect of the back filter and the coupling network on the surge waveform must be included when determining the surge wave shape. That is, the expression "open-circuit voltage" means that the EUT is not connected, but the surge coupler and back filter have to be connected. These two elements are parts of the surge generator system, since they may affect the wave applied to the EUT.

It is therefore recommended that the surge waveform specifications for the 5 kHz Ring Wave be satisfied prior to the test of the EUT when:

- (1) The surge generator is connected to the back filter via the coupling network in the relevant coupling mode, and
- (2) All of the conductors of the mains connection, including protective ground,

are temporarily disconnected from the mains and shorted together at a point upstream from the back filter.

By shorting the mains upstream from the back filter (prior to the actual powered test), the effects caused by differing impedances of the mains from one laboratory to another are avoided. Allowing the ac supply mains to be disconnected and simulating the low impedance of the mains by shorting the conductors together is the recommended procedure to determine peak voltage and current. In this manner, the available short-circuit surge current and the open-circuit surge voltage (as defined above) at the EUT power line interface can be readily verified. Note, however, that this procedure establishes the voltage peak of the surge alone. The timing of the surge application with respect to the power-frequency sine wave will then determine the peak of the total surge, which is the significant parameter in the response and stress of a clamping surge-protective device.

**10.4 Equations for Additional Waveforms.** Mathematical representations of the nominal waveforms are given in Table 10. These equations, and the value of the time constants, are useful for designing surge generators and for simulations of surge performance on digital computers (Standler, 1988 [B84]).

A test waveform in the laboratory will, of course, not exactly match the waveform given by the equations for the nominal waveform

due to the tolerances of components in pulse-forming networks and parasitic inductances and capacitances in the components of both generators and test fixtures.

The loading by the EUT may cause appreciable discrepancy between the preset nominal open-circuit voltage or short-circuit current and the actual voltage across or current in

the load.

This effect is the reason why surge waveform parameters are not specified with the EUT connected. In computer simulations, some of the loading effects can be taken into account by including the effective output impedance,  $V_p/I_p$ , with the ideal voltage or current source.

**Table 10**  
**Equations for Additional Surge-Test Waveforms**

10/1000 $\mu$ s Waveform	
$I(t) = A I_p \left( 1 - \exp \left( -\frac{t}{\tau_1} \right) \right) \exp \left( -\frac{t}{\tau_2} \right)$	
where	
$\tau_1$	= 3.827 $\mu$ s
$\tau_2$	= 1404 $\mu$ s
A	= 1.019
5 kHz Ring Wave	
$V(t) = A V_p \left( 1 - \exp \left( -\frac{t}{\tau_1} \right) \right) \exp \left( -\frac{t}{\tau_2} \right) \cos(\omega t)$	
where	
$\tau_1$	= 0.7356 $\mu$ s
$\tau_2$	= 280.4 $\mu$ s
$\omega$	= $\pi 10^4$ rad s <sup>-1</sup>
A	= 1.027
EFT Waveform	
$V(t) = A V_p \left( 1 - \exp \left( -\frac{t}{\tau_1} \right) \right) \exp \left( -\frac{t}{\tau_2} \right)$	
where	
$\tau_1$	= 3.5 ns
$\tau_2$	= 55.6 ns
A	= 1.270

NOTE: In all the equations above:

- $t$  = Time
- $V_p$  = Maximum or peak value of the open-circuit voltage
- $I_p$  = Peak value of the nominal short-circuit current

## Appendixes

(These appendixes are not part of IEEE C62.41-1991, IEEE Recommended Practice on Surge Voltages in Low-Voltage AC Power Circuits, but are included for information only.)

Three appendixes are presented in support of this recommended practice:

- Appendix A: Presentation and discussion of the data base used to develop the recommendations and suggestions on surge characteristics.
- Appendix B: Additional information complementing this recommended practice.
- Appendix C: Annotated bibliography on the citations that appear in the text in the format [Bxx].

### Appendix A

#### Data Base

This appendix provides in more detail the data base supporting the summary in Section 6 of the recommended practice, which in turn led to the recommendations of Sections 8, 9, and 10.

The data base consists of a body of published information and otherwise unpublished documentation contributed by many individuals or organizations. These contributions are gratefully acknowledged.

This appendix is organized in six sections: Section A1 presents, unaltered, the data base initially included in the 1980 edition of this document. Section A2 presents new contributions to the data base, in support of the standard and additional waveforms. Section A3 presents a general review of published data as of 1989, and Sections A4, A5, and A6 present comparisons and a discussion of the differences.

**A1. Initial 1980 Data Base.** Recordings and surge-counter data were contributed from several sources, in addition to the surge-counter data obtained by members of the working group. Representative oscillograms and summary statistics are reproduced in this section in support of the recommended levels and waveforms.

**A1.1 Recordings by Bell Telephone Laboratories.**<sup>1</sup> Typical surge-counter statistics for a 120 V line at the BTL facility in Chester, NJ, during 42 months of monitoring were:

146 counts at 300 V to 500 V  
14 counts at 500 V to 1000 V

<sup>1</sup>Data contributed by P. Speranza from internal BTL report.

3 counts at 1000 V to 1500 V  
3 counts above 1500 V

Oscillograms recorded at various locations of the Bell facilities are shown in Fig A1.

**A1.2 Recordings by General Electric Company.**<sup>2</sup> The surge-counter results are given in Tables A1 and A2 (from Martzloff and Hahn, 1970 [B21]).<sup>3</sup> It was found that

- (1) Three percent of the US locations surveyed experience frequent occurrences (one per week or more) above 1 200 V.
- (2) There is a 100:1 reduction in the rate of device failure when the withstand level is raised from 2 kV to 6 kV (clock failure rates).

Typical oscillograms are shown in Fig A2.

Simulated lightning strokes on a residential power circuit (laboratory model of a system) are shown in Figs A3–A6 (from Martzloff and Crouch, 1978 [B41]).

A 1.5 kA current impulse (approximately  $8/20 \mu\text{s}$ ) is injected in the *ground wire only* of a service drop (Fig A3). Higher currents produce flashover of wiring. The open-circuit voltage at a branch circuit outlet during the 1.5 kA impulse was found to be 2 200 V peak, 500 kHz oscillations (Fig A4). By connecting a 130  $\Omega$  load at the same outlet (1 A load), the voltage is reduced to 1 400 V peak, with more

<sup>2</sup>Data contributed by F. D. Martzloff.

<sup>3</sup>The numbers in brackets in the Appendixes correspond to the references listed in section 4 and Appendix C of this standard.

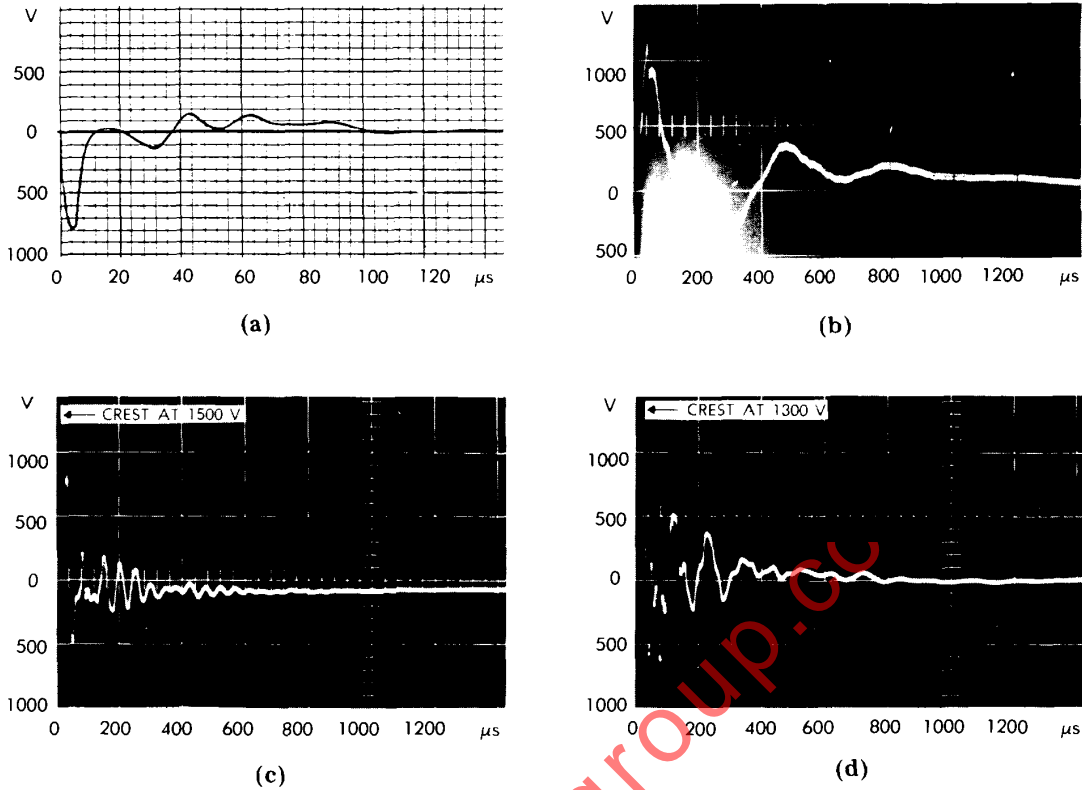

Fig A1

Typical Oscillograms

- (a) 120 V Outlet, Laboratory Bench
- (b) 277/480 V Service Entrance
- (c) 277/480 V Service Entrance
- (d) 277/480 V Service Entrance

damping (Fig A5). For a 30 kA injection (corresponding to an assumed 100 kA lightning strike on the distribution system), the discharge current passing through an arrester installed at the service entrance is 3.5 kA (Fig A6).

The following conclusions can be drawn from this test series:

- (1) A current of 1.5 kA (moderate for a lightning discharge injected into the ground system) raises the wiring system of the house 2.2 kV above ground. In the case of 4 kA (still a moderate value), this voltage would reach 6 kV, the typical sparkover value of this wiring.

- (2) A discharge current level on the order of 3 kA can be expected in an arrester installed at the service entrance when a very high current, 30 kA, is injected into the ground wire.
- (3) A natural frequency of 500 kHz is excited by a unidirectional impulse.
- (4) In this example, the source of the transient,  $Z$ , (from the loading effect of 130  $\Omega$ ) appears as

$$Z = 130 \Omega \left[ \frac{2200}{1400} - 1 \right] = 75 \Omega \quad (\text{Eq A1})$$



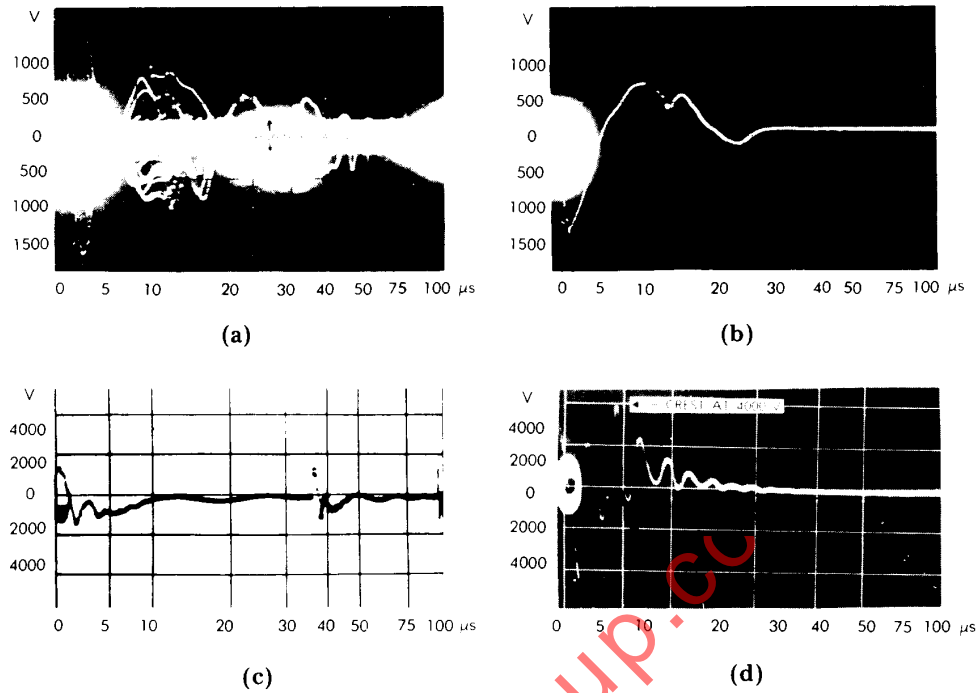

Fig A2

Typical Oscillograms

- (a) Furnace Ignition, 24 h Period
- (b) Furnace Ignition, Single Recording
- (c) Service Entrance, Lightning Storm
- (d) Street Pole, Lightning Storm

Table A1  
Number of Houses With Repetitive Surge Activity Above 1 200 V

Location	Number of Homes Surveyed	Recording Period (weeks)	Houses With Repetitive Surges
Providence, RI	4	2-6	None
Cleveland, OH	28	2-4	None
Auburn, NY	12	2-3	None
Lynchburg, VA	3	2-3	None
Syracuse, NY	8	1-2	1
Chicago, IL	23	1-6	None
Ashland, MA	24	1-2	1
Holland, MI	6	2-10	None
Louisville, KY	10	2-6	None
Somersworth, NH	50	1-2	1
Plainville, CT	5	10	None
Ashboro, NC	24	1-2	None
Fort Wayne, IN	38	1-4	3
DeKalb, IL	14	3-12	None

Table A2  
Surge-Counter Recordings Above 1 200 V (Spring, Summer, and Fall)

Location	Number of Homes	Total Homes x Weeks	Number of Surges
Providence, RI	6	60	1
Ashboro, NC	13	85	None
DeKalb, IL	11	60	2
Somersworth, NH	3	48	1
Chicago, IL	12	58	None
Cleveland, OH	8	106	1
Decatur, IL	12	72	2
Holland, MI	7	56	None
Auburn, NY	3	70	None
Springfield, PA	1	24	None
Ashland, MA	6	72	None
Pittsfield, MA	3	60	1
Plainville, CT	3	60	None
Lynchburg, VA	3	15	None
<b>Total</b>	<b>91</b>	<b>846</b>	<b>8 in 8 homes</b>

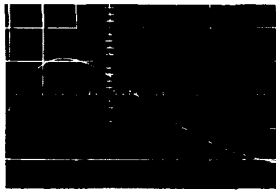

**Fig A3**  
Injected Current Impulse: 500 A/div and  
5  $\mu$ s/div

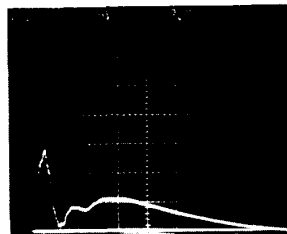

**Fig A5**  
Recording With 130  $\Omega$  Load: 500 V/div and  
2  $\mu$ s div

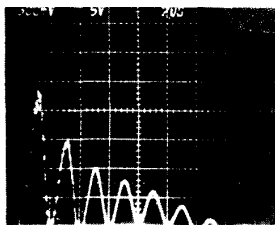

**Fig A4**  
Open-Circuit Recording: 500 V/div and  
2  $\mu$ s/div



**Fig A6**  
Discharge Current at Maximum Injection:  
500 V/div and 2  $\mu$ s/div

**A1.3 Statistics by Landis and Gyr Company.**<sup>4</sup> Surge recorders were installed at various locations of 220/380 V systems in Switzerland, monitoring the line-to-ground transients. Fig A7 shows a plot of the frequency of occurrence as a function of the voltage level for locations including residential apartments, commercial and industrial buildings, and a rural location served by a long overhead line. These transients recordings represent a composite of switching and lightning transients.

Switching transients measurements and calculations are the basis of the three curves shown in Fig A8, where the peak voltages reached for circuit interruptions at light load are plotted as a function of the system voltage. The fast transients (the time to the half-value,  $T_h = 5 \mu$ s) reach higher peaks than the long transients ( $T_h = 1\ 000 \mu$ s), but, in all cases, the peaks increase more slowly than the system voltage.

<sup>4</sup>Data contributed by L. Regez.

**A1.4 Working Group Surge-Counter Statistics.** Surge counters with four threshold levels (350 V, 500 V, 1 000 V, and 1 500 V) were made available to the working group by Joslyn Electronic Systems for recording surge occurrences at various locations. Members of the working group installed them on 120 V and 240 V systems of various types, including the following: outlets in urban, suburban, and rural residences; outlets in a hospital; secondary circuits on distribution system poles (recloser controls); secondary of pad mounted distribution transformers; lightning circuits in an industrial plant; life test racks at an appliance manufacturer; and the bench power supply in a laboratory.

Limitations on the availability of personnel and communications made this sampling less than optimum from a statistical point of view. However, by computing weighted averages for each location, one can quote an acceptable overall average; this average has been included when establishing the low- and medium-exposure limits.

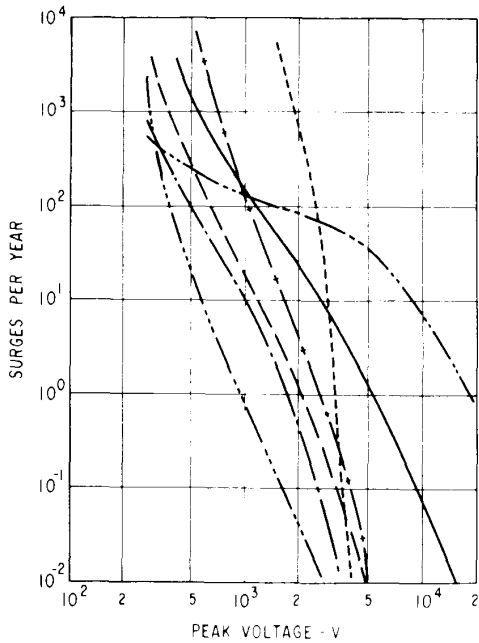

- Service entrance, 16-family house, under-ground system
- Same house, outlet third floor living room
- Same house, outlet fifth floor living room
- Service entrance of bank building in Basel
- Landis and Gyr Plant, Zug, outlet in lab.
- Landis and Gyr, Zug, outlet in furnace room
- Farmhouse supplied by overhead lines

**Fig A7**  
Rates of Surge Occurrence Recorded in a 220 V System

The statistics of these measurements can be summarized as follows:

- (1) The data base was collected from 18 locations with a total recording time of 12 years spread over 4 calendar years, using 6 counters.
- (2) The number of occurrences per year (weighted averages) at "average location" were:
 

350 V	22 occurrences
500 V	11 occurrences
1 000 V	7 occurrences
1 500 V	3 occurrences
- (3) The following extremes values were significant:
  - (a) One home experienced a large number of surges caused by washer operation.

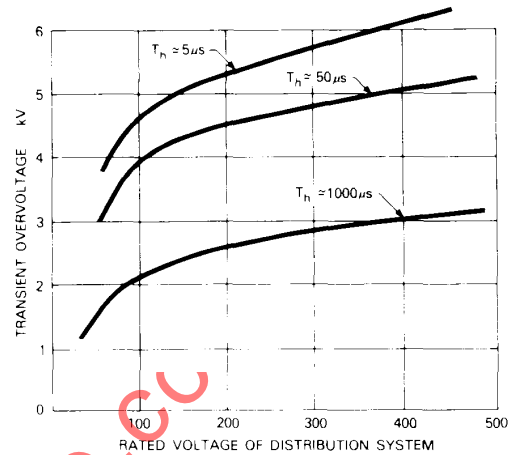

**Fig A8**  
Effect of System Voltage on Transient Overvoltages for Three-Pulse Durations

- (b) Four locations out of 18 never experienced a surge, perhaps due to the presence of continuous loads.
- (c) One home experienced several occurrences above 1 500 V, with none below that value.
- (d) One industrial location (switching of a test rack) produced thousands of surges in the 350–500 V range and several surges in excess of 1 500 V. This location was left out when compiling the average, but it is shown in the composite plot of Fig A9.

**A1.5 Combined Results.** From the data base described in this appendix, Fig A9 can be drawn together with the following information on voltage versus the frequency (rate) of occurrence:

- (1) The Bell Telephone Laboratories (BTL) data yield a point of 1 000 V at about two occurrences per year.
- (2) The General Electric Company (GE) counter statistics yield a point of 1 200 V at about one occurrence per year.
- (3) The GE clock data indicate a ratio of 100:1 in the rate of occurrence from 2 kV to 6 kV.
- (4) The Regez data provide a band for the majority of locations, with the exception of the rural location with a long overhead line, which has more occurrences.
- (5) Working group (WG) statistics indicate a more moderate slope, perhaps because of the influence of outdoor locations included in the sample (similar to the rural data of Regez). An extreme case of switching transients was also identified near a test rack (TR).

Three lines have been drawn. The medium-exposure and the low-exposure lines are parallel to the 100:1 reduction line. The high-exposure line, reflecting isolated cases, corresponds to locations where the higher voltages are not limited by clearance sparkover. These three bounded areas are shown on the plot of Fig 6 in the body of the recommended practice.

**A2. Additional Data.** Some of the data cited in this section have appeared in published documents, while others have been supplied to the working group by interested parties. These recordings complement the data base.

**A2.1 Surges Created by Clearing a Fault With a Current-Limiting Fuse in a Residential Environment.**<sup>5</sup> The three oscillograms of Figs A12-A14 are excerpted from an unpublished document reporting results of tests made by clearing short circuits at several residences in a 220/380 V residential distribution system. Various makes of fuses were used in the tests. The data show an inverse relationship between peak voltage and duration of the surges. Reported durations, however, are not as long as those of the Meissen data [B25].

**A2.2 Surges Created by Clearing a Fault With a Current-Limiting Fuse in an Industrial Environment.** The following two plots of Figs A10 and A11 show results from an inves-

tigation of 700 fuse operations in 220/380 V circuits, with various impedance configurations and several ratings and types of fuses [B25].

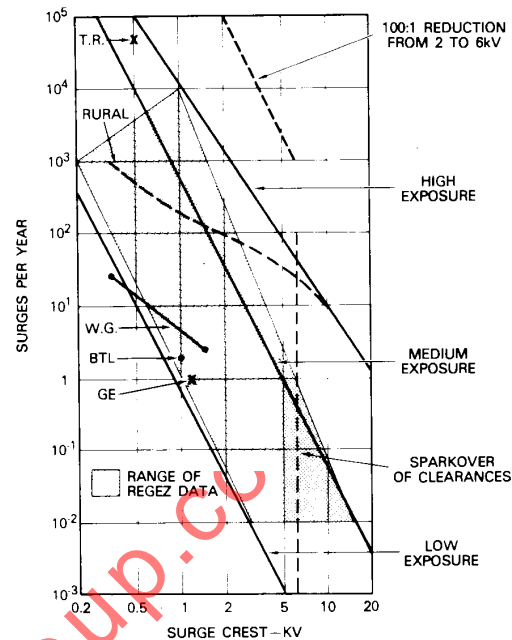
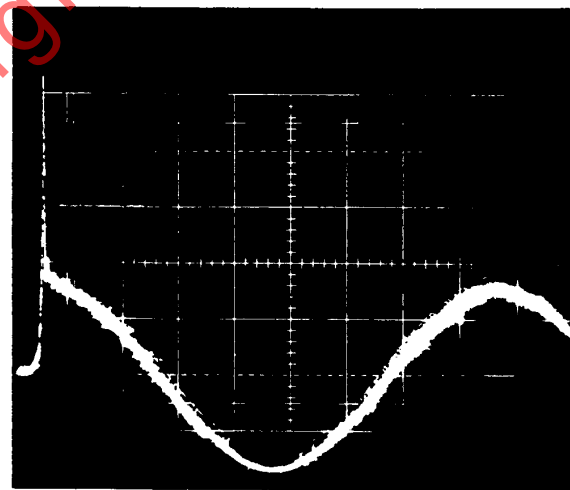

Fig A9  
Combined Transient Recording Data



Vert.: 200 V/div Sweep: 2.5 ms/div

NOTE: Power-system voltage is zero at origin until fuse clears, producing a surge.

Fig A10  
Voltage Pulse Accompanying Break of  
Current

<sup>5</sup>Data contributed by the Netherlands National Committee of the IEC.

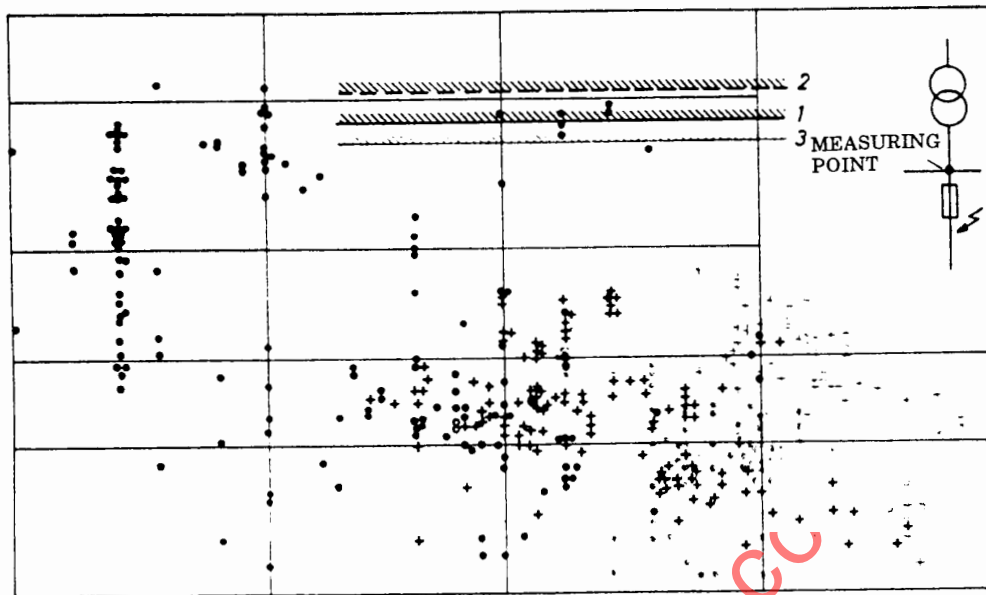

Source: Meissen [B25]

Fig A11  
Measured Overvoltage Factors for Short Circuits Behind a Branch-Circuit Fuse

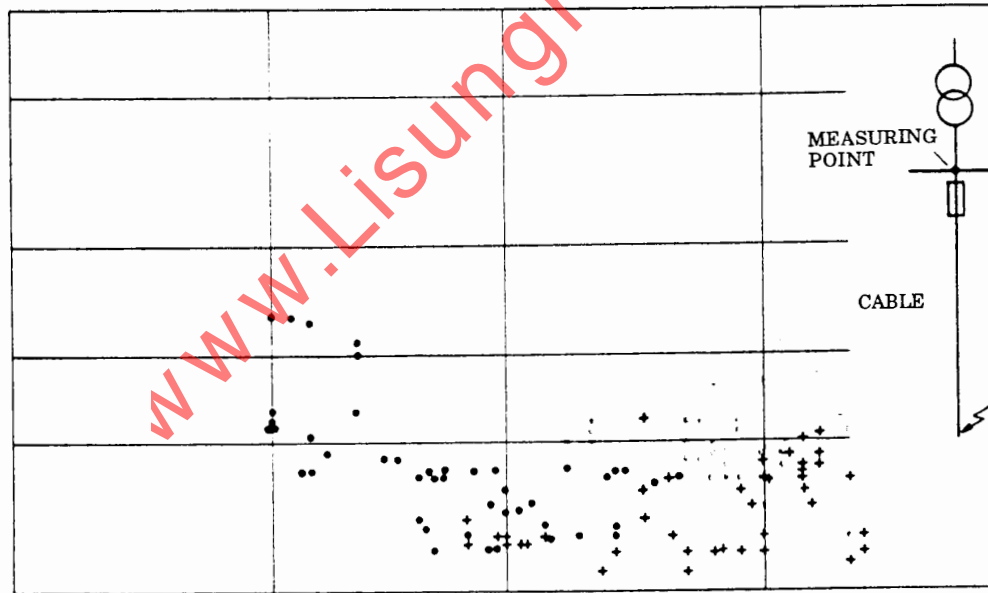

Source: Meissen [B25]

Fig A12  
Influence of Cable Length on Overvoltage at End of Cable

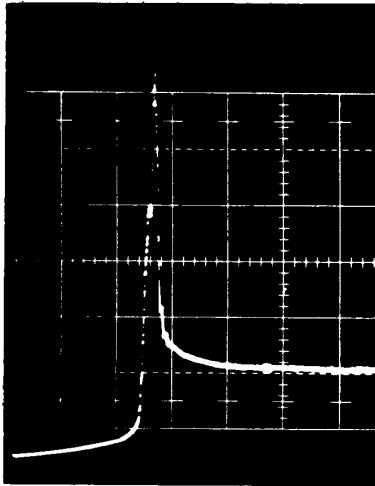

Vert.: 200 V/div Sweep: 250  $\mu$ s/div

**Fig A13**  
Surge With High Peak (1500 V) but Relatively Short Duration (100  $\mu$ s)

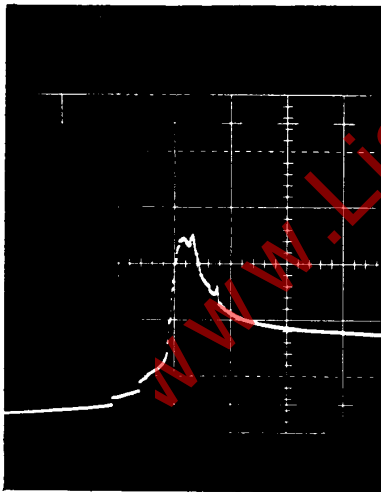

Vert.: 200 V/div Sweep: 250  $\mu$ s/div

**Fig A14**  
Surge With Long Duration but Relatively Low Amplitude

**A2.3 Surges Created by Switching of Capacitor Banks.** The oscillograms of Figs A15-A19 were recorded under conditions that were not fully defined, but were identified as associated with capacitor switching by the investigators who provided the information.

**A2.3.1 Large Capacitor Bank**

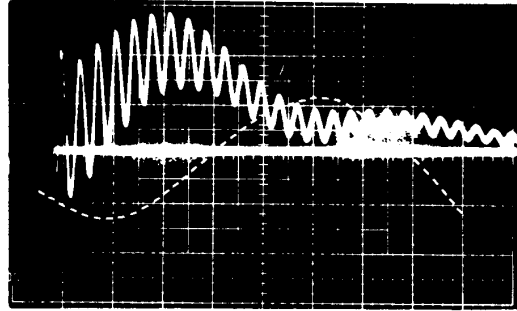

Vert.: 500 V/div Sweep: 0.5 ms/div

NOTE: Dotted sine wave shows amplitude of the mains voltage but not the same sweep.

Source: Martzloff, 1986 [B23]

**Fig A15**  
Surge, Recorded in the 480 V System, Produced by Switching On a 5.4 MVAR Bank at the 23 kV Utility Substation

**Table A3**  
Capacitor Energizing Surges

Without Varistors Peak		With Varistors
Peak (V)	$\times U_{pk}$	Peak (V)
1450	2.16	1100
1400	2.00	1100
1300	1.93	1050
1300	1.93	1050
1300	1.95	1050

Source: Martzloff, 1986 [B23]

This table shows the five highest transients recorded during a set of 10 switching operations of the bank of Fig A15, with or without varistors, at the point of measurement in the 480 V rms system (mains peak voltage,  $U_{pk} = 672$  V).



**A2.3.2 Typical Capacitor Switching Transients**

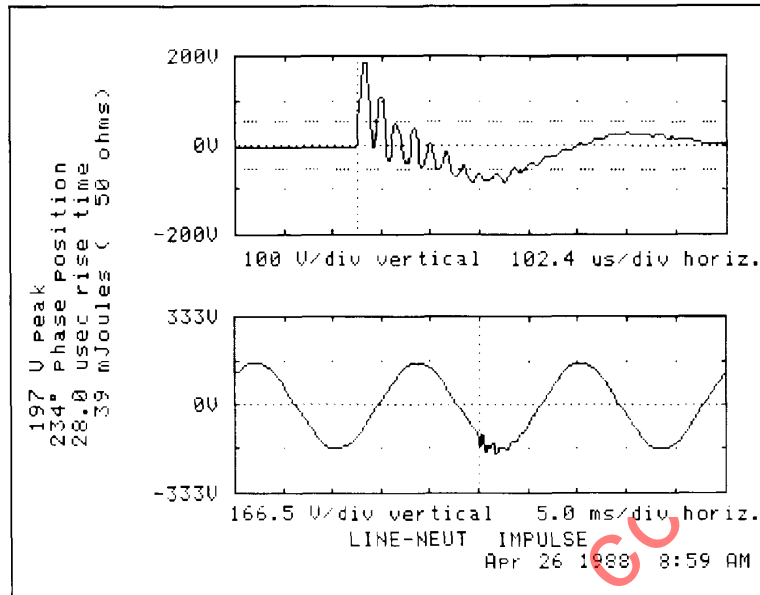

NOTE: This type of waveform has been found in lightly loaded buildings with fairly large step-down transformers. The waveform may be caused by interaction between the initial utility waveform and the resonant characteristics of the service entrance transformer.

**Fig A16**  
**Typical Capacitor Switching Transient Recorded on a 120 V rms System<sup>6</sup>**

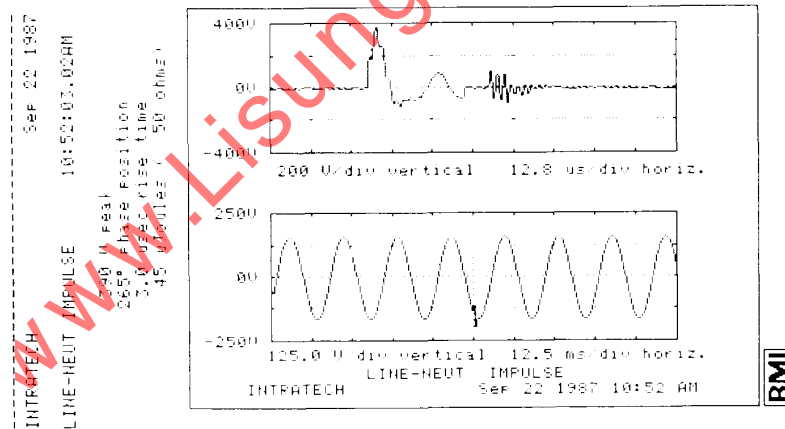

NOTE: This disturbance is caused by switching on a capacitor, thus causing an initial removal of energy from the line (positive initial rise occurring during the negative portion of the mains voltage). The resulting oscillation can be considered as a surge, according to the broad definition of surge.

Source: McEachern [B24]

**Fig A17**  
**Local Capacitive Load Switching**

<sup>6</sup>Unpublished oscillogram and comment contributed by T. Shaughnessy.

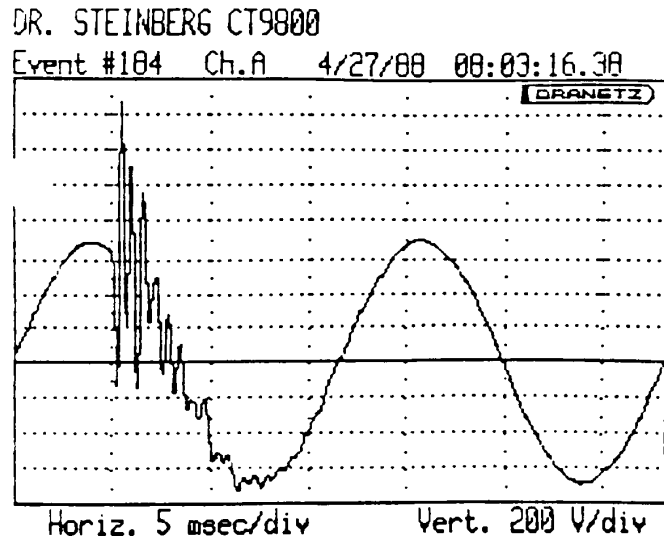
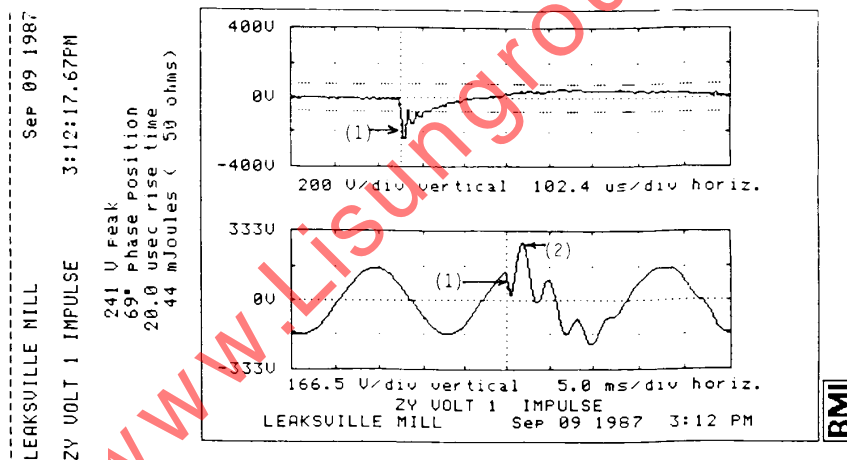

Fig A18  
Capacitor-Switching Transient Recorded in a Hospital Environment<sup>7</sup>



NOTE: This disturbance is caused by energization of a 600 kvar capacitor bank on the secondary side of a delivery transformer feeding an industrial customer. The capacitor is installed for voltage-regulation purposes and may switch several times a week. There are two components in this transient that may cause problems:

- (1) A high  $dv/dt$  resulting from the bus voltage suddenly changing to coincide with the uncharged capacitor
- (2) The transient overvoltage resulting from the natural frequency oscillation as the system settles to a new operating condition.

Fig A19  
Typical Industrial Capacitor-Switching Transient (Low-Voltage Bank)<sup>8</sup>

<sup>7</sup>Unpublished data contributed by H. Rauworth.

<sup>8</sup>Unpublished data and comment contributed by J. G. Dalton.

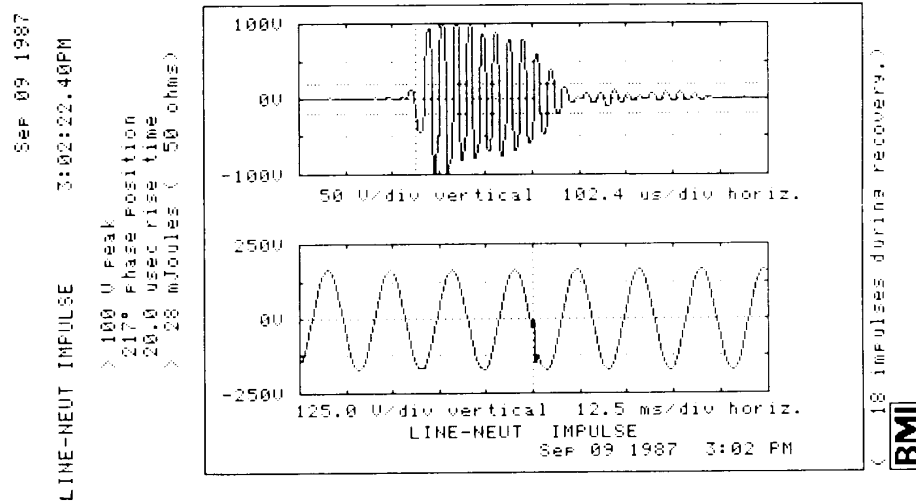

Source: McEachern [B24]

**Fig A20**  
**Lightning-Induced Ring Wave**

**A2.3.3 Ring Waves.** Ring waves can be produced by unidirectional stimulation of a power system, as shown by Figs A20 and A21.

**A2.3.4 Swells.** Swells have not been documented because they are generally outside of the area of interest of researchers investigating surges. Anecdotal reports on varistor failures might be explained by assuming the occurrence of a large swell or the cumulative effect of repeated swells (Martzloff and Leedy, 1989 [B46]). The two oscillograms in Fig A22 show the momentary overvoltage occurring upon recovery of a power system from a momentary undervoltage ("sag"). This overvoltage is at the boundary between the definitions of a surge and of a swell. These disturbances were identified as occurring during a thunderstorm, with several such disturbances a few seconds apart (note the time stamps on the records).

**A3. Review of Published Data.** This review first provides a chronological listing of published papers reporting surge monitoring surveys performed by independent researchers, with a synopsis of each paper. A comparison is then presented on the differences among the

reported results, including differences in surge amplitudes, waveforms, and rates of occurrence.

**A3.1 Bull and Nethercot.** In a 1964 article [B6], Bull and Nethercot report monitoring performed in the mid-1960s on 240 V systems in Great Britain with instruments of their design. Their first instrument used vacuum tubes, leading to the development of a solid-state circuit, which may be considered the forerunner of modern monitors. The instrument had several channels, each with a different threshold.

Eventually, the solid-state instrument was made available commercially, and several units of that design were used in some of the monitoring performed in the United States, as cited under A1.1 and A1.4.

The monitoring locations were selected to include a variety of conditions, with data collected for several weeks at each location, over a total period of two years. The results do not mention transients above 600 V; it seems that no channels were provided above that level because the authors were only concerned with the range of 50 V to 600 V.

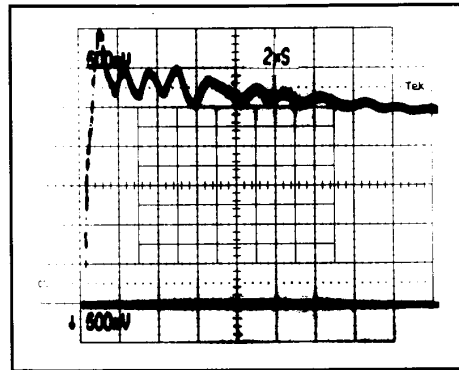

SURGE AT BUILDING SERVICE ENTRANCE,  
RESULTING FROM A COMBINATION WAVE  
APPLIED AT 480 V TRANSFORMER PRIMARY  
Vertical: 500 V/div Sweep: 2  $\mu$ s/div

Note line marked on the  
oscillogram to show  
unidirectional component.

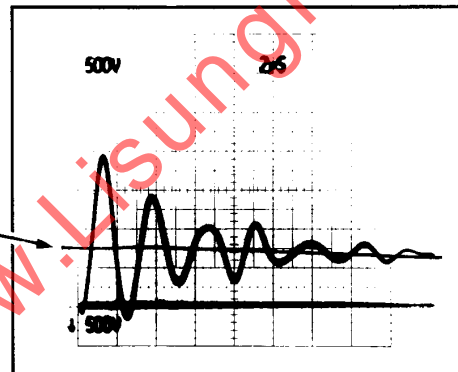

RESULTING SURGE WITHIN BUILDING, ON  
BRANCH CIRCUITS DOWNSTREAM FROM  
120/208 V TRANSFORMER SECONDARY  
Vertical: 500 V/div Sweep: 2  $\mu$ s/div

Source: Martzloff [B43]

**Fig A21**  
**Conversion of a Unidirectional Surge Into an Oscillatory Surge**

**A3.2 Martzloff and Hahn.** In a 1970 paper [B22], Martzloff and Hahn report the highlights of measurements made from 1963 to 1967 on residential, commercial, and industrial circuits, mostly single-phase 120 V. Waveform data were obtained with commercial, custom-modified oscilloscopes fitted with a motor-driven camera.

These oscilloscopes were installed at various locations where transient activity was suspected. In addition, a peak counter was developed, and 90 units with a 1.2 kV or 2 kV threshold were deployed at 300 locations where there was no prior suspicion of unusual transient activity.

The oscilloscope data gave one of the first indications that the traditional unidirectional impulse, long used for dielectric testing, might not be representative of surges occurring in low-voltage circuits. The threshold data indicated locations where surges above 1.2 kV occur frequently (about 3% of the sample), while other locations appeared to be far less exposed to surges. The 100:1 reduction of an alarming failure rate of clock motors, achieved by increasing the surge withstand capability of the motors from 2 kV to 6 kV, is documented in that paper.

**A3.3 Cannova.** In a 1972 paper [B7], Cannova

reports the monitoring of surges on U.S. Navy shipboard 120 V and 450 V power systems in the late 1960s. Instrumentation used for the initial phase of the monitoring program consisted of oscilloscopes similar to those used by Martzloff in [B22]. Provision was also included for the option of measuring the transients alone (through filters) or superimposed on the ac line voltage; this option reflects the old dichotomy, still unsettled to this day, as to whether the transients should be measured as an absolute value or as a deviation from the instantaneous value of the ac sine wave (see Table 1). The results are not reported separately for 120 V and 450 V systems: it is not possible to express them in per-unit terms, or as percentage of nominal system voltage.

Cannova's statistical treatment aims at fitting the recorded transients to a normal distribution and concludes that a log normal distribution is a better fit. A brief statement is made on the durations of the recorded transients (without a statement on how those durations are defined), citing a majority of durations between 4  $\mu$ s and 6  $\mu$ s, with a few at 19  $\mu$ s. From the data base, acknowledged to be a small total number of events, a protection level of 2.5 kV was defined. Two aspects of the conclusions are especially worth noting:

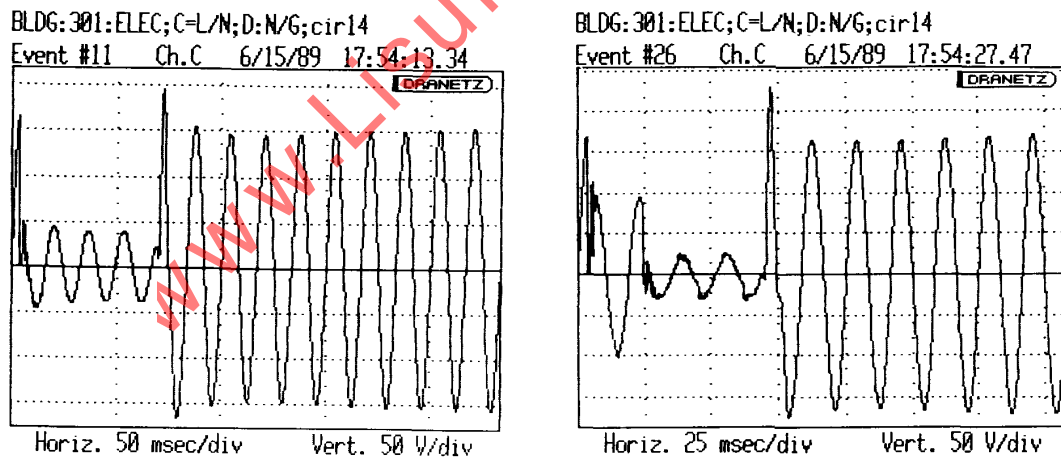

**Fig A22**  
**Swells Occurring Upon Recovery From a Remote System Fault<sup>9</sup>**

<sup>9</sup>Unpublished data contributed by F. D. Martzloff.

- (1) There was no information on the source impedance of the surges, and yet the data eventually served to specify requirements for surge protective devices.
- (2) A large difference in frequency of occurrence was noted among ships of the same type and class, similar to the observations made on land-based surveys.

**A3.4 Allen and Segall.** Allen and Segall, in a 1974 paper [B2], report the monitoring of several types of power disturbances at computer sites, performed with oscilloscopes, oscillographs, and digital instruments, from 1969 to 1972. Details of the instrumentation were described in a separate paper (Allen, 1971 [B69]). Disturbances are described as overvoltages and undervoltages, oscillatory decaying disturbances, voltage spike disturbances, and outages. The terms *sag* and *swell* had not yet made their appearances in the jargon.

The survey was conducted in two phases. In a first phase, preliminary information was obtained on ranges of disturbances, leading to the development of a second generation of monitors deployed in the next phase. The recorded disturbances are described by plots and histograms.

The highest surge recorded in the first phase is shown as 350 V. In the second phase, the monitors grouped all surges into three categories, the highest having a range of 100% (of line voltage) to infinity, so that no detailed information is provided to describe high peak values. The survey does report in detail the occurrence of undervoltages and overvoltages, providing a basis for the comparisons with the Goldstein-Speranza study mentioned in A4.

**A3.5 Goldstein and Speranza.** In a 1982 paper [B15], Goldstein and Speranza report monitoring several types of disturbances at a variety of locations in the Bell System, with digital multiparameter instruments, from 1977 to 1979. The conditions of the survey are documented, including instrument locations and definitions of the parameters, as well as the methods of data processing.

The findings are only briefly reported because emphasis is on predictions of disturbances expected at specific sites. The prediction is obtained by using a statistical model derived for all sites and making adjustments reflecting specific site conditions

determined by a limited survey at that site. The authors are emphatic about the point that the lack of correlation between sites prevents a blanket application of the overall findings to any specific site, but that useful predictions are possible by combining the overall data with limited knowledge on specific site data. This concept is echoed in Fig 6, presenting the frequency of occurrence in graphic form.

A Polya distribution is identified by Goldstein and Speranza as the best fit for this type of data on rare events, in contrast to other surveys where their authors attempted to fit a normal distribution or a power or exponential law profile.

**A3.6 Meissen.** In a 1983 paper [B25], Meissen reports the measurement of surges associated with the clearing of a fault by a current-limiting fuse in various industrial environments. The paper does not include oscillograms that would define the waveforms in detail, but does include several graphs showing the relationship between the peaks and the duration of the surges. Peak values are quantified in terms of  $x$  times the crest of the power frequency voltage, with values of  $x$  typically ranging from 1 to 3, and exceptionally from 1 to 10 for some of the lower ampere ratings of the fuses. The durations of the surges (FWHM) range from 0.1 ms to 3 ms.

These results were used in the development of VDE Standard 0160, as discussed in B24. See also the previously unpublished results of measurements in Dutch residential distribution systems reported in A2 (Figs A12–A14).

**A3.7 Wernström, Broms, and Boberg.** Wernström, Broms, and Boberg, in a 1984 report published in Sweden and circulated in the United States as a draft English translation [B34], report monitoring of industrial 220/380 V systems by digital multithreshold instruments, corroborated by waveform recordings with digital storage oscilloscopes. The parameters to be recorded and reported are defined in an introductory section; however, their description of “common mode” and “differential mode” in the English translation does not correspond to symmetrical and asymmetrical voltages defined by the IEC. In the section discussing transient sources and propagation, they make a significant comment that “common mode voltages are the most interesting and at the same time are the voltages most difficult to defend against.”



The range of surges recorded extends from 0.2 kV to 2 kV. In a summary tabulation, rise times are shown as ranging from 20 ns to 200 ns, and duration from 0.2  $\mu$ s to 2.5  $\mu$ s. An interesting additional measurement was made by simultaneous recordings at two distant points of the power distribution system, showing some aspects of the propagation and attenuation of a surge. Simultaneous multiple point recordings provide important results for individual users considering surge protection in distributed electronic systems such as local area networks. The survey also shows a wide difference of surge activity among sites but a relatively constant slope of the rate of occurrence versus level.

**A3.8 Aspnes, Evans, and Merritt.** In a 1985 paper [B3], Aspnes, Evans, and Merritt report a survey of the power quality in rural Alaska at isolated power generation facilities. The monitoring instruments are identified as one of the contemporary commercial digitizing monitors. A comprehensive summary of the recordings is presented, including "sags" and "surges" (the latter would be called "swells" according to the definitions of this document), "impulses" (i.e., surges), and outages.

Some ambiguity surfaced in connection with the possibility that built-in surge protection in the monitors might have attenuated the surges being recorded. Knowing the source impedance of the surges (not the impedance at power frequency) would have settled the issue. This case history points out, again, the desirability of including surge current monitoring in future surveys, as a method of characterizing the source impedance of the surges.

**A3.9 Odenberg and Braskich.** In a 1985 paper [B29], Odenberg and Braskich report monitoring computer and industrial environments with a digital instrument capable of the simultaneous recording of voltage surges and current surges. This new capability for relating voltage and current shows a growing awareness of the need to monitor current surges—an improvement over previous surveys limited to the measurement of voltages. However, the reported surge currents are those of a current toward undefined loads downstream from the instrument; they do not include any measurement of the current through a shunt-connected surge diverter, a measurement that would have provided new information on the source impedance of the surges.

The digital processing applied by the instrument yields two points of the surge: the peak value with the time to reach peak, and the time elapsed until decay to 50% of the peak value (see Fig A24). From these two points, a "waveform" description is proposed, without any other information on the actual waveform. From a large number of recorded surges (over 250 000 events), a startling finding is cited, that 90% of the recorded surges have their 50% point in a narrow window of only 900  $\mu$ s to 1100  $\mu$ s. Attempts to reconcile this singular finding with the observations reported by other surveys have not been successful.

**A3.10 Goedbloed.** In a 1987 paper [B14], Goedbloed describes in detail a custom-built automated measurement system used to monitor 220/380 V networks in Europe. By combining two commercial recorders with a custom interface, the system developers obtained recordings with a 10 ns sampling interval and 20  $\mu$ s window on the first recorder and a 1  $\mu$ s sampling interval and 2 ms window for the second recorder.

The system included provision for automated data reduction, yielding raw data as well as statistical information on amplitude, rate of rise, energy measure, spectral density, and conversions from time domain to frequency domain. With a relatively low threshold of 100 V above the line voltage, the distribution of occurrences is weighted toward low amplitudes; nevertheless, some occurrences are reported above 3 kV.

The Goedbloed paper also addresses indirectly the question of normal-mode versus common-mode surges by discussing symmetrical voltage and asymmetrical voltage as defined in the *IEC Multilingual Dictionary of Electricity* [3]. An indirect definition is proposed for a third type identified as the "so-called non-symmetrical voltage," which was the mode of monitoring used in this survey: line to grounding conductor (called "protective earth" or "protective conductor" in Europe).

This third type is currently incorporated in the more general definition of common mode proposed by IEEE C62.45-1987 [8], which might leave some ambiguity on the definitions, or lead to considering "pure common mode" as opposed to some combined mode in which both normal and common (pure) modes are combined.

Looking for guidance in IEC definitions does not help much: the IEC definition addresses delta networks, but the Goedbloed paper states that nearly all networks monitored were of the TN type—that is, phase, neutral (implying a wye), and protective-earth conductors. The paper clearly states the mode of connection, so there is no ambiguity, but this instance serves again to illustrate the need to harmonize definitions.

**A3.11 Standler.** Standler, in a 1989 paper [B37], describes the wave shapes of transients measured between line and grounding conductors and between the neutral and grounding conductors in a residence. Statistical analysis showed that the common-mode voltage (as discussed in B4) is usually much larger than the differential-mode voltage. He also showed that about half of the observed events during monitoring had a maximum value of  $|dV/dt|$  greater than 0.7 kV/ $\mu$ s, and about 10% had maximum values greater than 1.3 kV/ $\mu$ s. By analyzing rates of events when the home was occupied versus unoccupied, it was concluded that 60% of the transients observed in an occupied residence had an origin inside the building.

**A4. Relative Occurrence of Different Types of Disturbances.** Two of the surveys listed above have been widely cited, one performed in the early 1970s by Allen and Segall [B2], the other performed in the late 1970s by Goldstein and Speranza [B15]. Their findings do not at first appear to be in agreement; a difference seems to exist between the relative occurrence of different types of disturbances. However, a detailed comparison of these two surveys shows that the difference is attributable to the different thresholds set by each researcher. Thus, comparison provides a good illustration of the pitfalls of superficial interpretation of survey results (Martzloff and Gruz, 1988 [B61]).

**A5. Differences in Amplitudes.** The amplitudes of the surges reported in the surveys vary over a wide range, and comparisons are difficult because the data are not presented in a uniform format. An attempt was made to get a quantitative comparison of the amplitudes reported in these surveys. However, the exercise was quickly found to be futile, because of the following two main reasons (Martzloff and Gruz, 1988 [B61]):

- (1) Looking at “maximum values,” one finds that in some surveys the quoted maximum is actually a value in excess of the range of the instrumentation, while for others it is the measured value. There are too few points and insufficient information to attempt a statistical treatment of this truncated data base (censored data in statistical terms). Furthermore, the quoted value in some surveys is the total voltage (instantaneous value of ac sine wave plus surge), while in others the sine voltage has been filtered out. When surges are in the range of several thousand volts (the concern being damages), the difference between the two definitions is not significant; however, when surges are in the range of a few hundred volts (the concern being malfunctions), the difference is significant.
- (2) Because the lower threshold of the recorder varies among surveys, and the frequency of occurrences increases dramatically with lower threshold, the labels of average, median, most frequent, typical, etc., are not meaningful for comparing amplitudes.

For these two reasons, any comparison at the present stage of inconsistency in report formats can only be qualitative. Conjecture or speculation, rather than hard facts, might explain differences, as illustrated in the following two examples.

The relatively small number of high-amplitude surges reported by Allen and Segall [B2] compared to other surveys might be explained by a limitation of their instrument, as discussed in Martzloff and Gruz, 1988 [B61].

Briefly stated, the storage oscilloscopes used by Allen and Segall had the limited writing speed of contemporary technology; furthermore, the small amplitude set for full scale was such that a high-amplitude transient would have its peak offscreen, and the steep rise would not be recorded on the phosphor.

Fig A23 shows oscillograms recorded by Martzloff in preparation for a discussion of the Allen and Segall conference paper.<sup>10</sup> The

<sup>10</sup>Discussions of conference papers are not printed by the IEEE.

oscilloscope used by Martzloff was of the same model as those used by Allen and Segall.

Oscillogram (a) shows an actual 2200 V transient appearing as a benign 400 V transient when the oscilloscope is set in anticipation of relatively low-amplitude transients and relatively low speed, as was the case with the Allen and Segall monitoring.

Oscillogram (b) shows what the same oscilloscope displays with different settings.

Oscillogram (c) shows the transient as recorded with an oscilloscope having a higher writing speed.

Another difference in observed amplitudes is found in the results of the Alaska power survey (Aspnes, Evans, and Merritt, 1985 [B3]). An explanation for the relatively low surge level observed was suggested in the discussion of that paper: the built-in surge protection of the power supply for the internal electronics of the monitor might have reduced the levels of the surges observed by the monitors, which had their power cord and monitoring probe connected to the same duplex receptacle.

A further explanation of some differences in amplitudes found in the various surveys might be the fact, observed by some of the authors, of the lack of correlation between sites.

Finally, some surveys include sites where equipment failures were experienced or expected, while other surveys were made at sites not singled out for particular problems.

**A6. Differences in Waveforms.** The "typical" forms suggested by each author from those surveys made with waveform recording capability have been collected in Fig A24. The finding of ringing waves, as opposed to the traditional unidirectional impulses, seems general in these low-voltage circuits.

**A6.1 Martzloff and Hahn.** Martzloff and Hahn [B22] were among the first to report ring waves; their reported measurements were incorporated into the data that resulted in the eventual selection of a 100 kHz ring wave with a 250 ns or 500 ns rise time for UL 93-1975 [B90] and the 0.5  $\mu$ s-100 kHz Ring Wave for the 1980 edition of this recommended practice.

**A6.2 Cannova.** Cannova [B7] does not report detailed descriptions of the waveforms, but his statements "4  $\mu$ s to 6  $\mu$ s" and "up to 19  $\mu$ s" could be interpreted either as a time to half-value or as the time between the initial rise and the first zero crossing of a ringing wave. Interestingly, that data base led to the specification of a

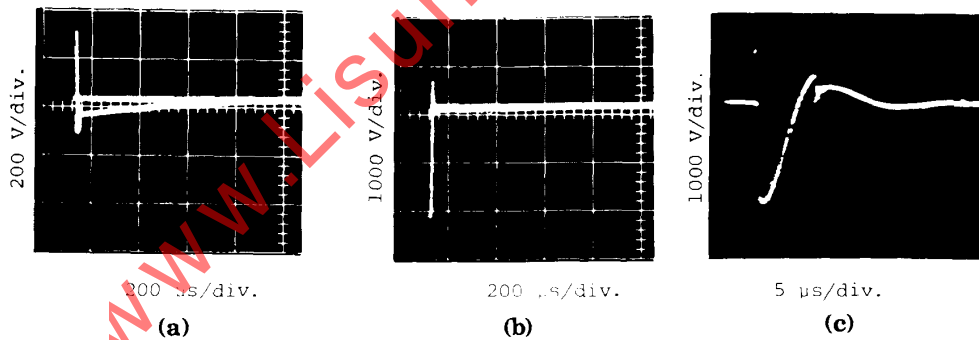

Source: Martzloff and Gruz [B61]

**Figure A23**  
**Possible Explanation for Low Values of Reported Transients**

NOTE: Appearance of recordings made with storage oscilloscope and high-speed oscilloscope. (a) Low full scale and slow sweep. Screen storage oscilloscope, 1968 vintage (same type as used by Allen-Segall). (b) High full scale and slow sweep. Screen storage oscilloscope, 1968 vintage (same type as used by Allen-Segall). (c) High full scale and fast sweep. High-speed oscilloscope, 1968 vintage.

unidirectional, longer impulse, the classic 1.2/50  $\mu$ s voltage impulse for the shipboard environment.

**A6.3 Wernström, Broms, and Boberg.** Wernström, Broms, and Boberg [B34] show three examples of their recordings. The first is indeed a ring wave with a frequency of about 500 kHz and rise time of 200 ns. The second example is a burst of nanosecond-duration transients, similar in shape to the electrical fast transient in IEC 801-4 (1988) [5].

**A6.4 Odenberg and Braskich.** Odenberg and Braskich [B29] report data different from the other authors in that only two points of the waveform are reported: peak and 50% of peak amplitude. As such, this description is not a complete waveform; furthermore, the report that 90% of their 250 000 recordings show the 50% point occurring between 900  $\mu$ s and 1100  $\mu$ s is unique among all surveys.

**A6.5 Goedbloed.** The Goedbloed [B14] data presentation reflects concerns addressing interference rather than damage; hence, the emphasis was given to amplitude, rate of rise, and energy, rather than waveform. An oscillogram characterized as "typical" is presented, as shown in Fig A24: it is a ring wave

with a frequency of about 800 kHz. In the data processing by conversion of the recorded events to a standardized trapezoidal pulse, the median of the time to half-value is found to be about 2  $\mu$ s, which is an indirect measure of the relatively short duration of the observed surges.

**A6.6 McEachern.** McEachern, in his *Handbook of Power Signatures* [B24], presents a general discussion of the many types of waveforms recorded by a new generation of instruments with built-in graphics capabilities. The data presented in this handbook are described as generic types, culled from a collection of 20 000 records collected over a period of two years. More than surges are described in the McEachern data; Figs A17 and A20 show typical surges selected by McEachern to illustrate two types of surges signatures (surges as defined in this recommended practice).

In addition to presenting data in the form of recordings, the McEachern handbook provides guidance on the procedures for conducting a survey of power-line disturbances and interpreting the results of the measurements, thus avoiding some of the interpretation and comparisons problems discussed in this appendix.

www.Lisungroup.com

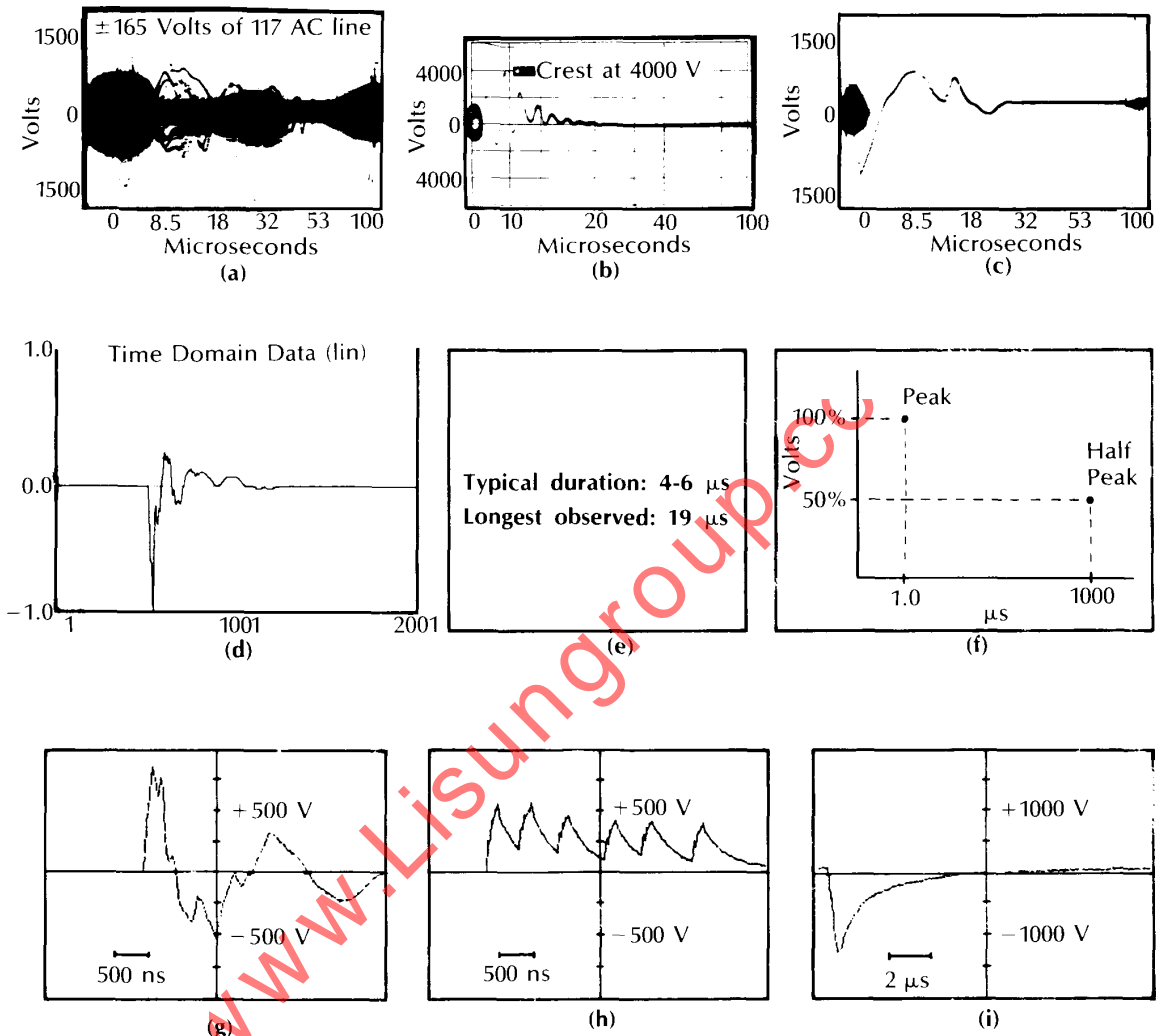

Source: Martzloff and Gruz [B61]

**Fig A24**  
**Comparison of Waveforms Reported in the Literature**

NOTE: "Typical" waveforms reported in site surveys. (a)-(c) Three examples of surges recorded by Martzloff. (d) Typical waveform according to Goedbloed. (e) Description of waveform by Cannova. (f) Description of waveform by Odenberg-Braskich. (g)-(i) Three examples of surges recorded by Wernström, Broms, and Boberg.

## Appendix B Additional Information

This appendix contains detailed explanations and historical perspectives of commonly used terms that are defined within this document or in IEEE Std 100-1980 [9]. There is also discussion of special considerations that may apply to situations encountered when using this document.

**B1. Amplitudes of Strikes.** The surge voltages described in this document include lightning effects on power systems, mostly strikes in the vicinity of a power line or at a remote point of the power system. The literature describes the frequency of occurrence versus amplitude of direct lightning strikes, from the low levels of a few kiloamperes through the median values of 20 kA (Cianos and Pierce, 1972 [B9]) to the exceptional values in excess of 100 kA (Standler, 1989 [B68]).

A lightning strike terminating on the conductors of an overhead secondary distribution system will seek a path to ground that involves more than one grounding point of the system. Fig B1 illustrates this situation, where a lightning strike of 100 kA is assumed to terminate on the primary conductors, with the arrester diverting this current to the multiple-grounded neutral conductor at the utility pole. The lightning current will divide into several paths to earth ground, as shown in the figure, according to the inverse of the impedance of each path of the parallel combination. The relative values shown in the figure are arbitrary and given merely to illustrate the concept; the level of 100 kA chosen for this example is based on the following analysis.

In their 1972 description of lightning environments, Cianos and Pierce [B9] indicate that only 5% of all ground strokes exceed a peak current of 100 kA. The frequency of strokes is quite dependent upon the geographic location (isokeraunic levels as well as the nature of the lightning cells, see section B8), and the point of termination also depends on local structures. An average expectation of a stroke involving the pole of the utility distribution circuit near a house with no adjacent tall trees or buildings may be in the order of one per 400 years for most of the United States. Thus, at a 5% probability for 100 kA, the likelihood of the

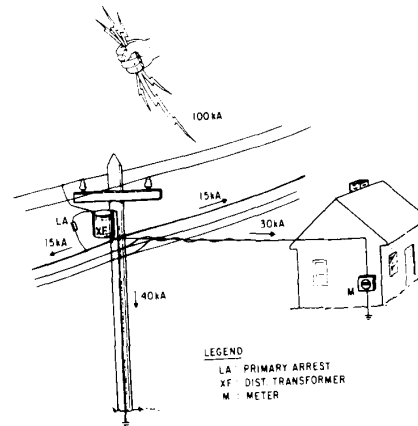

Source: Martzloff and Crouch [B41]

**Fig B1**  
**Division of Lightning Current Among**  
**Multiple Paths**

Fig B1 scenario at any one pole would be one time in 8 000 years—but there are millions of poles in the United States.

The laboratory simulation of the effect of such a lightning current flowing only in the ground conductors was reported by Martzloff and Crouch ([B41]), from which the data in A1.2 were obtained.

In that scenario, the effect of the lightning current in the ground conductor was to induce voltage surges in the adjacent phase conductors. Connecting a surge arrester at the service entrance of the building in Fig B1 would result in further current division by adding a path involving the phase conductors and their surge arresters.

Thus, a secondary arrester rated for 10 kA located at the service entrance of this building can be expected to handle the current from the phase conductors to the ground circuit of that building, while providing voltage clamping for the line-to-ground conductors of the branch circuits within the building. On the other hand, a direct strike to the phase conductors on the service drop—a rare occurrence—would produce higher currents.



The voltage and current amplitudes presented in the tables of Section 9 attempt to describe the effect of typical lightning strikes but should not be construed as "worst case," since the definition of what represents a worst case is open-ended and subjective (see section B25).

**B2. Amplitude Spectral Density.** Immunity of the electronic equipment will depend on the energy spectral density of the surge. At relatively low frequencies, there can be large transfer coupling losses between the surge and the disturbed circuits, but at higher frequencies these transfer losses become smaller. Thus, it may be important to suppress surges of small amplitude but large rate of change.

This class of surges is often characterized in the frequency domain. By the use of the Fourier transform, the amplitude spectral density can be found, as shown in Fig B2.

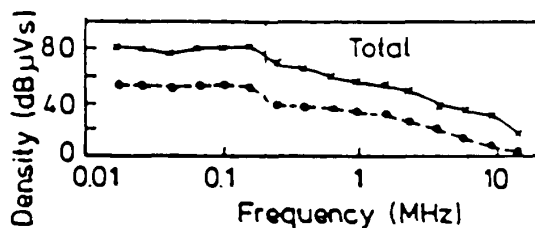

Source: Goedbloed [B14]

**Fig B2**  
**Amplitude Spectral Density for Total of**  
**Goedbloed Data**

Note that the spectrum is nearly flat up to 160 kHz and then decreases at 20 dB/decade. Furthermore, there is almost no significant component in the spectrum above 20 MHz. The use of this figure may be helpful in the design of power mains filters. Individual surges at individual sites having a specific ring frequency produce a peaked distribution of amplitude spectral density (Standler, 1989 [B68]). When many surges and sites are combined in a plot, the result is a broad and declining distribution. Thus, a distinction must be made between single events as they impact specific equipment having a specific frequency response and the composite result.

**B3. Changes in the Environment.** Prior to the proliferation of surge-protective devices in low-voltage systems, a limitation had already been recognized for peak voltages: the flashover of clearances, typically between 2 kV and 8 kV for low-voltage wiring devices. Literally millions of surge-protective devices, varistors in particular, have been installed in low-voltage ac power circuits since their introduction in 1972 (Martzloff, 1980 [B42]; Standler, 1989 [B68]). Therefore, a new limitation exists in surges that occur in this changing environment. Monitoring instruments are routinely installed to record the occurrence of surges at a site where a sensitive load is to be connected. The recording of the surges will be affected by the presence of a nearby surge-protective device. Close proximity of a surge-protective device to a recording instrument may impact present and future measurements in several ways, as contrasted to previous measurement campaigns. Four of these are outlined below.

- (1) Locations where voltage surges were previously identified—assuming no change in the source of the surges—are now likely to experience lower voltage surges, while current surges will occur in the newly installed protective devices.
- (2) Not only will the peaks of observed voltages be changed, but also their waveforms will be affected by the presence of nearby protective devices.
  - (a) If a surge-protective device is located between the source of the surge and the recording instrument, the instrument will record the clamping voltage of the protective device. This voltage will have lower peaks but longer time to half-peak than the original surge.
  - (b) If the instrument is located between the source of the surge and a surge-protective device, or if such a device is installed in a parallel branch circuit, the instrument will record the clamping voltage of the device, preceded by a fast transient corresponding to the inductive drop in the line feeding the surge current to the protective device.

- (c) If a surge-protective device is connected between line and neutral conductors and a surge impinges between line and neutral at the service entrance, a new situation is created. The line-to-neutral voltage is indeed clamped as intended; however, the inductive drop in the neutral conductor returning the surge current to the service entrance creates a fast transient voltage between the neutral and the grounding conductors at the point of connection of the surge-protective device and downstream points supplied by the same neutral. Because this transient will have a short duration, it may be enhanced by the transmission line effect between the neutral and grounding conductors if there is a high impedance between these two conductors at the line end.
- (3) The surge-voltage limitation function previously performed by flashover of clearances is now more likely to be assumed by the new surge-protective devices that are constantly being added to the systems.
- (4) These three situations produce a significant reduction in the mean of surge recordings of the total population of different locations as more surge-protective devices are installed. The upper limit, however, will still be the same for those locations where no surge-protective device has been installed. Focusing on the mean of voltage surges can create a false sense of security and incorrect description of the environment. Furthermore, the need for adequate surge-current handling capability of a proposed new surge-protective device might be underestimated if partial surge diversion is already being performed by a nearby device.

Another case of changing environment is that of large sensitive loads, for which a growing practice is to supply them with dedicated mains from the service entrance. This practice has two implications:

- While the load is being separated from internally generated surges, it is also

separated from the beneficial effects of the proliferating surge-protective devices on other branch circuits.

- A dedicated branch circuit provides a closer coupling to the Location Category B environment than would a distributed wiring system that would result in a Location Category A.

Furthermore, the monitoring device might contain surge-protective devices within its circuitry for self-protection. This arrangement may give incorrect data on the environment and the effect of the device.

**B4. Description Versus Specification.** Published documentation of fast transients is scarce; for instance, a 1964 paper by Hayter ("High Voltage Nanosecond Duration Power Line Transients," presented at the Tenth Tri-Service Conference on EMC) is not retrievable in the open literature. IEEE Std 518-1982 [10] cites one example of a "showering arc" but does not derive from this example a recommendation for a conducted fast transient test, unlike the revised SWC test in IEEE C37.90.1-1989 [6]. Thus, as discussed in section B6, it is the recommendation of the IEC to apply the EFT test to the equipment covered by the scope of IEC 801-4 (1988) [5] that provides the basis for adoption of that additional waveform in the present recommended practice.

The justification for this adoption is that equipment that passes the EFT test appears to perform with fewer occurrences of upset than equipment that does not pass the EFT test. This situation illustrates the basic approach to specifying surge tests: A test wave is applied to a device, not to demonstrate that it can survive any of the waves that it will encounter in nature, but only to demonstrate for the benefit of both manufacturer and purchaser that the device can survive an agreed-upon, simple, clean surge. By surviving the test surge, the inference is made, *subject to confirmation by field experience*, that the device has the capability to survive the wide variety of surges that it will encounter during its life in the real world. Test waves should not be misconstrued as representing the actual natural phenomena. (Martzloff, 1983 [B43]).

**B5. Differential Mode and Common Mode.** The terms "differential mode" (also "normal

mode”) and “common mode” have been avoided in this document because they may create confusion if applied to ac systems consisting of phase, neutral, and grounding conductors. Rather, the specific and unambiguous use of L-N, L-L, L-G, N-G, LL-G, and LN-G is recommended.

It is important to note the existence of two different practices in bonding the neutral and grounding conductors, resulting in different levels of surges involving the grounding conductor. In typical US practice, the neutral conductor is bonded to the grounding conductor at the service entrance, and both are bonded to the local building ground. Local building grounds can be the structural steel, metal piping, earth electrodes, etc., in a sequence of priorities defined by Section 250-81 of ANSI/NFPA 70-1990 [2].

In typical European practice, the grounding conductor, generally called “protective earth,” is bonded to the neutral and to an earth electrode only at the distribution transformer. This protective-earth conductor is then brought into the building without further bonding to the local grounds.

Thus, in the US practice, there cannot be any N-G surges at the service entrance. External N-G surges cannot propagate into the building. Conversion of L-N surges within the building, however, can produce N-G surges at the end of branch circuits (Martzloff and Gauper, 1986 [B44]). Internal load switching can also produce N-G surges (Standler, 1989 [B37]; Forti and Millanta, 1990 [B12]).

In the European practice with no neutral-ground bonding at the service entrance, external N-G surges can propagate into the building. This situation justifies the requirement of demonstrating higher surge-withstand capability in the “common mode” than in the “normal mode” specified by many IEC documents.

Returning to the discussion of common mode and differential modes, these two terms are often used to distinguish two kinds of signals that can propagate along a two-wire transmission line. These concepts are useful when the transmission line is balanced, for instance in telephone lines, in some data transmission lines, and in some instrumentation. An ac wiring system is not a balanced circuit and, therefore, the concepts associated with balanced circuits do not apply directly. A

brief review of the concepts will clarify the terminology (Standler, 1989 [B68]).

Notwithstanding the resolve to avoid the terms in the body of this recommended practice, an explanation of the terms may help in understanding the issues. Consider the circuit of Fig B3, where the voltages between each conductor and ground are denoted  $V_{hg}$  and  $V_{ng}$ . The differential-mode voltage,  $V_d$ , and the common-mode voltage,  $V_c$ , are:

$$V_d = V_{hg} - V_{ng} \quad (\text{Eq B1})$$

$$V_c = \frac{V_{hg} + V_{ng}}{2} \quad (\text{Eq B2})$$

These concepts of differential mode and common mode may be helpful in understanding the propagation of overvoltages on the single-phase mains. However, the situation is somewhat confused in typical US installations because the neutral conductor is connected to earth ground at the service panel, which destroys the balance of the line.

It is important to distinguish between the concept of balance and the concept of differential mode and common modes. When a balanced line is cut, the same impedance is observed between each of the two wires in each half cable, as shown in Fig B3. However, a transmission line does not need to be balanced to calculate the voltages  $V_c$  and  $V_d$ .

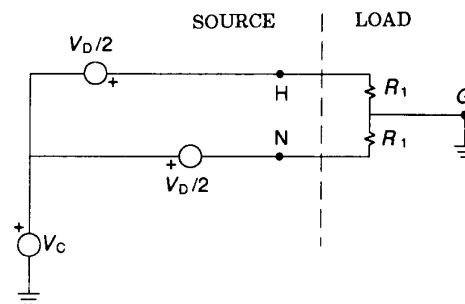

From *Protection of Electronic Circuits from Overvoltages* by Ronald B. Standler. Copyright © 1987 by John Wiley & Sons, Inc. Reprinted by permission.

**Fig B3**  
**Common Mode and Differential Mode in a**  
**Balanced Transmission Line**

**B6. EFT Test.** The EFT burst-test requirements of the IEC apply to all lines (“...either supply, signal, or control...”) for industrial process control equipment, which is the scope of IEC 801-4 (1988) [5]. In the present context, only the “supply lines” (the mains connection in the language of this recommended practice) are of interest. For these lines, according to IEC 801-4 (1988) [5], the pulses can be injected into the equipment by a coupling/decoupling network, (Fig B5) or by a coupling clamp (Fig B6) if the coupling/decoupling network cannot be used. Note the use of a coaxial cable for the connection from the test generator and the inference that the pulses are applied to one line at a time. In contrast, the coupling-clamp-method approach applies the test pulses simultaneously to all the ac line conductors of the EUT.

When using the coupling clamp, and if the ac mains connection cable includes a shield, the pulses are essentially applied to the shield and very little will be coupled to the conductor within the shield. This large difference in coupling reflects the intention of the test—evaluating the immunity to disturbances coupled from adjacent circuits. The coupling circuit acts then as a capacitance divider, the “high side” being the capacitance between the coupling clamp and the cable shield, the “low side” being the capacitance between the conductors contained within the shield and the grounded enclosure of the EUT (Fig B4). The high frequencies associated with the EFT pulse make the capacitive coupling more important than the other elements in the coupling circuit.

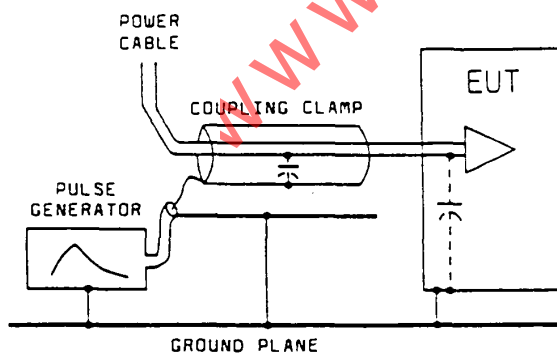

**Fig B4**  
**Capacitive Divider Effect in the EFT Test**

IEC 801-4 (1988) [5] also contains a clause suggesting that the more severe test condition produced by the direct capacitor coupling to the ac line conductors, rather than by the coupling clamp, can justify the negotiation of lower levels of severity than the 1 kV to 4 kV values specified for the open-circuit voltage of the generator when using the coupling clamp.

This situation makes even more important the distinction, made in 7.4.4, between the general concept of *describing* the ac surge environment and the adoption of a *test procedure*. Once again, the severity levels prescribed by IEC 801-4 (1988) [5] when using the coupling clamp should not be construed as implying that these levels of transients can be expected in the ac mains. In other words, the EFT burst does not *represent* the environment but is a test *justified* by the environment.

**B7. Energy Delivery Capability.** Recent surveys have addressed the issue of energy delivery capability in various manners. A distinction must be made between two aspects of the energy involved in a surge event: the energy available from the surge source and the energy delivered to the equipment (protective device or load equipment). The energy,  $W$ , delivered by the source for a surge having time boundaries of  $t_1$  and  $t_2$  is given by:

$$W = \int_{t_2}^{t_1} i(t) \cdot v(t) dt$$

$$= \int_{t_2}^{t_1} \frac{v^2(t)}{z(t)} dt \quad (\text{Eq B3})$$

where

- $i$  = The current from the source
- $v$  = The voltage across the source
- $z$  = The impedance,  $v/i$ , of the system connected to the source

The energy delivered to the equipment is determined by the source voltage and the impedance divider effect between the source and the equipment. Both the source impedance and the equipment impedance are a function of frequency.

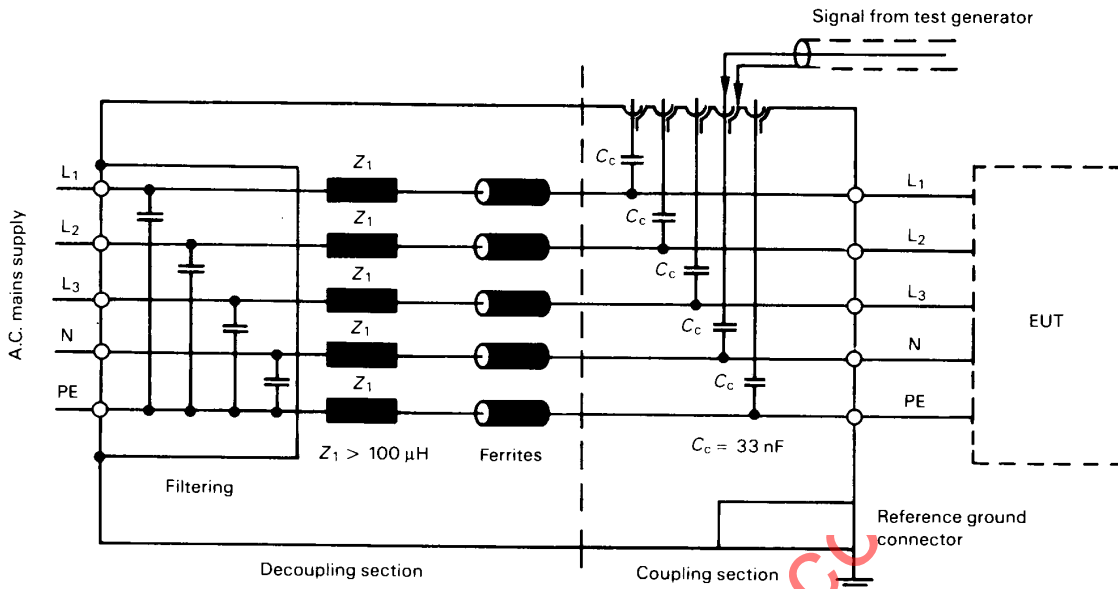

Source: IEC 801-4 (1988) [5]. Reproduced with permission of IEC, which retains the copyright.

**Fig B5**  
**Direct Coupling of EFT Pulses Into the AC Mains Connection of the EUT**

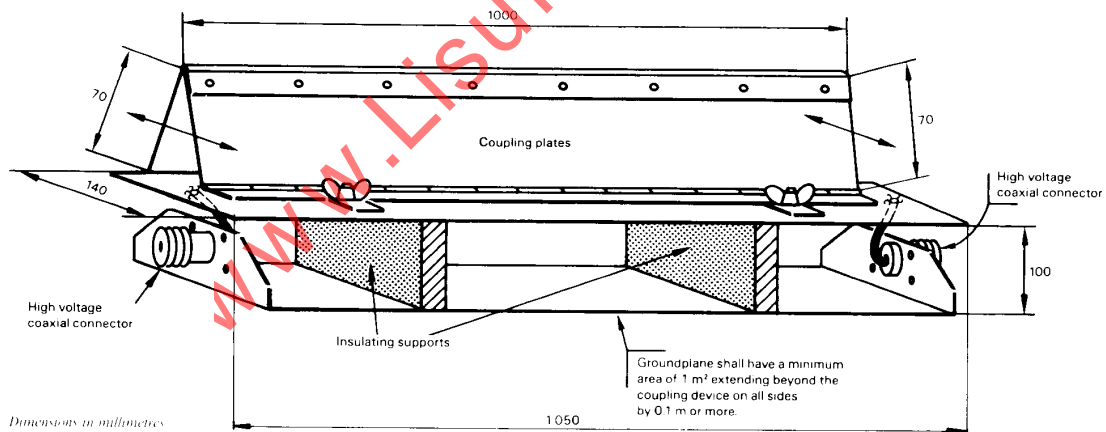

Source: IEC 801-4 (1988) [5]. Reproduced with permission of IEC, which retains the copyright.

**Fig B6**  
**Coupling Clamp for EFT Test**



The impedance of a clamping-type surge-protective device is, by its very nature, a strong function of the surge current. In recognition of this fact, Goedbloed, in his 1987 paper [B14] gave only

$$S = \int_{t_2}^{t_1} v^2(t) dt \quad (\text{Eq B4})$$

where

$S$  = The "energy measure"

At low frequencies (surges having a low rate of change of voltage) or for nonlinear surge-protective devices, the use of a constant, resistive source impedance is not justifiable (Standler, 1989 [B83]). Furthermore, the "energy in the surge" would be different from the energy deposited in a surge-protective device or a particular load. Thus, the concept of recording the "energy measure" may promote the arbitrary reporting of "surge energy" by assuming a value for the impedance and then quoting results in joules.

While there is definite merit in an attempt to describe the capability of a surge for delivering energy to circuit components, readers should realize that "energy" reports should be evaluated with a clear understanding of the underlying assumptions. As progress continues in the development of power system disturbance monitors, the data base should be expanded by making appropriate measurements of the surge current diverted by surge-protective devices installed at the point of monitoring (Standler, 1989 [B83]).

One should not confuse this energy database issue with that of the energy stored in a surge test generator. A surge generator can test the equipment energy-absorbing abilities and the effects of the deposition of energy in the equipment.

Furthermore, a distinction has to be made between surges of high amplitude but short duration and surges of high or moderate amplitude but longer duration. The first of these have the potential of upsetting equipment operation but can transfer little energy, while the second of these can transfer a large amount of energy to the surge-protective device or to the vulnerable equipment.

**B8. Expected Occurrence of Lightning.** Extensive data have been compiled by weather observers throughout the world regarding the annual incidence of thunderstorms. Reports were generally presented as isokeraunic maps showing the numbers of "thunderstorm days" (Figs 7 and 8). A thunderstorm day is defined as any day on which thunder is heard at a specific observation point. The isokeraunic level does not indicate the severity of the storm or the number of strokes to earth. Field studies (Trueblood and Sunde, 1949 [B33]) provided the statistical data to develop "stroke factors" related to the type of storms. The stroke factor is the number of strokes to ground per square mile per thunderstorm day.

Frontal thunderstorms, caused by the collision of a warm moist front with a cold front, may have durations of hours and occur over a large area of land. The stroke factor for frontal storms is 0.37. Convective thunderstorms are a result of local meteorological and topographical conditions. They are caused by the local heating of the air near the earth and are quickly dissipated by the accompanying rain. Since these storms are of short duration the incidence and magnitude of the strokes to ground is lower than for a frontal storm, yet they account for the majority of thunderstorm days. Quick afternoon thunderstorms during summer months are of this type. The stroke factor for a convective storm is 0.27.

Recent advances in weather studies have made possible the remote detection of cloud-to-ground lightning flashes over wide areas (Orville et al., 1987 [B29]). This new method of reporting lightning density, shown in Fig B7, provides finer detail on the characteristics of the flashes, as well as their precise geographical distribution, than the traditional isokeraunic maps.

For critical systems impacted by high lightning activity, this new information can provide the basis for specifying appropriate measures to deal with a high-energy surge environment, such as periodic inspection and replacement of surge-protective devices or exceptionally severe test requirements.

**B9. Failure Rate Observations.** A case history has been reported (Martzloff and Hahn, 1970 [B22]) of a high failure rate of clock motors in the early 1960s. The typical surge withstand



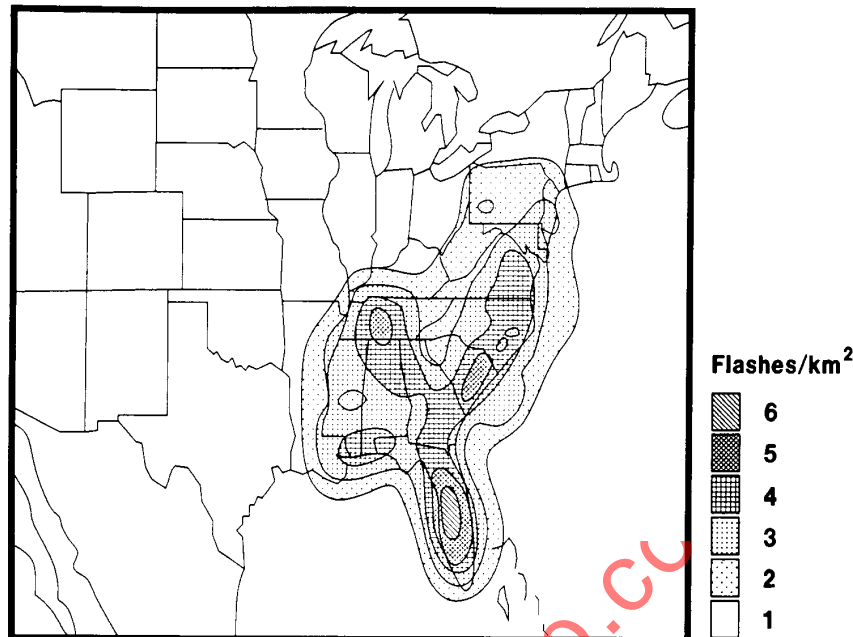

Source: Orville et al. [B29]. Copyright © 1989. Electric Power Research Institute. EPRI EL-6413. *Lightning Flash Characteristics: 1987*. Reprinted with permission.

**Fig B7**  
**Lightning Ground Flash Density, 1987**  
**(Data for Eastern United States Only)**

level of a particular design of clocks was only 2 kV, and their failure rate was unacceptable.

Subsequent redesign for 6 kV withstand produced a 100:1 reduction in the failure rate. Thus, the actual rate of occurrence of surges of 2 kV versus 6 kV can be inferred from this case history with a high degree of confidence because the number of clocks, acting as surge recorders, involved thousands of reported failures at 2 kV, versus the continued survival of thousands of motors of the new design.

There is uncertainty about the exact value of these two numbers, 2 kV and 6 kV, because the actual failure level of individual clocks at each of the two levels undoubtedly followed some statistical distribution. The ratio of failure rates, however, reflects the rate of occurrence between the two levels and indicates a significant rate of occurrence at 2 kV when monitoring is done year-round at thousands of locations—by clocks acting as “monitors”—against even the most extensive surveys

reported in the literature that involve only a few tens of monitors at most, for periods of time generally less than one year at each location.

Another type of “monitor” is the common incandescent lamp, involving billions of device-hours of exposure to the ac mains environment. The design of an incandescent lamp varies with several parameters determined by the manufacturer in each watt rating, but tests have shown that most designs result in a destructive flashover inside the lamp, occurring for surges as low as 1.1 kV, generally at 1.5 kV, (but not occurring in some designs having an inherent immunity, for reasons that have been either not identified or not published). The common experience of all consumers has been that incandescent lamps typically fail in three modes:

- (1) During current inrush associated with turn-on, after some aging;

- (2) At some undetermined time, the failure occurring without witness;
- (3) During normal operation of the bulb, with a bright flash.

This third failure mode has been observed often during lightning storms and occasionally without any obvious power system disturbance or mechanical shock applied to the lamp. Laboratory tests show that a surge on the power line can produce this third failure mode. This scenario of failure can readily explain the anecdotes of summer cottage experiences (long overhead lines), illustrating the definition of the "high exposure" or "extreme exposure" in this recommended practice.

Given the withstand levels stated above, the inference can be drawn that, at any one typical consumer premises, there is only a limited number of occurrences of surges above 1.2 kV; if there were many, the life expectancy of incandescent lamps would be seriously lowered below the manufacturer-stated life.

**B10. Installation Categories.** Subcommittee 28A of the International Electrotechnical Commission has prepared a report (IEC 664 (1980) [4]) in which "Installation Categories" are defined.<sup>1</sup> These installation categories divide power systems according to the location in the building, in a manner that appears similar to the location categories defined in this guide. However, there are some significant differences between the two concepts.

First, the IEC categories are defined for a "controlled voltage situation," a phrase that implies the presence of some surge suppression device or surge attenuation mechanism to reduce the voltage levels from one category to the next.

Second, the IEC publication is more concerned with insulation coordination than with the application of surge-protective devices; therefore, it does not address the question of the coordination of the protectors but, rather, the coordination of insulation levels, that is, voltages. Source impedances, in contrast to this recommended practice, have not been defined in the IEC publication. Fig B8 shows a comparison of the concepts.

---

<sup>1</sup>To be called "Overvoltage Categories" in subsequent updates of the IEC document.

**B11. Interface Devices.** A user of this recommended practice is primarily concerned with understanding the environment of the equipment at the location where it is intended to be used. This location is normally the attachment point of the equipment to the permanent premises wiring. Due to the recent proliferation of interface devices installed for surge protection, isolation, voltage regulation, and power continuity, this description at the end of the premises wiring may no longer completely encompass the actual use locations. It is for this reason that a more appropriate description should include the attachment of the equipment to such interface devices.

Surge events as described for Location Category A in this recommended practice can and do appear downstream of these interface devices. Commonly used isolation transformers provide decoupling or cancellation of neutral-to-ground surges if properly installed. However, they do not isolate or decouple line-to-line or line-to-neutral surges (Martzloff, 1983 [B43]). These surges will be passed unattenuated through isolation transformers. Surge events may also appear on the output of these interface devices through inductive coupling between conductors of flexible cords commonly used for connecting the devices. Wiring errors involving the neutral and ground conductors or the improper attachment of premises-wiring neutral conductors to the outputs of these devices are other mechanisms in which these surges are injected. Although impedances at these attachment points may differ from those of common premises wiring, data taken at these locations should be considered as a valuable addition to this recommended practice.

**B12. Level Versus Rate of Occurrence.** The relationship between the level and the rate of occurrence of surges is the result of several factors. The sources of disturbances tend to have fewer occurrences at higher levels. Another factor is the attenuation of the surges as they propagate away from the source of the surge and divide among paths beyond branching points. Equipment at a given point will be subjected to a relatively small number of high-level surges from nearby sources but to a larger number of surges from more remote sources.

Notes for Fig B8

- The voltage levels shown in the three location categories represent high-impedance circuit conditions: light loading and no surge-protective devices, P<sub>1</sub>, P<sub>2</sub>, P<sub>3</sub>, or P<sub>4</sub>. The 10 kV voltage of Category C is reduced to a maximum of 6 kV in both Categories B and A by the likely sparkover of clearances, should a 10 kV surge impinge on the service entrance.
- The current levels shown in the three location categories, in a descending staircase from C to A, represent low-impedance circuit conditions for surges, such as the installation of one or more surge-protective devices, P<sub>1</sub>, P<sub>2</sub>, P<sub>3</sub>, or P<sub>4</sub>. Another low-impedance condition is the case of equipment sparkover (installed equipment in an actual system or EUT during a test).
- If multiple surge-protective devices are installed on the system, the current waveform imposed on the downstream protective device is influenced by the clamping characteristics of the upstream device.

Typical examples and IEC 664 (1980) [4] concept notes:

- (1) The controlled voltage situation of IEC 664 (1980) [4] requires the presence of interfaces; these can be surge-protective devices, such as P<sub>1</sub>, P<sub>2</sub>, P<sub>3</sub>, or P<sub>4</sub>, or the existence of well-defined impedance networks, such as Z and C, shown in the circuit diagram upstream of WR<sub>2</sub>.  
Surge arresters or protectors P<sub>1</sub>, P<sub>2</sub>, P<sub>3</sub>, and P<sub>4</sub> may be any protective device suitable for the surge-current levels expected at that point of the system. P<sub>1</sub> and P<sub>2</sub> are shown connected line-to-ground. P<sub>3</sub> and P<sub>4</sub> may be connected line-to-neutral or be a combination of line-to-neutral with additional neutral-to-ground.  
Surge arrester P<sub>2</sub> may also be connected on the load side of the main circuit breaker (MB). In that case, MB would then be considered to be in Installation Category IV.
- (2) Voltage levels following the designation of an Installation Category (IV, III, II, or I) are shown in parentheses for a system with 300 V phase-to-ground voltage and outside of parentheses for 150 V phase-to-ground voltage. The voltages shown are implied as 1.2/50  $\mu$ s impulses.  
*Example:* IV (6)4 means 6 kV 1.2/50  $\mu$ s for a 240 V system; 4 kV 1.2/50  $\mu$ s for a 120 V system. See IEC 664 (1980) [4] for the complete table of levels corresponding to system voltages from 50–1000 V.
- (3) This diagram makes no allowance for the possibility of surges associated with ground potential differences that may occur, for instance, with a sensor connection to the ICS control system, a cable TV connection to the line-isolated TV set, etc., or the flow of ground current in the impedance of the grounding conductors.
- (4) Transient protector (P) in the line feeding the welder (AW) (a typical example of transient generator internal to the system) is intended to protect the system from the welder, rather than to protect the welder from the system.
- (5) Power-line conditioner (LC), while performing the major task of conditioning the power supply to the computer, might perform a function similar to that of the protector (P) at the welder in blocking conducted interference from the load toward the system.
- (6) Many appliances or electronic devices might be equipped with internal surge-protective devices and therefore be suitable for installation in other categories than II.
- (7) The use of the term *installation category* in Fig B8 and the text is based on IEC 664 (1980) [4]. This term will be supplanted by *overvoltage categories* in subsequent IEC publications.

CAUTION: Independent of its location in the above figure, a device or equipment should remain safe (no fires, no personnel hazard) over the full range of available surges at any point within the installation. It may also be desirable, under particular circumstances and for specific devices, to proscribe damage as a result of testing at higher levels than might be suggested by its typical location.

CONCEPT OF LOCATION CATEGORIES IN UNPROTECTED CIRCUITS

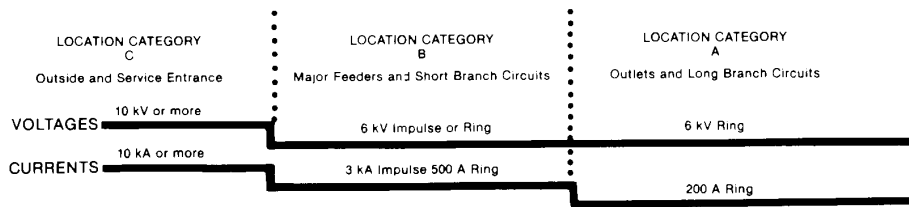

TYPICAL EXAMPLES OF INDUSTRIAL OR RESIDENTIAL CIRCUITS

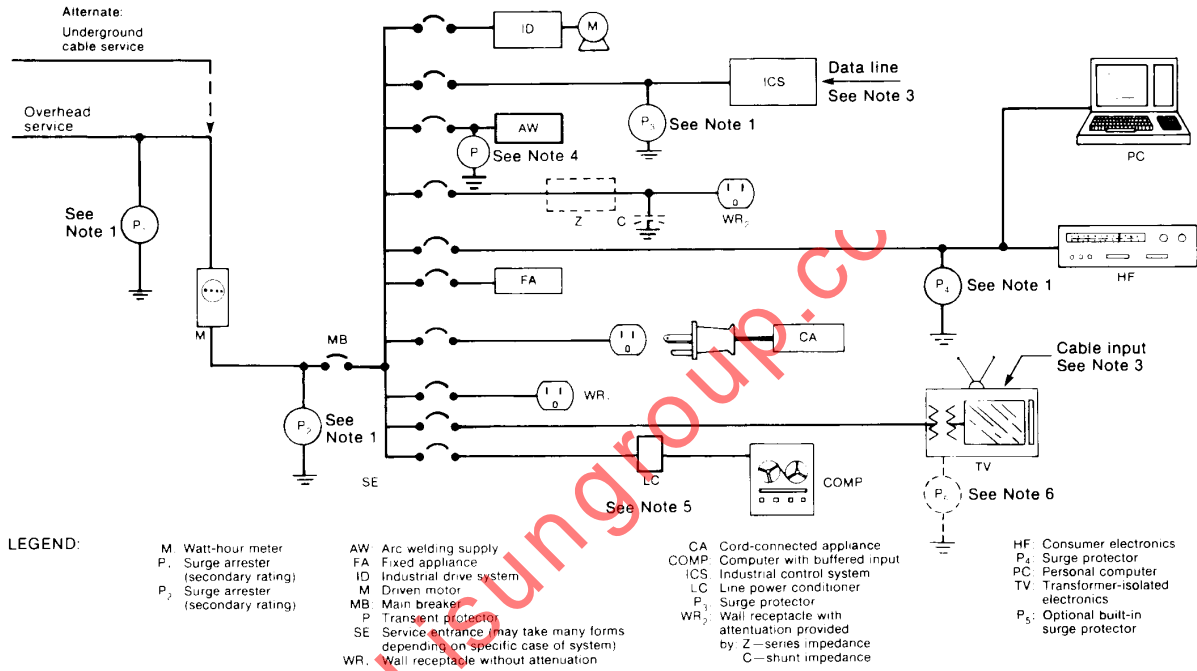

THE IEC PUB 664-1980 [17] CONCEPT OF CONTROLLED VOLTAGES

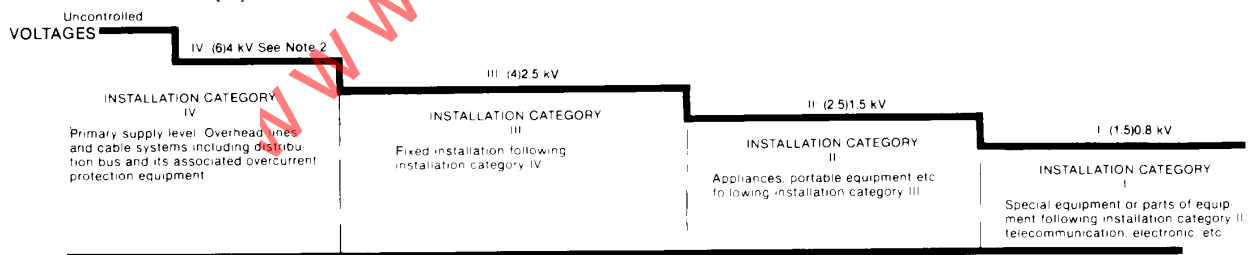

**Fig B8**  
Similarities and Differences Between the Location Categories Concept of This Recommended Practice and the Installation Categories of IEC 664 (1980) [4]

**B13. Low-Voltage System Oscillatory Surges During Lightning.** For the evaluation of power system equipment against lightning surges encompassing a wide spectrum of waveshapes, two standard test waves have evolved over the years: a 1.2/50  $\mu$ s voltage wave for insulation tests and an 8/20  $\mu$ s current wave for discharge-voltage tests of surge arresters. Evidence has been collected, however, to show that oscillations will occur in low-voltage power systems as a result of lightning discharges.

Lenz reports 50 lightning surges recorded in two locations, the highest at 5.6 kV, with frequencies ranging from 100 kHz to 500 kHz (Lenz, 1964 [B18]). Martzloff reports oscillatory lightning surges in a house during a multiple-stroke flash (Martzloff and Hahn, 1970 [B22]).

Other survey results, not necessarily involving lightning, also report oscillations. Goldstein and Speranza [B15] report oscillatory surges with frequencies between 3 kHz and 5 kHz and amplitudes reaching 2 kV. Goedbloed [B14] and Wernström et al. [B34] also report oscillations at high frequencies. Martzloff and Crouch [B41] report a test where a unidirectional surge current injected only in the ground conductor produced an oscillatory surge in the L-N mode inside the building.

**B14. Multiple Strokes and Total Energy.** The literature reports (Cianos and Pierce, 1972 [B9]; Golde, 1977 [B54]; Hasler and Lagadee, 1979 [B17]; Lenz, 1964 [B18]) that lightning flashes may consist of multiple strokes, with a total energy substantially larger than that of a single stroke. The current levels of the successive strokes of a multiple-stroke flash are generally lower than the first. The distribution of Fig 6, for unprotected locations, remains valid for the voltage levels of each strike of a multiple stroke. However, to apply a surge-protective device, one must consider the cumulative energy deposition of multiple strokes.

**B15. Open-Circuit Voltages and Wiring Sparkover.** Surges propagate with very little attenuation in a low-voltage power system when there are no substantial connected loads. Measurements made in a residential system as well as in a laboratory simulation (Martzloff and Crouch, 1978 [B41]) have shown

that the most significant limitations are produced by sparkover of the wiring devices, not by attenuation along the wires (Martzloff, 1983 [B43]). Ironically, a carefully insulated installation is likely to experience higher surge voltages than an installation where wiring sparkover occurs at low levels.

Therefore, the open-circuit voltage specified at the origin of a power system should be assumed to propagate unattenuated far into the system. This lack of attenuation is the reason for maintaining the 6 kV surge specification when going from Location Category B to Location Category A, notwithstanding the voltage staircase described by IEC 664 (1980) [4].

**B16. Per-Unit.** The amplitude of disturbances, including transient overvoltages, is often expressed in normalized form, which is called "per unit" in power engineering (IEEE Std 100-1988 [9]). If the amplitude of a disturbance is  $V$  volts, then the per-unit (pu) value is  $V/A$ , where  $A$  is the amplitude of the nominal mains voltage. For example, consider a disturbance with an amplitude of 250 V occurring on single-phase mains with a nominal mains voltage of 120 V rms: The per unit value is  $250/(120\sqrt{2})$  or "1.5 pu."

While the concept of per-unit is simple, there is a source of ambiguity. Does the "amplitude of the disturbance" include the instantaneous value of the mains voltage? Consider the two disturbances labeled A and B in Fig B9. The amplitude of the transient part is 70 V, which can be expressed as 0.41 pu. However, the peak value of A is 126 V (0.75 pu), whereas the peak value of B is 240 V (1.41 pu). This example shows that there can be different per-unit values associated with the amplitude of one transient disturbance.

Consider the disturbance labeled C in Fig B9. The amplitude of the transient part is 280 V or 1.65 pu. However, the peak value of C is 113 V or 0.67 pu. Yet another problem arises in the event labeled D in Fig B9. The amplitude of the transient part is 120 V, the first peak occurs at -49 V, the second peak occurs at -233 V.

In these examples, one could cite pu values of 0.71, 0.29, or 1.37. Here the largest magnitude of the voltage, 233 V, does not indicate the amplitude of the disturbance.

There is no easy resolution of the issue of whether or not to report the level of the transient disturbance independently from the

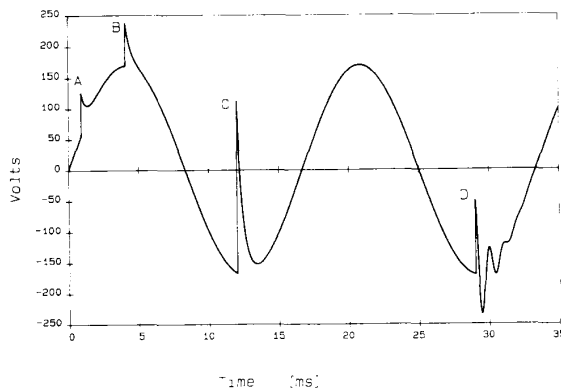

**Fig B9**  
**Effect of the Relative Polarity of Surges and Mains Voltage on Interpretation of "Per-Unit"**

normal mains waveform. Both practices are justifiable. However, the two practices give different values for the amplitude of the disturbance, and thus the meaning should be explicitly stated in reporting results of measurements (Martzloff and Gruzs, 1988 [B61]).

For large values of surges, such as thousands of volts on a 120 V system, and for the application of surge-protective devices of the clamping type having clamping-voltage values on the order of two to three times the peak of the power-frequency voltage, the distinction is not very important. However, concern has increased about possible adverse effects on equipment from surges with lower amplitudes, leading to a wish for tighter clamping voltages. In the case of low clamping voltages, the distinction becomes quite significant. The distinction is also important for the application of filters or surge-protective devices known as "tracking suppressors."

**B17. Power System Source Impedance.** The measurements from which Fig 6 was derived were of voltage only. Little was known about the impedance of the circuits upon which the measurements were made. Other measurements have been reported on the impedance of power systems.

Bull reports that the impedance of a power system, seen from the outlets, exhibits the characteristics of a 50  $\Omega$  resistor with 50  $\mu\text{H}$  in parallel (Bull, 1975 [B70]). At first, attempts

were made to combine the observed 6 kV open-circuit voltage with the assumption of a 50  $\Omega$ , 50  $\mu\text{H}$  impedance. This combination resulted in low energy-deposition capability, which was contradicted by field experience of suppressor performance. The problem led, in the 1980 edition of this document, to the proposed definition of 100 kHz oscillatory waves, as well as high-energy unidirectional waves (now identified as the two standard waveforms), in order to provide both the effects of an oscillatory wave and the high energy-deposition capability associated with unidirectional waves. It also led to a deeper understanding of the significance of clearance sparkover in limiting the observed voltages that result from current-source surges.

**B18. Sparkover of Clearances.** Sparkover, as defined in IEEE Std 100-1988 [9], has both a general meaning and a meaning that pertains to surge arresters. In the context of this recommended practice, sparkover is to be understood as a controlled, desirable function, as well as the unplanned arcing between live parts that is not intended but that performs a voltage-limiting function when it does occur. When sparkover of a clearance occurs, there are three possible results:

- (1) A follow current occurs, with destructive effects on the components.
- (2) A follow current occurs, but overcurrent protection (circuit breaker or fuse) limits the damage. The system can be restored to operation after a mere nuisance interruption.
- (3) No follow current takes place; the over-voltage protective function of the system can be considered as accomplished.

**B19. Surge Impedance and Source Impedance.** To prevent confusion or misunderstanding, a distinction between source impedance and surge impedance needs to be made. Surge impedance, also called characteristic impedance, is a concept relating the parameters of a line to the propagation of traveling waves. For the wiring practices of the ac power circuits discussed here, this characteristic impedance would be in the range of 100  $\Omega$  to 300  $\Omega$ , but because the durations of the waves being discussed on the order of microseconds are much longer than the travel times in the



wiring systems being considered, traveling wave analyses are not useful here.

Source impedance, defined as “the impedance presented by a source of energy to the input terminals of a device or network” (IEEE Std 100-1988) [9], is a more useful concept here. In the conventional Thévenin’s description, the open-circuit voltage (at the terminals of the network or test generator) and the source impedance (of the surge source or test generator) are sufficient to calculate the short-circuit current.

The previous edition of this document defined Location Category A as being branch circuits with wire gauge between AWG 14 and AWG 10 (diameter between 1.6 and 2.6 mm) and having a length placing them at least 10 m away from Category B and at least 20 m away from Category C. The present edition of this document does not recognize any relationship between diameter of wire and amplitude of surge. The reason is that the wire diameter has a minor effect, compared to length (Martzloff and Gauper, 1986 [B44]).

When a surge current,  $I$ , travels down a conductor, a voltage drop  $L(dI/dt)$  is produced by the inductance,  $L$ , of the wire, decreasing the surge current in the circuit. While larger diameter wires will have less inductance per unit length, it is not possible to readily estimate the relative values of  $L(dI/dt)$ , since the smaller inductance may allow a larger value of  $I$  and  $dI/dt$ .

The inductance per unit length at low frequencies of two parallel cylindrical conductors of radius  $a$ , whose centers are separated by a distance  $d$ , is given by:

$$L = \left( 0.4 \frac{\mu\text{H}}{\text{m}} \right) \ln \left[ \frac{d}{a} - 1 \right] \quad (\text{Eq B5})$$

The logarithmic dependence of inductance per unit length makes the inductance essentially independent of diameter of the wire over the range of commonly used wire gauges. At high frequencies the situation is complicated by the skin effect, but the inductance still depends on the logarithm of the diameter.

International standards on electromagnetic emissions also do not recognize any difference in impedance of the mains with changes in wire diameter. They specify an artificial

mains network that does not take wire size into consideration.

**B20. Surge Voltage.** Definitions of terms in this recommended practice are consistent with IEEE Std 100-1988, [9]. However, some differences exist. For instance, IEEE Std 100-1988 [9] defines a surge as a “transient wave of current, potential or power in the electric circuit”—a definition broader than that used here. Transient overvoltage is defined in IEEE Std 100-1988 [9] as “the peak voltage during the transient condition resulting from the operation of a switching device”—a definition more restrictive than that of the present recommended practice, which deals with surge voltages from all sources.

**B21. Switching Surges.** The switching surges represented by the additional waveforms can occur under a wide range of conditions, which makes it difficult to assign universally applicable severity levels for test purposes. Hence, the levels suggested in Section 10 are an attempt at striking a balance between a wish to provide conservative ratings and the reality that countless instances of successful operation are observed for equipment that does not have the capability of withstanding the severity of the suggested levels.

The 5 kHz waveform has been suggested as typical of capacitor switching transients. Frequencies can be much lower, as low as 350 Hz. The ampere levels associated with a capacitor switching surge can vary significantly and depend on a number of factors, including: the type of switching device (and corresponding probability of prestrikes, restrikes, or re-ignitions), the grounding situation, the system inductance, the kVAR size of the bank, and how often the bank is switched. Any nearby capacitor bank should be analyzed on a case-by-case basis. Common practice in the electric utility industry is to size the arrester to handle a single worst-case restrike.

**B22. Timing of Surges With Respect to Power Frequency.** Lightning surges are completely random with respect to the power frequency. Switching surges are likely to occur at or near current zero, but variations in the power factors of the loads will produce a quasi-random distribution.

Some semiconductors exhibit failure levels that depend on the timing of the surge with respect to the conduction of power frequency current (Chowdhuri, 1973 [B38]). Gaps or other devices that produce follow current may or may not withstand this follow current, depending on the fraction of the half-cycle remaining after the surge, before the power-frequency current zero.

Therefore, it is important to consider the timing of the surge with respect to the power frequency. In performing tests, either complete randomization or controlled timing should be specified, with a sufficient number of timing conditions to reveal the most critical timing.

**B23. Utilities Interconnections and Interactions.** Limiting the scope of the surge-environment description to ac power circuits may leave unrecognized a surge-producing mechanism that involves interactions between the mains and data-carrying conductors, the latter being excluded from the scope of this recommended practice. For this reason, it is important to consider the proximity of the conductors of the mains and of the data systems (a telephone, a computer network, a cable TV) within a building.

Ground connection practices for the surge-protective devices provided in these separate systems can result in unexpected voltage differences between the systems during surge events on one system. These voltage differences can occur even though each utility would be observing its mandated practices. Furthermore, these various systems and their functional elements may contain built-in surge protection that can result in side effects (Martzloff, 1990 [B48]).

To illustrate these important considerations, Fig B10 shows in a schematic manner a typical building with an electric utility connection and a telephone utility connection in an attempt to detail the real-life complex wiring that may exist at a typical residence or business. Note that the drawing depicts primary and secondary electric-power wiring circuitry, including feeder and branch circuits within the premises. The drawing also depicts telephone utility wiring facilities outside the premises and the drop wiring arrangements to provide communications service within the premises.

The drawing could be made much busier by adding circuits from cable television systems, premises satellite TV systems, local area communications networks, lightning protection systems, or other similar types of wiring.

The drawing also shows the relative vicinity of Location Categories A, B, and C in this example. Equipment connected to wiring within the boundaries of Category A could conceivably be placed in close proximity (the distance between printed circuit-board traces) with wiring from either Category B or C. An example would be a computer that is connected to its ac power source deep within the premises (relative to the service entrance), but with its telephone modem connected to an aerial telephone circuit located a short distance away on the other side of the premises wall.

The grounding provisions of the different wiring systems are of special note because they are expected to handle surges and are often designated paths for surge diverters. Grounding provisions of separate wiring systems may conduct surges of opposite polarity and thus bring together extreme surge voltages within the confines of electronic equipment cabinets.

Therefore, in making decisions on how to design electronic equipment, the designer needs to recognize the real-world possibilities of bringing together in extremely close proximity two or more wiring systems (from possibly different wiring categories). Designs should include separations and/or surge-withstand capability appropriate for the convergence of such diverse multiple wiring systems. When making decisions on how and where to install electronic equipment and to provide for the most effective protection from the expected surge environment, the decision maker must have a clear concept of actual wiring and the relative proximity and intermixing of wiring category types.

The overall protection scheme decided upon should also include some type of ongoing program to ensure that the conditions existing at the installation phase are maintained and not otherwise allowed to deteriorate outside design parameters. A review of accepted practices is summarized below.

**B23.1 AC Power Service.** The surge protection for this service may include an overall protection at the service entrance and/or individual protection for branch circuits. There is

also the protection typically provided by surge arresters on the primary of the distribution transformer. This arrester is beyond the control of the end user but does provide protection of the distribution transformer and, to some degree, for the user on the secondary side, against the surges occurring in the utility system.

Overall protection at the service entrance may be provided at the weather head, at the watt-hour meter, or on the load side of the main service disconnect. In the United States, ANSI/NFPA 70-1990 [2] requires that, where used at a point of a circuit, a surge arrester shall be connected to each ungrounded conductor, and on circuits of less than 1 000 V the rating of the surge arrester must be equal to or greater than the maximum continuous phase-to-ground power-frequency voltage available at the point of application.

The user may provide supplemental transient-voltage surge suppression as deemed necessary to protect equipment against disturbances originating from user-owned equipment within the premises or from elsewhere. This type of additional ac power-line protection may be installed in any or all of the following locations:

- (1) Load side of entrance distribution panel
- (2) Branch system distribution panel supplied from a feeder
- (3) Individual branch receptacles (incorporated to the receptacle)
- (4) Plugged in the receptacle, as a removable device

Appropriate coordination of branch-outlet protective devices with service entrance protection could provide optimal protection from externally generated surges. Unfortunately, little information is available to the purchasers of these devices to assist them in obtaining such a coordination.

**B23.2 Telephone Station Protector.** Telephone companies install telephone surge protection as required by ANSI/NFPA 70-1990 [2] (the NEC) at the premises of the customer to limit abnormal voltages between telephone conductors and ground. This protection is required by the NEC [2] where the serving telephone circuits (aerial or underground) are so located within the block containing the building served as to be exposed to accidental con-

tact with electric light or power conductors operating over 300 V to ground or where serving telephone circuits are partly or entirely aerial and are not confined within a "block." A block is defined by the NEC [2] as a square or portion of section of a town, city, or village that is enclosed by streets and including the alleys so enclosed but not any street.

The communications circuit protectors may be carbon blocks, gas tubes or solid-state devices. They offer the protection that is required by the NEC [2]. These devices may be mounted inside or outside the premises of the customer.

Many equipment manufacturers and vendors incorporate additional protection in their system designs to limit undesired voltages. The NEC [2] has classified the arrester equipment providing such additional surge protection as "secondary protectors." The NEC [2] requires secondary protectors (Section 800-32 of the NEC [2]) to limit currents safely to less than the current-carrying capacity of the listed indoor communications wire and cable, the listed telephone set line-cords, and the listed communications terminal equipment having ports for external wire-line communications circuits. This current-limiting requirement was established because of the lower surge-arresting threshold available with secondary protectors and their likelihood of responding before, or at voltages below that of, the protector provided by the telephone utility and their initiation of current flow into the premises via the telephone circuit wiring.

Telephone utility-type station protectors and secondary protectors (whether separate, self-enclosed, add-on pieces of equipment or secondary protection incorporated within other products users may connect to the telephone network) must be "listed" in accordance with NEC [2] requirements. Listed means that the product is included in a document published by an organization acceptable to the authority (state, county, etc.) that mandates NEC [2] compliance. The "listing organization" has to be concerned with product evaluation and must maintain periodic inspection of production of the listed equipment.

**B24. VDE 0160 [B94] High-Energy Test.** Surges associated with the operation of current-limiting fuses have been discussed under 7.4.3 and 10.1. These long-duration, high-energy surges have been described by several

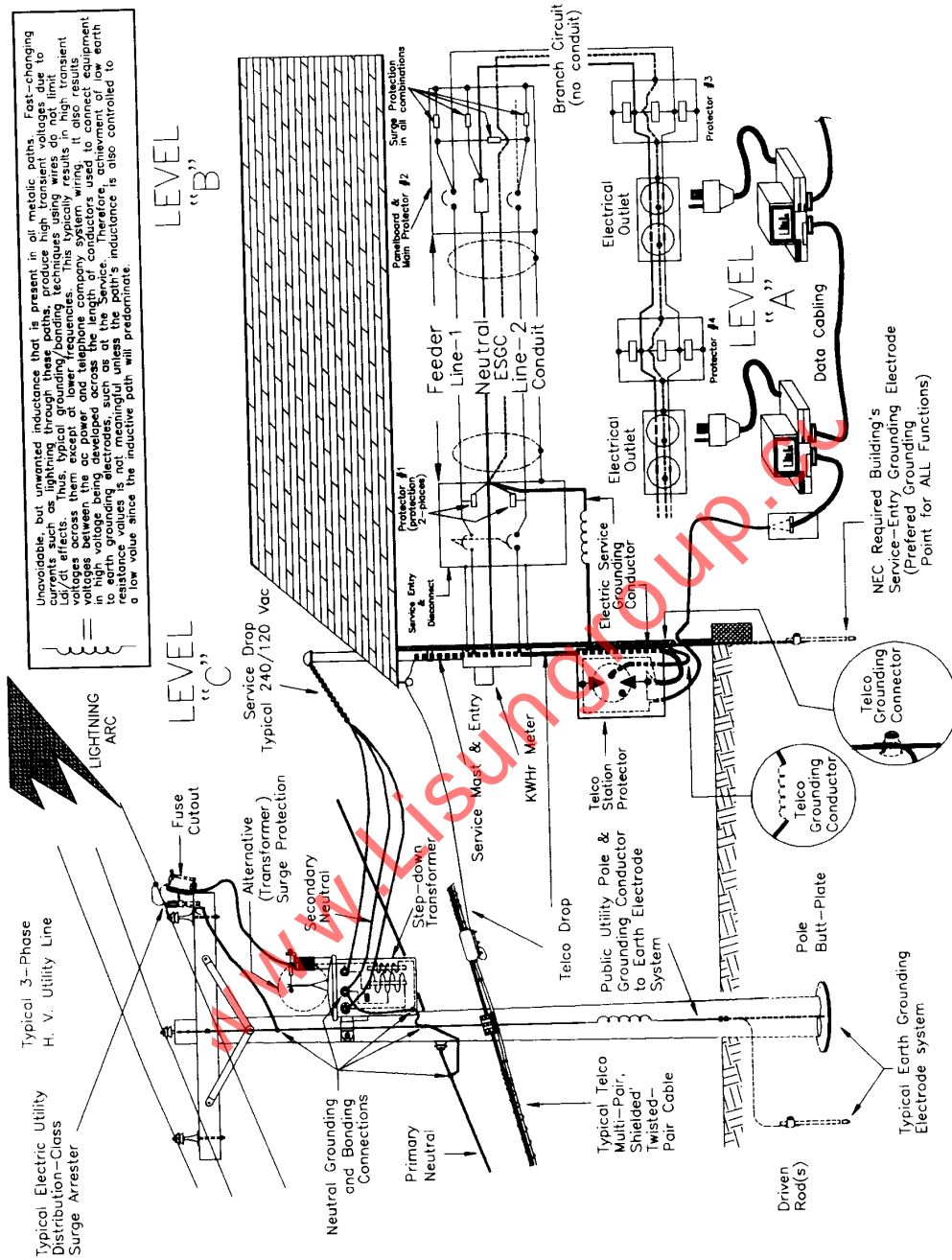

Unavoidable, but unwanted inductance that is present in all metallic paths. Fast-changing currents such as lightning air surges produce high transient voltages due to inductance. These high transient voltages are not limited by the resistance of the conductors used to connect equipment to service voltage, such as at the Service. Therefore, achievement of low earth to service voltage is not meaningful unless the path's inductance is also controlled to a low value since the inductive path will predominate.

**Fig B10**  
**Example of Interconnection and Interaction of Utilities for Typical US Practice**

researchers and organizations, as summarized in section A2.

One method of applying these surges is described in VDE Standard 0160 [B94], from which Figs B11 and B12 are excerpted. That standard mentions the use of a capacitor discharge through a low-resistance, pulse-shaping network. The specified voltage for charging the capacitor is 2.3 times the peak value of the mains voltage for a 100/1300  $\mu$ s waveform or a 100/600  $\mu$ s waveform (Fig B11).

The latest amendments of this standard specify the capacitor as ranging from 700  $\mu$ F to 6000  $\mu$ F, depending on the system voltage and the "class" of equipment. Fig B12 shows the limits of profiles of the duration versus amplitude for the two surges, and Table B1 shows the values of the capacitance for the two classes and several system voltages (no 120 V system voltage is shown in European-oriented standards).

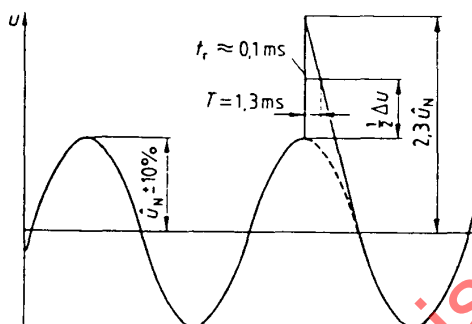

Source: VDE 0160 [B94]

**Figure B11**  
**Waveform and Phase Position of the**  
**100/1300  $\mu$ s Surge of VDE 0160 [B94]**

The two classes, Class 1 and Class 2, are defined in the standard on the basis of several parameters not necessarily known to the user and most likely unknown to the manufacturer of equipment: presence of other loads or other surge-protective devices (that may absorb some of the trapped energy), rating of the fuse involved (35 A is a transition point, less than 35 A being less severe), and several assumptions on the likelihood of short circuits occurring at various points of the system.

**Table B1**

**Capacitance Value Specified for the Test Generator, According to the System Voltage and the Equipment Class**

System Voltage	Capacitance for Test	
	Class 1	Class 2
220 V	$\leq 1\,400\ \mu\text{F}$	$\leq 6\,000\ \mu\text{F}$
380 V	$\leq 1\,400\ \mu\text{F}$	$\leq 6\,000\ \mu\text{F}$
500 V	$\leq 1\,200\ \mu\text{F}$	$\leq 5\,000\ \mu\text{F}$
660 V	$\leq 700\ \mu\text{F}$	$\leq 3\,000\ \mu\text{F}$

Source: VDE 0160, May 1989 amendment

In view of the evolutionary status of the VDE 0160 standard [B94], (which is being considered by several of the IEC Technical Committees) and of the complex set of conditions defining the differences between Classes 1 and 2, it would be premature to recommend the circuit parameters and test conditions as firm and definitive. Nevertheless, this standard development needs to be recognized. In particular, the effects on clamp-type surge-protective devices should be considered, especially for those with limited current-handling capability, for which the 2.3 X peak of the mains voltage may be too close to their clamping voltage (Martzloff and Leedy, 1989 [B46]; Fenimore and Martzloff, 1990 [B73])—or even above their clamping voltage (UL 1449-1988 [B91]). Manufacturers, users, and other interested parties involved in jurisdictions where compliance with VDE 0160 standard [B94] is required should refer to the current version of that standard.

**B25. Worst Case.** Voltage and current amplitudes appearing in the tables of Sections 8, 9, and 10 are given in an attempt to describe typical occurrences at various levels of severity. As stated in section B12 and discussed in Section 6, one can expect an inverse relationship between levels and rate of occurrence, hence the slopes in the exposure bands of Fig 6.

In the case of lightning strikes, one should think in terms of the statistical distribution of strikes, accepting a reasonable upper limit for most cases (Bodley et al., 1976 [B54]; Goldstein and Speranza, 1984 [B15]; Martzloff and Gruzs, 1988 [B61]; Standler, 1989 [B68]). Where the consequences of a failure are not catastrophic but merely represent an economic loss,



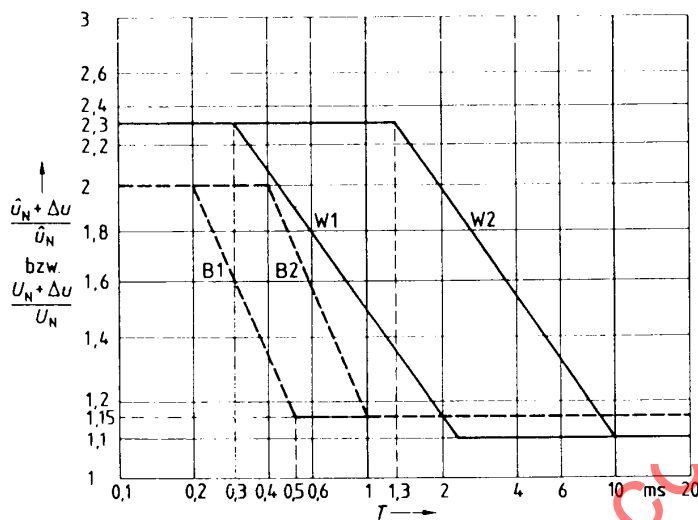

Source: VDE 0160 [B94]

**Legend:**

- T: Full-width at half-maximum of surge
- W1: Reduction in amplitude when duration exceeds 1300  $\mu$ s for Class 1 equipment
- W2: Reduction in amplitude when duration exceeds 300  $\mu$ s for Class 2 equipment
- B1, B2: Graphs applicable to battery-powered systems

**Figure B12**  
**Duration-Amplitude Profile for the "100/1300"  $\mu$ s VDE 0160 [B94] Surge**

it may be appropriate to make a tradeoff of the cost of protection against the likelihood of a failure caused by a high but rare surge. For instance, a manufacturer may be concerned with nationwide failure rates at high surge levels, those at the upper limits of the distribution curve (see Fig 10), while the user of a specific system may be concerned with a single failure occurring at a specific location under "worst case conditions." Rates of occurrence can be estimated for average systems, however, and even if imprecise, they provide manufacturers and users with guidance.

In the case of capacitor switching surges, there is a wide range of possibilities from benign to potentially destructive surges (see section B21). In the case of surges caused by the operation of fuses, the situation is similar, leaving the definition of "worst case" open to

debate, depending on the assumptions made for the circuit parameter.

This recommended practice has repeatedly emphasized that setting specific surge withstand levels remains the prerogative and responsibility of manufacturers in response to the needs of specific applications or user requirements. The temptation to seek assurance of high reliability by requiring "worst case" capability (with the pitfall of testing only at that level, missing the issue of blind spots) must be tempered by economic realities, which depend on the nature of the equipment and its use.

One approach is to select a level (and only one) of withstand capability for a type of equipment. That level would cover a high percentage of the applications; the addition of some add-on interface device would provide



for the small percentage of the cases of extreme ("worst case") environments. This approach is reflected in the exposure bands of Fig 6, where the exposure bands have imprecise limits. Another approach is to design the equipment after selecting a level of withstand

capability below which it will not be allowed to malfunction. A second, higher level is then selected, below which the equipment may be allowed to malfunction or even fail, but up to which it is not allowed to cause personnel hazard or consequential damage.

[www.Lisungroup.cc](http://www.Lisungroup.cc)

## Appendix C Annotated Bibliography

### C1. Bibliographic Information About References

The references listed in Section 3 provide information that complements this recommended practice. In this section of this appendix, a brief description is given of the contents of those references. Other related standards, but not considered as references, are listed in Section 6 of this appendix. The number of references given in these papers, as well as the inclusion of any formal discussion, are also cited in the comments of this appendix.

- [1] ANSI C84.1-1989, American National Standard Voltage Ratings for Electric Power Systems and Equipment (60 Hz).
  - Defines limits of system voltages for the United States.
  - Addresses only steady-state voltages or short-term departures from nominal conditions.
  - Provides list of related standards with address of sponsor.
  
- [2] ANSI/NFPA 70-1990, National Electrical Code.
  - A fundamental document providing minimum requirements for safe installation practices. A companion handbook provides explanations for application of the code.
  - Updated every three years.
  
- [3] *IEC Multilingual Dictionary of Electricity*. The Institute of Electrical and Electronic Engineers, 1983.
  - A conversion of the IEC International Electrotechnical Vocabulary (IEV) into a dictionary.
  
- [4] IEC 664 (1980), Insulation Coordination Within Low-Voltage Systems Including Clearances and Creepage Distances for Equipment.
  - Introduces the staircase concept of surge voltage reduction.
  - Does not discuss source-impedance considerations; concerned with insulation withstand, i.e., a high-impedance parameter.
  
- [5] IEC 801-4 (1988), Electromagnetic Compatibility for Industrial Process Measurement and Control Equipment—Part Four: Electrical Fast Transient/Burst Requirements.
  - Specifies interference immunity test with bursts of fast-transient pulses applied to EUT in “common mode” by a coupling clamp or in selective mode by capacitor coupling.
  
- [6] IEEE C37.90.1-1989, IEEE Standard Surge Withstand Capability (SWC) Tests for Protective Relays and Relay Systems.
  - A document developed for the environment of high-voltage substation equipment. Its fast-transient requirement, with a rise time of less than 10 ns, is similar to the IEC EFT burst requirement.
  - Calls for: -1 MHz to 1.5 MHz ring wave  
                   -4 kV to 5 kV peak impulse, < 10 ns rise time
  - 14 references

- [7] IEEE C62.1-1984, IEEE Standard for Surge Arresters for AC Power Circuits.
  - Specifies surge-current capabilities, in particular a 4/10  $\mu$ s current waveform for high-current tests, instead of the 8/20  $\mu$ s waveform of the Combination Wave.
  - 8 references
- [8] IEEE C62.45-1987, IEEE Guide on Surge Testing for Equipment Connected to Low-Voltage AC Power Circuits.
  - Basic tutorial on surge-testing procedures and an essential complement to this recommended practice.
  - 43 references
- [9] IEEE Std 100-1988, IEEE Standard Dictionary of Electrical and Electronic Terms.
  - Basic dictionary containing definitions developed by all working groups of the IEEE. New definitions developed during preparation of standards, such as listed under Section 4 of this recommended practice, will appear in the next edition of that standard.
- [10] IEEE Std 518-1982, IEEE Guide for the Installation of Electrical Equipment to Minimize Noise Inputs to Controllers from External Sources.
  - Discusses the sources of electrical noise; provides one example of the “showering arc” cited in the data base in support of the additional fast transient.
  - Provides guidance on noise reduction (not suppression) and installation practices.

## C2. Recorded Occurrences and Computed Simulations

- [B1] AIEE Committee Report. “Switching Surges—1—Phase to Ground Switching Voltages.” *AIEE Transactions*, PAS-80, June 1961, pp. 240–261.
  - Comprehensive report, 1961 vintage, of the subject.
  - 84 references, 10 discussions
- [B2] Allen, G. W. and Segall, D. “Monitoring of Computer Installation for Line Disturbances.” Presented at the IEEE Power Engineering Society Winter Meeting, New York, NY, Jan. 1974, Paper C74199-6.
  - 7 references, 1 (unpublished) discussion
  - See sections A3 and A5 for a more detailed review of this paper.
  - See Fig A23 in this recommended practice.
- [B3] Aspnes, J. D., Evans, B. W., and Merritt, R. P. “Rural Alaska Electric Power Quality.” *IEEE Transactions*, PAS-104, No. 3, March 1985, pp. 608–618.
  - Survey with disturbance recorders.
  - 28 references, 2 discussions
  - See section A3 for a more detailed review of this paper.
- [B4] Bachman, L., Gullberg, M., Strickler, F., and Sachs, H. “An Assessment of Shipboard Power Line Transients.” *Proceedings, International IEEE EMC Symposium*, Aug. 1981, pp. 213–218.
  - Surge recordings with storage oscilloscope and disturbance analyzers.

- [B5] Boehne, E. W. and Low, S. S. "Shunt Capacitor Energization with Vacuum Interrupters—A Possible Source of Overvoltage." *IEEE Transactions*, PAS-88, No. 9, Sept. 1969, pp. 1424–1423.
- Field tests and computer analysis for overvoltages on transformers and arresters, with proposed corrective measures.
  - 15 references, 11 discussions
- [B6] Bull, J. H., and Nethercot, W. "The Frequency of Occurrence and the Magnitude of Short Duration Transients in Low-Voltage Supply Mains." *The Radio and Electronic Engineer*, Sept. 1964, pp. 185–190.
- Peak-reading recordings at substations, bus-bars, and users.
  - 5 references
  - See section A3 for a more detailed review of this paper.
- [B7] Cannova, S. F. "Short-Time Voltage Transients in Shipboard Electrical Systems." *IEEE Transactions*, IA-9, No. 5, Sept./Oct. 1973, pp. 533–538.
- Oscilloscope recordings and histograms.
  - 18 references
  - See section A3 for a more detailed review of this paper.
- [B8] Chowdhuri, P. "Estimation of Flashover Rates of Overhead Power Distribution Lines by Lightning Strokes to Nearby Ground." *IEEE Transactions*, PWRD-4, No. 3, July 1989, pp. 1982–1987.
- Computation of flashover rates as a function of BIL.
  - 18 references, 1 discussion
- [B9] Cianos, N. and Pierce, E. T. *A Ground-Lightning Environment for Engineering Usage*. Stanford Research Institute, Menlo Park, CA, Aug. 1972.
- Comprehensive statistics on the characteristics of lightning.
  - 108 references, 136 pages
- [B10] Darveniza, M. and Uman, M. A. "Research Into Lightning Protection of Distribution Systems—Part II, Results from Florida Field Work 1978 and 1979." *IEEE Transactions*, PAS-103, No. 4, 1984, pp. 673–683.
- Statistics on the occurrence of lightning.
  - 14 references
- [B11] Dugan, R. G. "Conduction of Lightning Stroke Currents from the Utility System to Load Devices." *Proceedings, First International Power Quality Conference*, Oct. 1989.
- Discusses mechanisms for coupling surges between the grounding conductors and the line conductors during flow of lightning currents.
  - Describes solutions.
  - 4 references
- [B12] Forti, M. and Millanta, L. "Power-Line Impedance and the Origin of the Low-Frequency Oscillatory Transients." *IEEE Transactions*, EMC-32, No.2, May 1990, pp. 87–97.
- Theoretical considerations and actual measurements on the occurrence of neutral-ground surges.
  - 18 references

- [B13] Gaibrois, G. L., Mashikian, M. S., and Johnson, K. "Study of Lightning Current Magnitude Through Distribution Arresters." EPRI Report No. EL-1140, Sept. 1979.
- Citation of long duration current in arresters.
  - 8 references
- [B14] Goedbloed, J. J. "Transients in Low-Voltage Supply Networks." *IEEE Transactions*, EMC-29, No. 2, May 1987, pp. 104–115.
- Shows rates of rise up to 30 kV/ $\mu$ s, peaks exceeding 3 kV.
  - Contains extensive analysis of data.
  - 13 references
  - See section A3 for a more detailed review of this paper.
- [B15] Goldstein, M. and Speranza, P. D. "The Quality of U.S. Commercial AC Power." *Intelec Conference Proceedings*, 1982, pp. 28–33.
- Monitoring with Dranetz 606-3.
  - Statistical discussion.
  - See section A3 for a more detailed review of this paper.
- [B16] Haruki, H., Sunaga, M., Kimata, R., and Katoh, J. "Development of a Lightning Current Waveform Measuring System for 500 kV Overhead Transmission Lines." *IEEE Transactions*, PWRD-4, No. 3, July 1989, pp. 1891–1896.
- Reports submicrosecond rise times of lightning current and differences in winter and summer lightning in Japan.
  - 7 references
- [B17] Hasler, R., and Lagadec, R. "Digital Measurement of Fast Transients on Power Supply Lines." *Proceedings, Third Symposium on EMC*, Rotterdam, May 1979, pp. 445–448.
- Results of monitoring with a custom digital system show ring waves and nanosecond rise times near switching devices.
  - 1 reference (in German)
- [B18] Lenz, J. E. "Basic Impulse Insulation Levels of Mercury Lamp Ballasts for Outdoor Applications." *Illuminating Engineering*, Feb. 1964, pp. 133–140.
- Reports (in the discussion) oscilloscope recordings at pole-mounted distribution transformers with 5.6 kV peaks—the maximum surge level in 120 V rms circuits found in the literature.
- [B19] Johnson, I. B., Silva, R. F., and Wilson, D. D. "Switching Surges Due to Energization or Reclosing." *Proceedings, American Power Conference*, vol. XXIII, 1961, pp. 729–736.
- Transient Network Analyzer study.
  - 4 references
- [B20] Kimbark, E. W. and Legate, A. C. "Fault Surge Versus Switching Surge—A Study of Transient Overvoltages Caused by Line-to-Ground Faults." *IEEE Transactions*, PAS-87, No. 9, Sept. 1968, pp. 1762–1769.
- Theoretical treatment of the subject.
  - 5 references

- [B21] MacGorman, D. R., Maier, M. W., Rust, W. D. NUREG Report CR-3759, "Lightning Strike Density for the Contiguous United States From Thunderstorm Duration Records." U.S. Nuclear Regulatory Commission, 1984.
- Lightning strike density computed from aviation station observations, presented as maps and tables.
  - 16 references
- [B22] Martzloff, F. D. and Hahn, G. J. "Surge Voltages in Residential and Industrial Power Circuits." *IEEE Transactions*, PAS-89, No. 6, July/Aug. 1970, pp. 1049–1056.
- Oscilloscope recordings show ring waves; peak detector recordings yield statistics.
  - Documents the anecdotal story of clock motors.
  - 9 references
  - See section A3 for a more detailed review of this paper.
- [B23] Martzloff, F. D., "Varistor Versus Environment: Winning the Rematch." *IEEE Transactions*, PWRD-1, No. 2, April 1986, pp. 59–65.
- Propagation of low-frequency, capacitor switching ring waves from substation to low-voltage load.
  - Coordination between 3 kV and 480 V varistor surge diverters.
  - 15 references, 1 discussion
- [B24] McEachern, A. *Handbook of Power Signatures*. Foster City, CA: Basic Measuring Instruments Publishers, 1989.
- Reports generic types of disturbances.
  - Procedures on conducting a site survey.
  - See A6.6 for a more detailed review of this book.
- [B25] Meissen, W. "Überspannungen in Niederspannungsnetzen." ("Overvoltages in Low-Voltage Networks.") *Elektrotechnische Zeitschrift*, vol. 104, 1983.
- Surges measured in branch circuits (fault clearing by fuses) in millisecond range.
  - 5 references (in German)
- [B26] Mellitt, B. "Transient Voltages Generated by Inductive Switching in Control Circuits." *Proceedings IEE*, vol. 121, No. 7, July 1974, pp. 668–676.
- Shows field and laboratory recordings of bursts such as those involved in the IEC EFT specifications.
  - 11 references
- [B27] Minegishi, S., Echigo, H., and Sato, R. "Frequency Spectra of the Arc Current Due to Opening Electric Contacts in Air." *IEEE Transactions*, EMC-31, No. 4, Nov. 1989, pp. 342–345.
- Reports measurement in megahertz range of contact opening sequences.
  - 11 references
- [B28] Niggli, M. R., Yturralde, W. E., Niebuhr, W. D., Rocamora, R. G., and Madzarevic, V. "Fault Clearing Overvoltages on Long Transformer Terminated Lines." *IEEE Transactions*, PAS-98, No. 2, March/April 1979, pp. 567–578.
- Transient Network Analyzer study.
  - 9 references, 4 discussions



- [B29] Odenberg, R. and Braskich, B. J. "Measurements of Voltages and Current Surges on the AC Power Line in Computer and Industrial Environments." *IEEE Transactions*, PAS-104, No. 10, Oct. 1985, pp. 2681–2691.
- Reports long-duration surges (1000  $\mu$ s).
  - 5 references, 2 discussions
  - See sections A3 and A6 for a more detailed review of this paper.
- [B30] Orville, R. E., Henderson, R. W., and Pyle, R. B. "Lightning Flash Characteristics: 1987." Interim Report EL-6413, August 1989, Electric Power Research Institute.
- Statistics and maps of lightning ground flashes for Eastern United States.
  - 13 references
- [B31] Rhoades, W. T. "Characteristics of Unusual Power Mains Transients." *Proceedings, 1985 Zurich EMC Symposium*, pp. 401–406.
- Transients associated with UPS operation and CRT flashover.
  - 5 references
- [B32] Speranza, P. D. "A Look at the Quality of AC Power Serving the Bell System." *Bell Lab Record*, July/Aug. 1982, pp. 148–152.
- Generic report of recordings and statistical discussion.
- [B33] Trueblood, H. M. and Sunde, E. D. "Lightning Observations in Buried Cables." *Bell System Technical Journal*, XVIII, April 1949, p. 297.
- Presents the concept of "stroke factor."
- [B34] Wernström, H., Broms, M., and Boberg, S. "Transient Overvoltages on AC Power Supply Systems in Swedish Industry." Report FOA E 30002-E2, Foorsvarets Forskningsanstaltd, Huvudavdelning 3, Sweden, 1984.
- Shows rise times in the range of 60 ns to 600 ns.
  - Contains a graph of number of occurrences versus peaks.
  - 12 references
  - See sections A3 and A6 for a more detailed review of this paper.
- [B35] Wiitanen, D. O., Morgan, J. D., and Gaibrois, G. L. "Station Capacitor Switching Transients—Analytical and Experimental Results." *IEEE Transactions*, PAS-90, No. 4, April 1971, pp. 1639–1645.
- Switching transients at the 41 kV level.
  - 10 references, 2 discussions
- [B36] Vines, R. M., Trussell, H. G., Gale, L. J. and O'Neal, B. "Noise on Residential Power Distribution Circuits." *IEEE Transactions*, EMC, Nov. 1984.
- Reports conducted noise measurements from typical residential loads.
  - 14 references
- [B37] Sandler, R. B. "Transients on the Mains in a Residential Area." *IEEE Transactions*, EMC-31, May 1989, pp. 170–176.
- Reports measurements with digital oscilloscope.
  - 6 references

**C3. Propagation, Attenuation, and Mitigation**

- [B38] Chowdhuri, P. "Transient Voltage Characteristics of Silicon Power Rectifiers." *IEEE Transactions*, IA-9, No. 5, Sept./Oct. 1973, p. 582.
- Test results showing effect of timing of surges on failure level.
- [B39] IEEE Switchgear Committee and Surge Protective Devices Committee Working Group. "Coordination of Lightning Arresters and Current-Limiting Fuses." *IEEE Transactions*, PAS-91, No. 3, May/June 1972, pp. 1075–1078.
- Discusses the implications of surge produced by fuse operation.
- [B40] Kershaw, S. S., Huber, W. J., and Hassler, S. P. "Effect of Current Limiting Fuse Operation on Arrester Performance." *Proceedings, IEEE Underground Conference*, 1976, Atlantic City, NJ.
- Discusses implications of surges produced by fuse operation.
- [B41] Martzloff, F. D. and Crouch, K. E. "Coordination de la protection contre les surtensions dans les réseaux basse tension résidentiels." *Proceedings, 1978 IEEE Canadian Conference on Communications and Power*, 78CH1373-0, pp. 451–454.
- Reports laboratory injection of lightning current in house wiring.
  - Illustrates conversion of unidirectional into oscillatory surges.
  - 4 references
  - Data cited in section A1.
- [B42] Martzloff, F. D. "Coordination of Surge Protectors in Low-Voltage AC Power Circuits." *IEEE Transactions*, PAS-99, No. 1, Jan/Feb. 1980, pp. 129–133.
- Coordination between gap-type and clamp-type protectors.
  - Coupling between grounding conductor and phase wires.
  - 7 references
- [B43] Martzloff, F. D. "The Propagation and Attenuation of Surge Voltages and Surge Currents in Low-Voltage AC Power Circuits." *IEEE Transactions*, PAS-102, No. 5, May 1983, pp. 1163–1170.
- Propagation and attenuation of 1.2/50  $\mu$ s and 100 kHz Ring Wave.
  - Coupling of differential mode through isolation transformers.
  - Mode conversion by various connections of surge diverters.
  - 9 references, 1 discussion
- [B44] Martzloff, F. D. and Gauper, H. A. "Surge and High-Frequency Propagation in Industrial Power Lines." *IEEE Transactions*, IA-22, No. 4, July/Aug. 1986, pp. 634–640.
- Propagation of 100 kHz ring wave in steel conduit lines.
  - Options for coupling one, two, or three surge diverters at line end; resulting mode conversion.
  - 8 references
- [B45] Martzloff, F. D. and Wilson, P. F. "Fast Transient Tests: Trivial or Terminal Pursuit?" *Proceedings, Zurich 1987 EMC Symposium*, pp. 283–288.
- Measurement and modeling of the attenuation of pulses with nanosecond rise time pulses in steel conduit lines.
  - 8 references

- [B46] Martzloff, F. D. and Leedy, T. F. "Selecting Varistor Clamping Voltage: Lower is Not Better!" *Proceedings, Zurich 1989 EMC Symposium*, pp. 137–142.
- Adverse effects of unnecessarily low clamping voltages.
  - Experimental and theoretical considerations.
  - 11 references
- [B47] Martzloff, F. D. and Leedy, T. F. "Electrical Fast Transients: Application and Limitations." *IEEE Transactions*, IA-26, No. 1, Jan./Feb. 1990, pp. 151–159.
- Measurement and modeling of the attenuation of the IEC EFT 5-50 ns pulse in steel conduit and nonmetallic jacket lines.
  - 9 references
- [B48] Martzloff, F. D. "Coupling, Propagation, and Side Effects of Surges in an Industrial Building Wiring System." *IEEE Transactions*, IA-26, No. 2, March/April 1990, pp. 193–203.
- Propagation and attenuation in multibranch systems.
  - Surges in power lines may cause failures of data port components when ground loops exist between separate pieces of equipment connected by data link.
  - 11 references
- [B49] Standler, R. B. "Protection of Small Computers from Disturbances on the Mains." *Proceedings, IEEE-IAS Annual Meeting*, Oct. 1988, pp. 1482–1487.
- Simple method for protecting electronic system on 120 V rms single-phase mains up to 800 VA from damages or upset from surges, disturbances of rms voltages, and outages.
  - 12 references
- [B50] Paul, C. R. and Hardin, K. B. "Diagnosis and Reduction of Conducted Noise Emissions." *IEEE Transactions*, EMC, Nov. 1988, pp. 553–560.
- Method for determination of relative value of common-mode and normal-mode noise, with modeling of candidate mitigation methods.
  - 5 references
- [B51] Vines, R. M., Trussell, H. G., Gale, L. J., and O'Neal, B. "Impedance of the Residential Power Distribution Circuit." *IEEE Transactions*, EMC, Feb. 1985.
- Measurement and analysis of mains impedance in the 5–20 kHz range.
  - 7 references

#### C4. Reviews and Discussions

- [B52] Bodle, D. W., Ghazi, A. J., Syed, M., and Woodside, R. L. *Characterization of the Electrical Environment*. Toronto and Buffalo, NY: University of Toronto Press, 1976.
- Book initially written from the communications point of view but applicable to ac power circuits.
  - 124 references, 320 pages
- [B53] Fisher, F. A. and Martzloff, F. D. "Transient Control Levels: A Proposal for Insulation Coordination in Low-Voltage Systems." *IEEE Transactions*, PAS-95, No. 1, Jan./Feb. 1976, pp. 120–129.
- Parallel with the BIL concept for a high-voltage system.
  - First version of a test circuit for a 100 kHz Ring Wave.
  - 12 references, 3 discussions

- [B54] Golde, R. H., ed. *Lightning*, vols. 1 and 2, New York: Academic Press, 1977.
- Vol 1: Physics of lightning.
  - Vol 2: Lightning protection.
  - Several hundred references
- [B55] Greenwood, A. *Electrical Transients in Power Systems*. New York: Wiley-Interscience, 1971.
- Comprehensive textbook.
  - Cites 2.1 per-unit overvoltage during ground fault clearing.
  - 210 references, 540 pages
- [B56] Gruzs, T. M. "Power Disturbances and Computer Systems: A Comparison of the Allen-Segall and the Goldstein-Speranza Power Line Monitoring Studies." *Proceedings, 1986 Electrical Overstress Exposition*, Nelson Publishing Company, 1986.
- The effect of arbitrary threshold selection on statistics.
  - 2 references
- [B57] IEEE Committee Report. "Bibliography on Surge Voltages in AC Power Circuits Rated 600 Volts or Less." *IEEE Transactions*, PAS-89, No. 6, July/Aug. 1970, pp. 1056–1061.
- Bibliography compiled by the original IEEE working group 3.6.4.
  - 73 references
- [B58] Key, T. S. "Diagnosing Power Quality-Related Computer Problems." *IEEE Transactions*, IA-15, No. 4, July/Aug. 1979, pp. 381–393.
- Records of disturbances and general discussion.
  - Early version of the computer susceptibility curve.
  - 10 references
- [B59] Key, T. S. and Martzloff, F. D. "A Consensus on Powering and Grounding Sensitive Electronic Equipment." *Conference Record, IEEE-IAS Annual Meeting*, Oct. 1986.
- General tutorial discussion of the subject.
  - Proposed computer susceptibility curve.
  - 19 references
- [B60] Martzloff, F. D. "Power Quality Measurements: Bringing Order Out of Chaos." *Proceedings, 1988 Energy Technology Conference*, Feb. 1988, pp. 947–959.
- Condensation of Martzloff/Gruzs paper for power-quality context.
  - 16 references
- [B61] Martzloff, F. D. and Gruzs, T. S. "Power Quality Site Surveys: Facts, Fiction, and Fallacies." *IEEE Transactions*, IA-24, No. 6, Nov./Dec. 1988, pp. 100–1018.
- Review of instrumentation development, definition deficiencies, and past surveys.
  - 33 references
- [B62] Podgorski, A. S. "A Case for a Unified Lightning Threat." *Proceedings, International Aerospace and Ground Conference on Lightning and Static Electricity*, Oklahoma City, 1988, pp. 118–122.
- Measurements of lightning currents on tall towers and aircraft.
  - Reports current rise times in the 50–100 ns range.
  - 14 references

- [B63] Rhoades, W. T. "Designing Commercial Equipment for Conducted Susceptibility." *Proceedings, IEEE EMC Symposium*, 1979.
- Unprotected product input impedances, transient propagation modes and models, measured transient occurrences, and typical susceptibility.
  - 9 references
- [B64] Rhoades, W. T. "Development of Power Main Transient Protection for Commercial Equipment." *Proceedings, IEEE EMC Symposium*, 1980.
- Class distinction of the various wide-range transients from arc to motor turn-on.
  - Low product immunity to common-mode transients is shown to be caused by high energy-density spectrum.
  - 18 references
- [B65] Rhoades, W. T. "The Ratiocination of a Commercial Power Main Conducted Susceptibility Standard." *Proceedings, IEEE EMC Symposium*, 1981, pp. 269–276.
- Review of transient types, standards, definitions, and cost considerations.
  - 18 references
- [B66] Rhoades, W. T. "Critical Analysis of Commercial Power Main Transient Designs." *Proceedings, IEEE EMC Symposium*, 1987, pp. 407–419.
- Review of environment, statistics, measurements, and standards.
  - 38 references
- [B67] Rhoades, W. T. "Congruence of Low Voltage Main Transient Designs." *Proceedings, IEEE EMC Symposium*, 1989, pp. 285–291.
- Survey of the literature on surge occurrence, equipment design, and surge standards.
  - 4 references
- [B68] Sandler, R. B. *Protection of Electronic Circuits from Overvoltages*. New York: Wiley-Interscience, 1989.
- Comprehensive review of the origin and propagation of surges, surge-protective devices and applications in circuits, and high-voltage laboratory testing techniques.
  - 260 references, 434 pages

#### C5. Measurement Techniques and Test Methods

- [B69] Allen, G. W. "Design of Power-Line Monitoring Equipment." *IEEE Transactions*, PAS-90, May 1971, pp. 2604–2609.
- Description of the instrumentation used by Allen and Segall.
  - 5 references
- [B70] Bull, J. H. "Impedance of the Supply Mains at Radio Frequencies." *Proceedings, 2nd Symposium on EMC*, Montreux, May 1975, 75CH1012-4 Mont., pp. 357–362.
- Reports measurements and 50  $\Omega$ /50  $\mu$ H equivalent circuit.
  - 6 references
- [B71] Buschke, H. A. "A Practical Approach to Testing Electronic Equipment for Susceptibility to AC Line Transients." *IEEE Transactions on Reliability*, vol. 37, No. 4, Oct. 1988, pp. 355–359.

- Describes test methods and test circuits developed independently from standard approaches.
  - 3 references
- [B72] Martzloff, F. D. and Fisher, F. A. "Transient Control Level Philosophy and Implementation: The Reasoning Behind the Philosophy." *Proceedings, 2nd Symposium on EMC, Montreux, June 1977, 77CH1224-5EMC.*
- Techniques and equipment for making TCL tests.
  - 10 references
- [B73] Martzloff, F. D. and Fenimore, C. "Validating Surge Test Standards by Field Experience: High-Energy Tests and Varistor Performance." *Conference Record, IEEE/IAS Annual Meeting, Oct. 1990.*
- Computer modeling of the current and energy deposition into typical varistors subjected to the 10/1000  $\mu$ s waveform.
  - Predictions of failure for the small varistors and survival for the larger varistors agree with anecdotal field experience.
- [B74] Millanta, L. M., Forti, M. M., and Maci, S. S. "A Broad-Band Network for Power-Line Disturbance Voltage Measurements." *IEEE Transactions*, vol. EMC-30, No.3, Aug. 1988.
- Filter network removing the power-frequency voltage from the record.
  - 15 references
- [B75] Millanta, L. M. and Forti, M. M. "A Classification of the Power-Line Voltage Disturbances for an Exhaustive Description and Measurement." *Proceedings, IEEE EMC Symposium, 1989*, pp. 332-336.
- Proposal for systematic classification of disturbances.
  - 17 references
- [B76] Millanta, L. M. and Forti, M. M. "A Notch-Filter Network for Wide-Band Measurements of Transient Voltages on the Power Line." *IEEE Transactions on EMC*, Aug. 1988.
- Describes the design and characteristics of a probe that filters out the power-frequency component.
  - 20 references
- [B77] Nave, M. J. "A Novel Differential Mode Rejection Network for Conducted Emissions Diagnostics." *Proceedings, IEEE EMC Symposium, 1989*, pp. 223-227.
- Discussion of common mode and differential mode from the point of view of frequency domain measurements.
  - 5 references
- [B78] Richman, P. "Changes to Classic Surge-Test Waves Required by Back-Filters Used for Testing Powered Equipment." *Proceedings, Zurich 1985 EMC Symposium*, pp. 413-419.
- Powered equipment testing considerations.
  - Undershoot effects on unidirectional waves, the case for oscillatory waves.
  - 5 references
- [B79] Richman, P. "Precision Coil Impulse Testing with 0.3 A, Micro-Breakdown Sensitivity." *Power Conversion International*, vol. 8, No. 5, May 1982, pp. 14-82.
- General review of surge generator technology.



- Detection of breakdown by monitoring both voltage and current waveforms in EUT.
  - 11 references
- [B80] Richman, P. "Single-Output, Voltage and Current Generation for Testing Electronic Systems." *Proceedings, IEEE EMC Symposium*, 1983, pp. 14–28.
- Presents the case for the Combination Wave rather than separate 1.2/50 and 8/20  $\mu$ s impulses.
  - 4 references
- [B81] Richman, P. "Criteria and Designs for Surge Couplers and Back-Filters." *Proceedings, IEEE EMC Symposium*, 1989, pp. 202–207.
- Discussion of the need for specific description of the coupling modes associated with surge testing of powered equipment, and rules for test procedures.
  - 3 references
- [B82] Senko, G. "Probes and Techniques for Measuring Surge Voltage Waves with Fronts from 10 ns to 1.2  $\mu$ s and Peaks to 10 kV." *Proceedings, Zurich 1987 EMC Symposium*, pp. 149–154.
- Describes a differential probe with 10 k $\Omega$  input impedance, 2 ns rise time, 10 kV rating.
  - 5 references
- [B83] Standler, R. B. "Calculation of Energy in Transient Overvoltages." *Proceedings, IEEE EMC Symposium*, 1989, pp. 217–222.
- Critical review of using the integral of  $V^2/50\Omega dt$  to compute energy in a surge; concludes that method is invalid.
  - 18 references
- [B84] Standler, R. B. "Equations for Some Transient Overvoltage Tests." *IEEE Transactions, EMC-30*, No. 1, Feb. 1988, pp. 69–71.
- Provides equations for 100 kHz Ring Wave and for unidirectional waves.
  - 7 references
- [B85] Standler, R. B. "An Experiment to Monitor Disturbances on the Mains." *Proceedings, IEEE IAS Annual Meeting*, Oct. 1987, pp. 1325–1330.
- Describes experiment to collect waveforms of mains disturbances and determine the energy deposited in varistors.
  - 16 references
- [B86] Standler, R. B. "Standard Waveforms for Surge Testing: Experimental Evaluation and Proposed New Criteria for Tolerances." *Proceedings, Eighth International Zurich Symposium on Electromagnetic Compatibility*, 1989, pp. 115–124.
- Evaluates several commercial surge generators and proposes using equations to define nominal waveforms and tolerances of unipolar waves.
  - 11 references
- [B87] Wiesinger, J. "Hybrid-Generator für die Isolationskoordination." ("Hybrid Generators for the Coordination of Insulation.") *Elektrotech, Z.*, vol. 104, No. 21, 1983, pp. 1102–1105.
- Endorses the concept of the Combination Wave in the European context.

**C6. Related Standards**

- [B88] IEEE Std 4-1978, Standard Techniques for High Voltage Testing.  
— Basic reference; contains definitions of impulse waveforms.  
— 46 references
- [B89] ANSI C2-1990, National Electric Safety Code.  
— Rules for the installation, operation, and maintenance of power and communication lines and equipment operated by utilities.
- [B90] UL 93-1975, The Standard for Safety—Ground Fault Circuit Interrupters.
- [B91] UL 1449-1988, The Standard for Safety—Transient Voltage Surge Suppressors.  
— Specifies safety aspects of suppressor design.  
— Specifies the citation of clamping voltage levels.
- [B92] IEC 60-2 (1973), High voltage test techniques—Part 2: Test procedures.  
— Defines parameters of impulse waveforms.
- [B93] IEC 99, Lightning Arresters.  
— Performance standards for surge arresters.
- [B94] German Standard VDE 0160, Ausrüstung von Starkstromanlagen mit elektronischen Betriebsmitteln (Equipment with electronic operating controls for use on power systems), May 1988, amended April 1989.  
— Specifies surge test with 100/1300  $\mu$ s high-energy waveform.  
— May be incorporated in IEC standards under development by TC77.  
— English translation available from the British Standards Institution, Linford Woods, Milton Keynes, MK14 6LE, UK.
- [B95] IEC 50-161 (1990), IEC International Electrotechnical Vocabulary, Chapter 161: Electromagnetic compatibility.