ASSIST *recommends...*

Recommended metric for assessing the direct perception of light source flicker

Volume 11, Issue 3
January 2015



www.lisungroup.com

A publication of the Alliance for Solid-State Illumination Systems and Technologies

Lighting
Research Center



Copyright © 2015 by the Alliance for Solid-State Illumination Systems and Technologies (ASSIST).

Published by the Lighting Research Center, Rensselaer Polytechnic Institute, 21 Union St., Troy, NY 12180, USA.
Online at <http://www.lrc.rpi.edu>.

All rights reserved. No part of this publication may be reproduced in any form, print, electronic, or otherwise, without the express permission of the Lighting Research Center.

This publication can be cited in the following manner:

Alliance for Solid-State Illumination Systems and Technologies (ASSIST). 2015. *ASSIST recommends... Recommended metric for assessing the direct perception of light source flicker*. Vol. 11, Iss. 3. Troy, N.Y.: Lighting Research Center. Internet: <http://www.lrc.rpi.edu/programs/solidstate/assist/recommends/flicker.asp>.

ASSIST recommends is prepared by the Lighting Research Center (LRC) at the request of the Alliance for Solid-State Illumination Systems and Technologies (ASSIST). The recommendations set forth here are developed by consensus of ASSIST members and the LRC, but are not necessarily endorsed by individual companies. ASSIST and the LRC may update these recommendations as new research, technologies, and methods become available.

Check for new and updated *ASSIST recommends*: <http://www.lrc.rpi.edu/programs/solidstate/assist/recommends.asp>



ASSIST Members

3M	Intematix Corp.
Acuity Brands Lighting	Legrand
Amerlux	New York State Energy Research and Development Authority
BAE Systems	OSRAM SYLVANIA / OSRAM Opto Semiconductors
Bridgelux	Philips Lighting
Cree	Philips Lumileds
Crouse-Hinds by Eaton	Samsung Electronics Co.
Dow Corning	Seoul Semiconductor
Federal Aviation Administration	United States Environmental Protection Agency
GE Lighting Solutions	
Hubbell Lighting	

LRC Technical Staff

A. Bierman

Contents

Abstract	4
Introduction	5
The Flicker Perception Metric	5
Step 1: Acquire light output waveform	6
Sampling rate	6
Record length	7
Step 2: Apply Fourier Transform.....	7
Step 3: Calculate Weber Temporal Contrast.....	7
Step 4: Apply Perceptual Sensitivity Weighting.....	8
Step 5: Combine Frequency Components	8
Equipment and Techniques for Acquiring High Fidelity Light Waveforms.....	8
Photodetector Selection.....	8
Frequency response.....	8
Spectral response.....	8
Amplification and Analog Filtering	8
Waveform Digitization	9
Oscilloscopes	9
Circuit Design Example	9
Interpreting Metric Values	10
Example Calculations.....	11
Example 1: Low frequency PWM with dc.....	11
Example 2: Half-wave rectified sinewave	12
Example 3: Phase-cut dimming instability	13
References.....	14
Acknowledgments.....	14
About ASSIST	14
Appendix A – Light Flicker Detection Threshold Spectrum	15
Appendix B – Example of Implementation of the Flicker Perception Metric Calculation as a Matlab [®] Function.....	16
Appendix C – Example of a Matlab [®] Script to Calculate and Display the Components of the Flicker Perception Metric	17

Abstract

This issue of *ASSIST recommends* describes an objective method to assess the perception of flicker directly observed from light sources. Calculation of the metric starts with a relative light output waveform measurement and finishes with a single numerical result indicating whether the amount of flicker is above or below the human threshold of perception. Alternately, the result can be expressed as the probability of an observer detecting flicker from the source. The metric is applicable to any waveform shape and frequency.

www.Lisungroup.cc

Introduction

With the proliferation of solid-state light sources, there is a renewed interest in flicker issues that is not satisfied with the existing methods of quantifying the human response to flicker. The two most commonly used metrics for flicker, percent flicker (Rea 2000) and flicker index (Eastman and Campbell 1952), describe aspects of the physical waveform but do not relate it to human perception. Importantly, both these metrics fail to include the frequency of the flicker, which is critical for determining its perception.

The graph on the left of figure 1 shows the average modulation threshold needed to detect flicker as a function of frequency for a group of 10 subjects viewing an A-lamp-sized light source (Bodington et al., in press). Modulation threshold is measured as percent flicker. The graph on the right shows the same data plotted as sensitivity to flicker (sensitivity $\propto 1/\text{detection threshold}$). Note that at the frequency of greatest sensitivity, occurring at about 15 Hz, people can detect 0.5% flicker, while at 60 Hz nearly 60% modulation is needed for detection.

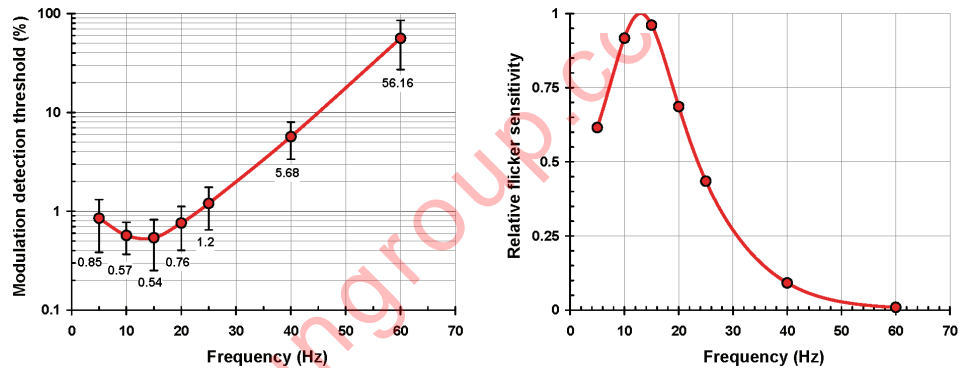

Figure 1. Average modulation threshold in percent (left) to detect flicker as a function of frequency and data plotted as relative sensitivity (right). See Bodington et al. (in press) for more details.

The purpose of the metric described here is to accurately predict human flicker perception for any lamp, light output waveform, and frequency. Specifically, this metric deals with the direct perception of flicker in which the frequency of modulation is low enough to be able to be seen directly (i.e., frequency < 80 Hz), and not with indirect perception manifested through the interaction of the light source with moving objects (i.e., stroboscopic effects). For indirect flicker concerns, see *ASSIST recommends...Flicker Parameters for Reducing Stroboscopic Effects from Solid-state Lighting Systems Volume 11, Issue 1* (ASSIST 2012) and *ASSIST recommends...Application Considerations Related to Stroboscopic Effects from Light Source Flicker Volume 11, Issue 2* (ASSIST 2014).

The Flicker Perception Metric

Figure 2 summarizes the main steps to acquire the light waveform and compute the proposed flicker metric. Considerations and further details for each step are provided in the following sections of this document. Appendix A supplies a particular set of flicker sensitivity data for computing the metric. Appendices B and C provide Matlab[®] code examples for calculating and implementing the metric. Appendices B and C, along with the example waveform data used in this

document are available for download from the ASSIST recommends webpage: <http://www.lrc.rpi.edu/programs/solidstate/assist/recommends/flicker.asp>.

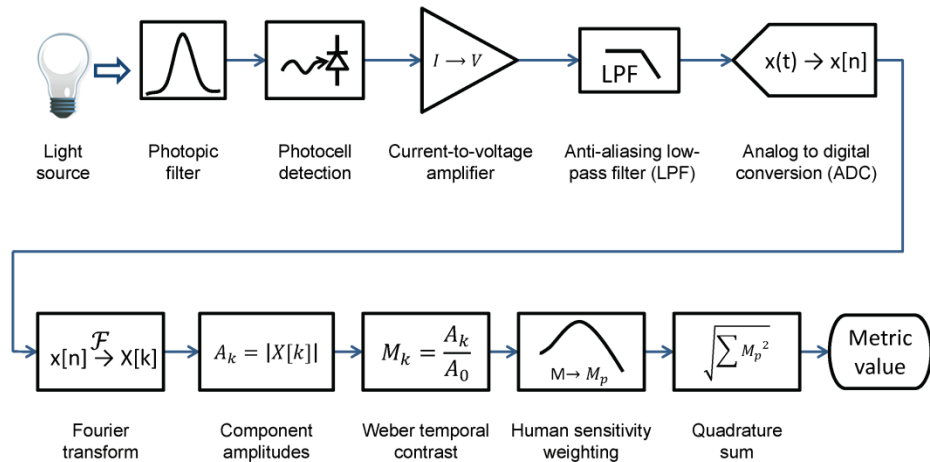

Figure 2. Order of steps to measure the light waveform and compute the proposed flicker metric.

Step 1: Acquire light output waveform

The sole input to the metric is a relative light output waveform. The waveform must accurately represent the variation in light output with time. An oscilloscope is typically the instrument used for capturing waveforms, in this case the waveform from a photodetector; however, common oscilloscopes are typically limited to 8-bits of signal amplitude resolution (also known as vertical resolution), which is insufficient precision for measuring flicker thresholds that are as small as 0.5%. Therefore, special methods and/or specialized equipment must be used to capture the light output waveform. (See next section for guidelines on instrumentation for acquiring high fidelity light output waveforms.) The photocell must not be exposed to any light other than that from the light source under test. One way to achieve this is to place the light source and photocell inside an opaque box. Alternately, waveforms may be recorded in an otherwise dark room. For increased accuracy any dc bias or offset introduced by the analog circuitry should be eliminated by subtracting readings of the sensor when dark.

Sampling rate

ASSIST recommends a minimum sampling rate of 2000 samples/s.

Digital acquisition theory states that the highest frequency component represented in a sampled waveform is half the sampling frequency. For the flicker perception metric, the highest frequency of interest is approximately 100 Hz, which is just above the perception limit for observing direct flicker. Therefore, a minimum 200 Hz sampling rate would be required for a theoretically ideal measurement system. Actual measurement systems are far from ideal, so at a minimum a factor of 10 oversampling is recommended for waveform capture. This extra sampling bandwidth eases requirements on analog anti-aliasing low-pass filtering, which is required for accurate digital representation of waveforms. Higher sampling rates can ease analog filtering requirements even more, but at the expense of larger data files and computation times.

Record length

ASSIST recommends a minimum sampling record length of 2 s.

The length of the captured waveform determines the lowest, non-zero frequency component that can be analyzed as well as the spacing of the temporal frequency components. For a minimum frequency of 5 Hz, a record length of 200 ms is required, but the frequency intervals would also be 5 Hz (e.g., 5 Hz, 10 Hz, 15 Hz...) which is too coarse considering the relatively rapid changes in flicker sensitivity with frequency. A record length of 2 s provides a frequency interval of 0.5 Hz.

A longer record length also provides a better time-averaged representation of the light output. This is especially important if the light source is not stable. Record lengths up to about 10 s will likely provide more consistent results for instable light sources; however, long record lengths demand significant computing resources and produce very narrow frequency intervals. Collecting statistics on several shorter record lengths is preferable to record lengths over 10 s.

Step 2: Apply Fourier Transform

The discrete Fourier transform, X , is defined as:

$$X_k = \sum_{n=0}^{N-1} x_n e^{-\frac{i2\pi kn}{N}}$$

(Eq. 1)

where x_n are the sampled data values, N is the number of samples, and k is an integer denoting the frequency of each component. Frequency in cycles per second (Hz) is given by $f=kS/N$ with S being the sampling rate (also in units of Hz). X_k are complex numbers with amplitudes given by:

$$A_k = \frac{\sqrt{Re(X_k)^2 + Im(X_k)^2}}{N}$$

(Eq. 2)

where $Re(X_k)$ and $Im(X_k)$ are used to designate the real and imaginary components, respectively, of the complex numbers of the transform result.

Step 3: Calculate Weber Temporal Contrast

Divide each of the component amplitudes, A_k , by the dc value of the waveform, A_0 . This operation normalizes the component amplitude values expressing them as modulation ratios, hence the symbol M .

$$M_k = \frac{A_k}{A_0}$$

(Eq. 3)

For single frequency waveforms (i.e., a sinewave) the single modulation value is equivalent to percent flicker when multiplied by 100%.

Step 4: Apply Perceptual Sensitivity Weighting

Divide each component modulation ratio, M_k , by the human modulation detection threshold for that frequency, M_{DTHk} .

$$M_{Pk} = \frac{M_k}{M_{DTHk}} \quad (\text{Eq. 4})$$

The resulting component modulation values are now expressed in terms of human detection thresholds and denoted as M_{Pk} for perceptual modulation. A perceptual modulation value of 1 corresponds to threshold detection (50% detection rate). Values much less than 1 are undetectable, while values much greater than 1 are easily seen.

Step 5: Combine Frequency Components

The individual perceptual modulation values are combined by summing all squared component values (excluding the dc component) and then taking the square-root of the sum.

$$M_P = \sqrt{\sum_k (M_{Pk})^2} \quad (\text{Eq. 5})$$

$k = 1, 2, 3, \dots$

The resulting perceptual modulation value, M_P , is interpreted the same as the individual perceptual modulation values: a value of 1 corresponds to threshold detection, values much less than 1 are undetectable, while values much greater than 1 are easily seen. (See Interpreting Metric Values on pg. 10 for details.)

Equipment and Techniques for Acquiring High Fidelity Light Waveforms

Photodetector Selection

Frequency response

The photodetector and amplification circuitry work together to determine the frequency response of the measurement system. The frequency response of the system must be flat from dc to 100 Hz, and then decrease for higher frequencies so that the response is negligible for frequencies above half the digital sampling rate (i.e. the Nyquist sampling criterion). Most photodiodes can achieve this frequency response if operated with a suitable amplifier.

Spectral response

The photodetector should have a spectral responsivity that closely matches the CIE photopic observer ($V(\lambda)$). A figure of merit for matching the photopic observer is the CIE f_1' value. ASSIST recommends $f_1' < 5\%$.

Amplification and Analog Filtering

Photodiode detectors must be operated with a transimpedance amplifier (current to voltage amplifier) in order to ensure a linear response and suitable signal range for input to the waveform digitizer. While commercial transimpedance

amplifiers are readily available, a simple op-amp circuit can suffice. A reference design is provided in the circuit design example below. A selector switch with access to different gain values may be convenient to ensure the setup has sufficient sensitivity to accommodate a range of measurements from low to high light output.

An analog anti-aliasing filter is required to ensure that frequency components above the Nyquist sampling criterion, if they exist, do not degrade the accuracy of the digitized waveform for analysis within the frequency bandwidth of interest. A low-pass filter with a linear phase response, such as a simple RC filter, is recommended to prevent waveform distortion within the pass band. The gradual attenuation of RC filters with frequency, however, requires a large digital oversampling factor of perhaps 100 or more. To reduce such a large amount of digital oversampling a multipole Bessel type filter is another option.

Waveform Digitization

ASSIST recommends a waveform digitizer with at least 12-bits of vertical resolution (4096 levels). For an analog waveform that is scaled to exactly match the input range of the digitizer, 12-bits provides a maximum resolution of 0.05% ($\approx 1/2048$) which is one tenth the minimum modulation detection threshold. This corresponds to a resolution of only 10% relative to the human modulation detection limit. In practice the analog waveform is rarely perfectly matched to the input range due to a limited number of analog gain settings, so the actual resolution will likely be less than this. Nowadays, 16-bit digitizers are common and their use here would ease the number of analog gain settings needed to obtain the required vertical resolution.

Oscilloscopes

Standard oscilloscopes employing 8-bit waveform digitizers do not have sufficient vertical resolution for measuring all types of perceptible flicker. Some high-end oscilloscopes, however, have a digital signal processing feature called Enhanced Vertical Resolution by which 3 bits or more of additional vertical resolution is gained at the expense of effective sampling rate. Basically, the signal is oversampled by a large factor at 8-bit resolution and then low-pass filtered to extend the resolution beyond 8 bits. Since the sampling rates of oscilloscopes extend many orders of magnitude beyond what is required for perceptible flicker measurements, using a scope with an enhanced vertical resolution feature is a possible, yet unexplored option.

Circuit Design Example

The circuit schematic shown in Figure 3 implements the basic analog circuitry needed to acquire light waveforms. The op-amp on the left is configured as a transimpedance amplifier with selectable gains of approximately 9.0×10^4 , 9.1×10^5 and 1.0×10^6 volts/ampere. The photodiode is a PIN type with low capacitance for high speed and a relatively large active area (3.6 x 3.6 mm).

The op-amp on the right is configured as a 2 pole Sallen-Key low-pass active filter with a -3dB point at 1941 Hz. This forms the antialiasing filter prior to waveform digitization. The passband of this filter is flat to within 0.02 dB for signals less than 100 Hz and flat to within 0.003dB for signals less than 30 Hz where flicker sensitivity is greatest. On the high frequency side, the -40 dB point is at 20 kHz, so a sampling rate of 40 kHz is needed to ensure that any out-of-band signal content is reduced to less than 1% of the dc level. This is a very

conservative design dealing with the possibility of light signals having near 100% modulation at frequencies in the kilohertz range. Less extreme sampling rates and/or filtering requirements can be justified if the light signals are known to be limited in their high frequency content. Alternately, a higher order antialiasing filter can be used to reduce sampling rates.

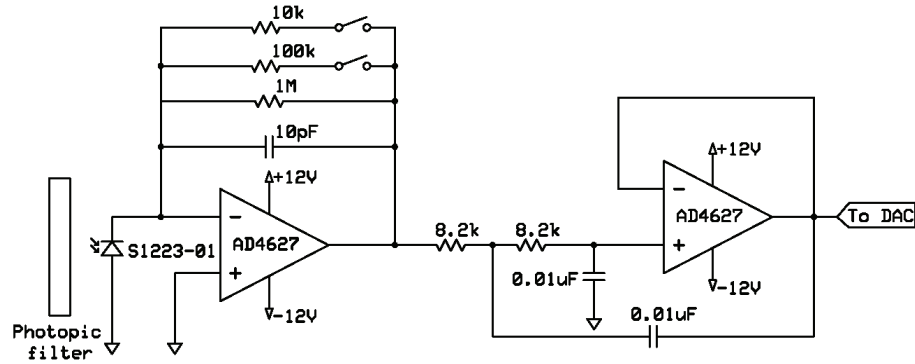

Figure 3. Circuit schematic example implementing the basic analog circuitry needed to acquire light waveforms. The PIN photodiode (S1223-01) and photopic filter can be substituted by an illuminance probe.

Interpreting Metric Values

Data on flicker perception rates for various light waveforms have been collected from a group of 10 subjects at the Lighting Research Center (Bodington et al., in press). Using the corresponding metric values, these flicker perception rates are well fit by the sigmoid-shaped curve given by equation 6 and shown in Figure 4. With this relationship established, metric values can be converted to detection probabilities.

$$\text{Flicker detection probability (\%)} = \frac{100}{1 + e^{-5.40(M_P - 1.04)}} \quad (\text{Eq. 6})$$

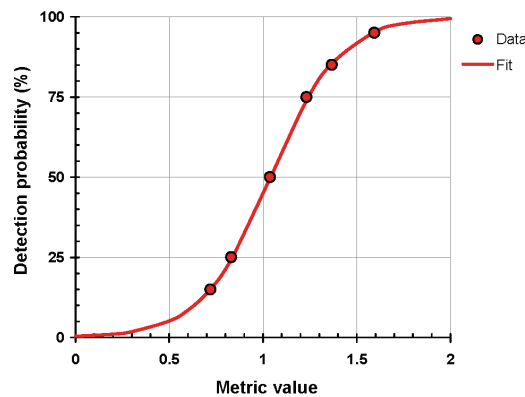

Figure 4. Relationship between flicker detection probability and the metric value.

Example Calculations

Example 1: Low frequency PWM with dc

Figure 5 shows the results of a flicker analysis for a 10 Hz pulse waveform with a large dc offset. The top graph in the figure is a plot of the waveform. The middle graph shows the spectral content after Fourier decomposition and Weber contrast normalization.

The bottom graph shows the spectral components after being weighted by the human sensitivity to flicker (shown in Figure 1). A value of 1 corresponds to the threshold of flicker detection. In this case, two components, the 10 Hz and 20 Hz components, exceed the threshold. The flicker metric for this waveform, 4.1, is well beyond threshold, thereby making the detection probability approach 100%.

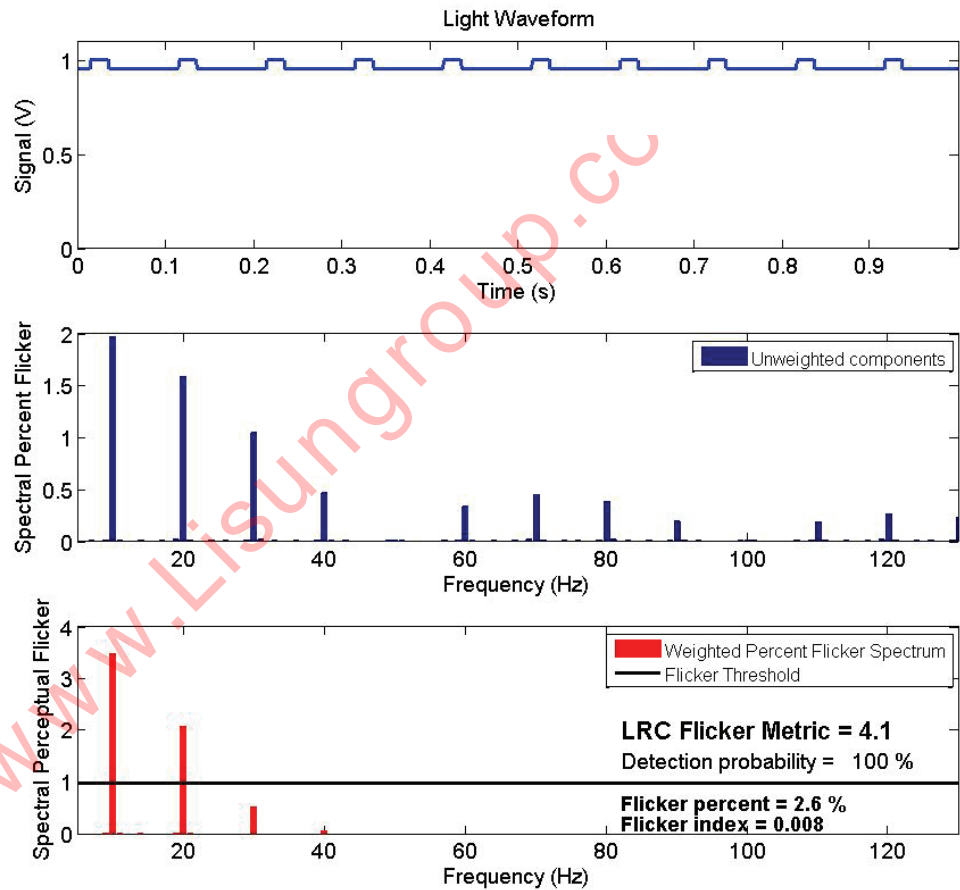

Figure 5. Flicker analysis results for a 10 Hz waveform consisting of a 20% duty cycle rectangular pulse of amplitude 0.05 with a 0.95 offset.

A text file (idealPWMwithDcWaveform.txt) with the waveform data for this example is available for download from the ASSIST recommends webpage: <http://www.lrc.rpi.edu/programs/solidstate/assist/recommends/flicker.asp>.

Example 2: Half-wave rectified sinewave

Figure 6 shows the results of a flicker analysis for a 60 Hz half-wave rectified sinewave. A similar waveform would arise from driving a single LED from an ac source. In this case, there is only one frequency component, the 60 Hz component, within the range of directly perceptible flicker. Notice that the spectral percent flicker values can exceed 100%. This means that certain individual spectral components have amplitudes greater than the maximum amplitude of the composite waveform. The composite waveform has lower amplitude than some of its spectral components due to the phases of the spectral components (phase is not shown on graph) being different; adding components of differing phase can reduce the peak value.

The human sensitivity weighted magnitude of the 60 Hz component exceeds the detection threshold, making this flicker easily detectable. It is noteworthy to compare the traditional flicker metrics (flicker index and percent flicker) of this example with those of the previous example. While both waveforms have similar flicker perception metric values, the traditional metrics indicate large differences in flicker.

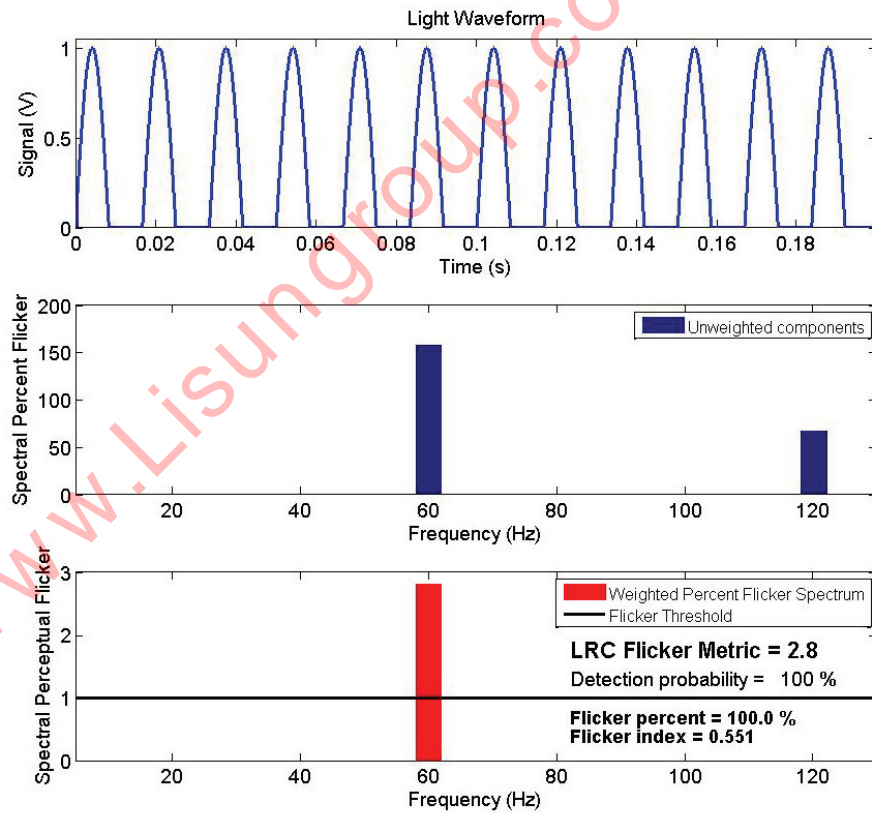

Figure 6. Flicker analysis results for a half-rectified, 60 Hz cosine waveform.

A text file (idealHalfrectifiedSinWaveform.txt) with the waveform data for this example is available for download from the ASSIST recommends webpage: <http://www.lrc.rpi.edu/programs/solidstate/assist/recommends/flicker.asp>.

Example 3: Phase-cut dimming instability

Figure 7 shows the results of a flicker analysis for a measured light waveform of a triac-dimmed LED A-lamp. The great majority of the light output modulation occurs at 120 Hz, which is beyond the human sensitivity range for direct flicker perception, and therefore has no influence on the flicker perception metric described in this document. What does influence the metric is the seemingly small low-frequency instability of the light output.

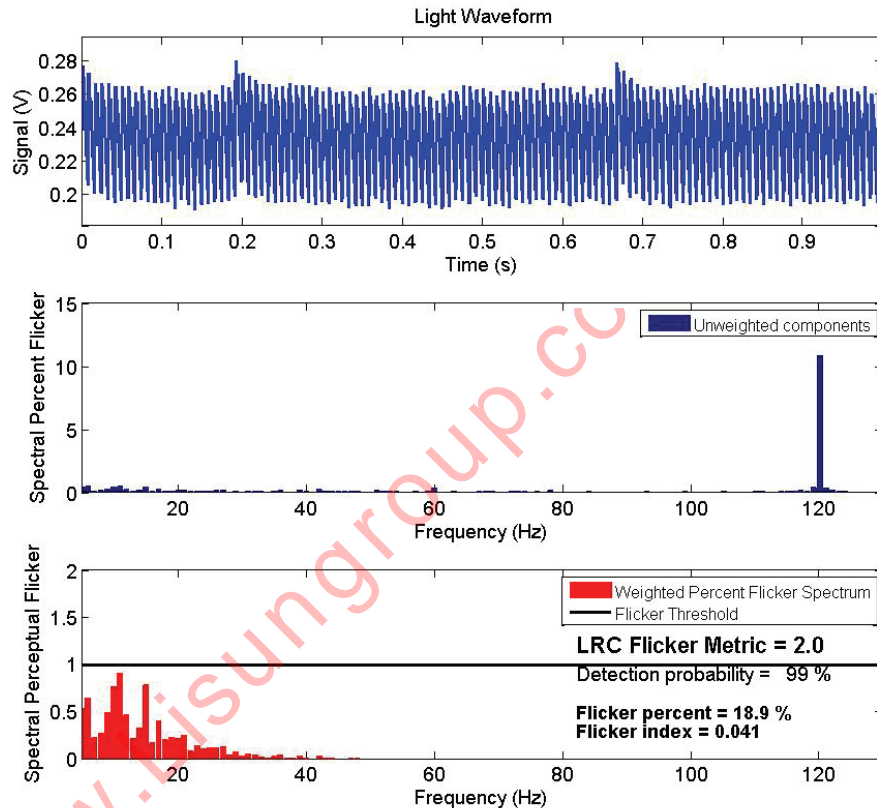

Figure 7. Flicker analysis results for a measured light waveform of a triac-dimmed LED A-lamp.

When the frequency components of the waveform are weighted by human detection sensitivity, the low frequency magnitudes approach the detection threshold. While no single component exceeds the detection threshold, the collected effect of the frequency components exceeds the detection threshold, making this flicker easily perceptible. Both of the traditional metrics are mainly influenced by the 120 Hz component, thereby obscuring the importance of the relatively low-frequency light output instabilities for producing directly perceptible flicker.

A text file (dimmedLEDALampWaveform.txt) with the waveform data for this example is available for download from the ASSIST recommends webpage: <http://www.lrc.rpi.edu/programs/solidstate/assist/recommends/flicker.asp>.

References

- Alliance for Solid-State Illumination Systems and Technologies (ASSIST). 2005. *ASSIST recommends: LED Life for General Lighting*. Internet: <http://www.lrc.rpi.edu/programs/solidstate/assist/recommends/ledlife.asp>.
- Alliance for Solid-State Illumination Systems and Technologies (ASSIST). 2012. *ASSIST recommends...Flicker Parameters for Reducing Stroboscopic Effects from Solid-state Lighting Systems*. Volume 11, Issue 1. Lighting Research Center: Troy, N.Y. Internet: <http://www.lrc.rpi.edu/programs/solidstate/assist/recommends/flicker.asp>
- Alliance for Solid-State Illumination Systems and Technologies (ASSIST). 2014. *ASSIST recommends...Application Considerations Related to Stroboscopic Effects from Light Source Flicker*. Volume 11, Issue 2. Lighting Research Center: Troy, N.Y. Internet: <http://www.lrc.rpi.edu/programs/solidstate/assist/recommends/flicker.asp>
- Bodington, D., A. Bierman, and N. Narendran. In press. A flicker perception metric. *Lighting Research and Technology*, published online before print 13 April 2015; doi 10.1177/1477153515581006.
- Eastman, A.A., and J.H. Campbell. 1952. Stroboscopic and flicker effects from fluorescent lamps. *Illuminating Engineering* 47: 27–35.
- Rea, M.S. (editor). 2000. *IESNA Lighting Handbook: Reference and Application*, 9th edition. New York: Illuminating Engineering Society.

Acknowledgments

ASSIST and the Lighting Research Center would like to thank the following for their review and participation in the development of this publication: Jean Paul Freyssonier and Jennifer Taylor.

About ASSIST

The Alliance for Solid-State Illumination Systems and Technologies (ASSIST) was established in 2002 by the Lighting Research Center as a collaboration among researchers, manufacturers, and government organizations. ASSIST's mission is to enable the broad adoption of solid-state lighting by providing factual information based on applied research and by visualizing future applications.

Appendix A – Light Flicker Detection Threshold Spectrum

The following table lists the temporal modulation threshold values for detecting flicker (50% detection rate) as a function of modulation frequency. The data were obtained from a population of 10 subjects (4 male; ages ranging from 22 to 64 years with mean = 41), viewing an A-lamp stimulus at a 0.7 m viewing distance placed in front of a gray background.

Table A1. Human detection thresholds for flicker at different frequencies

Sinusoid frequency (Hz)	Threshold value, modulation (%)
5	0.85
10	0.57
15	0.54
20	0.76
25	1.20
40	5.68
60	56.16

Other frequency values between 5 Hz and 65 Hz can be obtained by fitting above points with the 5th order polynomial function shown in equation A1, where f is the frequency of interest.

$$M_{DTH} = 0.01254 - 0.0007571f - 0.00004007f^2 + 0.000006757f^3 - 0.00000023306f^4 + 0.000000002958f^5 \quad (\text{Eq. A1})$$

The value of the fitted polynomial function equals approximately 100%, the highest possible modulation, at 65 Hz. Using this particular weighting function, values outside the range $5 \leq f \leq 65$ Hz are not used in the perceived flicker metric calculation.

Appendix B – Example of Implementation of the Flicker Perception Metric Calculation as a Matlab® Function

A copy and paste version of this code is available for download from the ASSIST recommends webpage: <http://www.lrc.rpi.edu/programs/solidstate/assist/recommends/flicker.asp>

```
function [Mp,f,Mpk,M] = LRCFlickerMetric(waveform,Srate)
% Function for calculating LRC Flicker Perception Metric
%
% Input arguments:
% waveform: column vector containing waveform values
% Srate: sample rate of waveform in Samples/s (Hz)
%
% Output variables:
% Mp: Perceived Modulation (the LRC Flicker Metric)
% f: Vector of frequency values in Hz
% Mpk: Spectral perceived modulation vector (1 = detection threshold)
% M: Spectral modulation vector (values in percent modulation)

% Originally created by Dashiell Bodington on 25-Sep-2013
% Last updated and modified by Andrew Bierman on 13-Jan-2015

if ~(rem(length(waveform),2) == 0) % if the length is not even
    waveform = waveform(1:end-1); % make length an even number
end

% Modulation detection threshold spectrum
SF = [5 10 15 20 25 40 60]; % Frequencies, Hz
ST = [0.846 0.568 0.542 0.759 1.198 5.677 56.157]/100; % Threshold values
% Interpolate sensitivity with 5th degree polynomial
P = polyfit(SF, ST, 5);
% 5th order polynomial nearly the same fit and not badly conditioned as is
% 6th degree

% Fourier Transform
X = abs(fft(waveform)); % abs computes component amplitudes of complex fft

% One-sided transform values expressed as a ratio of the dc value (Weber
% temporal contrast)
M = 2*X(1:length(X)/2+1)/X(1);

% Calculate Frequency Axis
f = (Srate/2)*linspace(0,1,length(M))';

% Human sensitivity weighting, Modulation detection threshold (Mdth)
Mdth = NaN*ones(size(f)); % Initialize array to not-a-number values
for i=1:length(f)
    if(f(i) <= 65 && f(i) >= 5) % 65 is where extrapolated modulation=100%
        Mdth(i) = (P(1)*f(i)^5) + (P(2)*f(i)^4) + (P(3)*f(i)^3) + ...
            (P(4)*f(i)^2) + (P(5)*f(i)) + P(6);
    end
end

% Apply human sensitivity weighting (i.e., divide by modulation detection
% threshold)
Mpk = M./Mdth;
Mpk(isnan(Mdth)) = 0; % Replace not-a-number values with zero

% Summation resulting in single-number metric
Mp = sqrt(sum(Mpk.^2));
end
% End of program -----
```

Appendix C – Example of a Matlab® Script to Calculate and Display the Components of the Flicker Perception Metric

A copy and paste version of this code is available for download from the *ASSIST recommends* webpage: <http://www.lrc.rpi.edu/programs/solidstate/assist/recommends/flicker.asp>

```
% Script for calling LRCFlickerMetric(waveform,Srate)

% Ask for location of LIGHT waveform file and upload it
disp('Loading data...')
message = 'Select file with light waveform information';
[filename1,pathname1] = uigetfile('*.txt',message);
fid = fopen([pathname1 filename1], 'r');
C = textscan(fid, '%f%f', 'Delimiter', '\t'); % C is a cell structure
fclose(fid);
Time = C{1}; % the first element of C is the array of time values
waveform = C{2}; % the second element of C is the array of waveform values
disp('Loading data complete...')

% Calculate LRC Flicker Metric
Srate = 1/(Time(2)-Time(1));
[Mp,f,Mpk,M] = LRCFlickerMetric(waveform,Srate);
disp(['LRC Flicker Metric: ' num2str(Mp, '%.2f')]); % Display Flicker Metric
% Calculate probability of flicker perception and display
PP = 100/(1 + exp(-5.4*(Mp - 1.04)));
disp(['Probability of flicker perception = ' num2str(PP, '%.0f') '%'])

% Calculate Flicker Percent
flickerPercent = (max(waveform) - min(waveform))/(max(waveform) + ...
    min(waveform))*100;
disp(['Flicker Percent: ' num2str(flickerPercent, '%.2f')]);

% Calculate Flicker Index
flickerIndex = sum(waveform(waveform > mean(waveform)) - ...
    mean(waveform))/sum(waveform);
disp(['Flicker Index: ' num2str(flickerIndex, '%.2f')]);

% Create figure window
%scrsz = get(0,'ScreenSize');
figure(1)
set(gcf, 'Position', [200,50,1000,860]);
% Plot waveform
subplot(3,1,1)
plot(Time,waveform,'b-', 'LineWidth',2);
axis([Time(1) Time(end) min(waveform)*.95 max(waveform)*1.05]);
title('Light Waveform', 'FontSize',14);
xlabel('Time (s)', 'FontSize',14);
ylabel('Signal (V)', 'FontSize',14);
set(gca, 'FontSize',14);

%Plot unweighted modulation components
subplot(3,1,2);
%plot(f,M*100,'b-', 'LineWidth',2);
bar(f,M*100);
set(gca, 'FontSize',14);
hLegend = legend('Unweighted components', 'Location', 'NorthEast');
set(hLegend, 'FontSize',12);
set(gca, 'XLim', [5,130]);
%title('Flicker Percent Spectrum', 'FontSize',14)
xlabel('Frequency (Hz)', 'FontSize',14);
ylabel('Spectral Flicker Percent', 'FontSize',14);

%Plot weighted frequency content
subplot(3,1,3)
%plot(f,Mpk, 'r', 'LineWidth',2)
```

```
bar(f,Mpk,'r');
hold on
plot([0,max(f)], [1,1], 'k', 'LineWidth', 2) % Plot threshold line x = 1
hold off
set(gca, 'FontSize', 14)
hLegend = legend('Weighted Percent Flicker Spectrum', ...
    'Flicker Threshold', 'Location', 'NorthEast');
set(hLegend, 'FontSize', 12);
set(gca, 'XLim', [5, 130]);
set(gca, 'YLim', [0, 2]);
xlabel('Frequency (Hz)', 'FontSize', 14)
ylabel('Spectral Perceptual Flicker', 'FontSize', 14)
% Add text information to graph
hold off
figure(1)
xpos = 82;
H1 = text(xpos, 0.7, ['Flicker percent = ' num2str(flickerPercent, '%.1f') ...
    ' %']);
H2 = text(xpos, 0.5, ['Flicker index = ' num2str(flickerIndex, '%.1f') ' %']);
H3 = text(xpos, 1.3, ['LRC Flicker Metric = ' num2str(Mp, '%.1f')]);
H4 = text(xpos, 1.1, ['Detection probability = ' num2str(PP, '%.0f'), ' %']);
set(H1, 'FontSize', 14, 'FontWeight', 'bold');
set(H2, 'FontSize', 14, 'FontWeight', 'bold');
set(H3, 'FontSize', 16, 'FontWeight', 'bold');
set(H4, 'FontSize', 14, 'FontWeight', 'normal');
% End of program -----
```