



High Precision Rotation Luminaire Goniophotometer (LSG-1890B/LSG-1800A)

Brochure

Global Office of Lisun Electronics Inc.

<http://www.Lisungroup.com>

Lisun Group (Hong Kong) Limited

Add: Room 803, Chevalier House, 45-51 Chatham Road South, Tsim Sha Tsui, KL, HK

Tel: 00852-68852050 Fax: 00852-30785638

Email: SalesHK@Lisungroup.com

Lisun Electronics (Shanghai) Co., Ltd

Add: 113-114, No. 1 Building, Nanxiang Zhidi Industry Park, No. 1101, Huyi Road, Jiading District, Shanghai, 201802, China

Tel: +86(21)5108 3341 Fax: +86(21)5108 3342

Email: SalesSH@Lisungroup.com

Lisun Electronics Inc. (USA)

Add: 445 S. Figueroa Street, Los Angeles, CA 90071, U.S.A.

Email: Sales@Lisungroup.com

Lisun China Factory

Add: NO. 37, Xiangyuan Road, Hangzhou City, Zhejiang Province, China

Tel: +86-189-1799-6096

Email: Engineering@Lisungroup.com

Leader in Lighting & Electrical Test Instruments

Rev. 7/4/2023

System Configuration

A. Goniophotometric System:

- Goniometric Rotating Console:
 - 1) LSG-1890B: Japanese Mitsubishi Motor and German Angle encoder System to keep the test accuracy to 0.1degree
 - 2) LSG-1800A: Taiwan Motor and Angle encoder System to keep the test accuracy to 0.2degree
- The LSG-1890B has Goniometric Rotating Control Instrument in 19inch cabinet: It connects to the PC and was controlled by the software.
- The LSG-1890B/LSG-1800A has Goniometric Rotating Control Android App which can control it to rotating angle in the dark room easily.
- High Precision Photometer with Class A Constant Temperature Photo Detector (Option is Class L)
- Cross-beam Laser System for Calibrating
- English Measuring Software
- Three sets of luminaries Clamps: multi-functions
- Oversea Delivery and Packing: all of the instruments and accessories will be packed with Fumigation free three plywood, include the delivery cost to Shanghai sea port

B. SLS-150W DC Standard Light Intensity Lamp

C. Digital Power Meter:

- 1) LSG-1890B has LS2050B Digital Power Meter: With LCD screen display, it is used to test AC/DC voltage, current, power, PF, DF and Harmonic
- 2) LSG-1800A has LS2012 Digital Power Meter: It is used to test AC/DC voltage, current, power and PF

D. DC3010 CC & CV DC Power Source: DC3010 output is 30V/10A, Option can be DC6010 (output is 60V/10A) and DC12010 (output is 120V/10A)

E. AC Power Source: LSP-500V ARC Pure Sine Wave AC Power Source with LCD Screen: 500VA Output. It can communicate with PC via software

F. CASE-19IN 19inch Standard Instruments Cabinet.

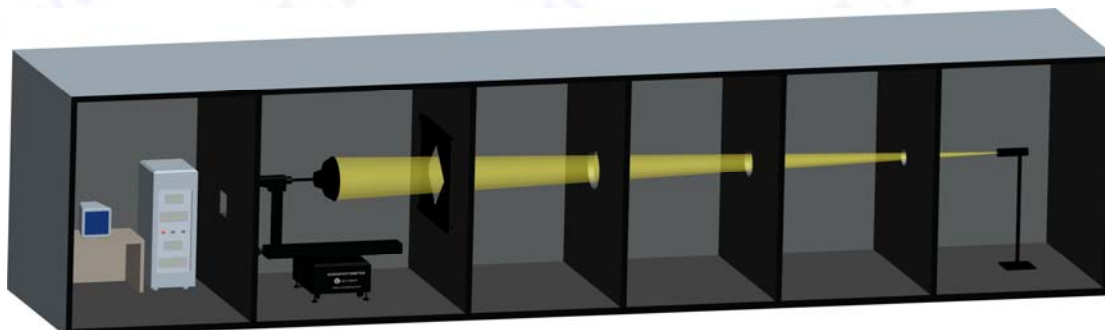

Full View for High Precision Rotation Luminaries Goniophotometer

Note: PC and Printer prepared by the customer (request at least two USB ports)

2. Working Principle

Goniophotometric System carries out measuring methods of fixed location and rotating luminaries. The measured luminaries is installed on the rotating supported, the center of which is in line with the rotating supporter center with the help of Laser sight. The fixed photometry detector is testing the luminous intensity in various horizontal directions, while the light source rotating. The mechanical equipment allows turning the tested luminaries around a vertical axis and a horizontal axis. When the luminaries under test turn around horizontal axis, the detector which is at the same level with rotating table will measure the intensity of each direction at this surface. When rotating with vertical axis, the detector will measure the intensity at the vertical surface. The vertical and horizontal axis can be rotated continuously at $-180^{\circ} \sim +180^{\circ}$. According to the measurement requirements, the system can be operated in B- β , A- α and C- γ coordinates. When getting intensity distribution data, computer will calculate other photometric parameters automatically.

Double pillars structure (B- β , A- α coordinate system)

This type is applied to fixed grille lamp. The symmetry axis of lamp and the horizontal of rotating supporter is coaxial in the B- β coordinate system, and the two is vertical Cross in the A- α coordinate system.

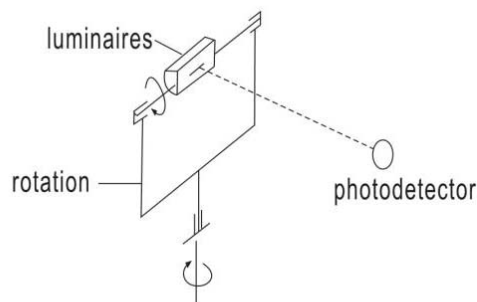
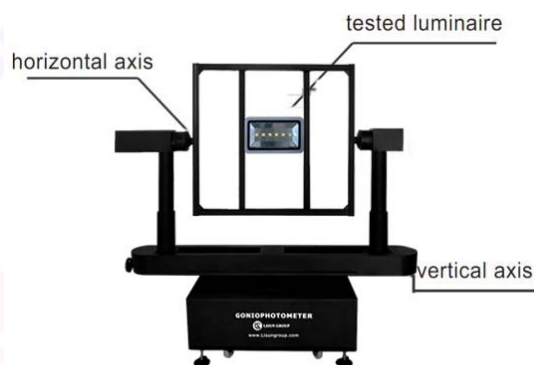

Double pillars structure

Single pillar structure (C- γ coordinate and Conic coordinate)

The single column structure will be gotten when the assistant column is taken down from double columns structure. This type is applied to fixed tube lamp, spot lamp etc. The axis radiation of lamp and the horizontal of rotating supporter is coaxial.

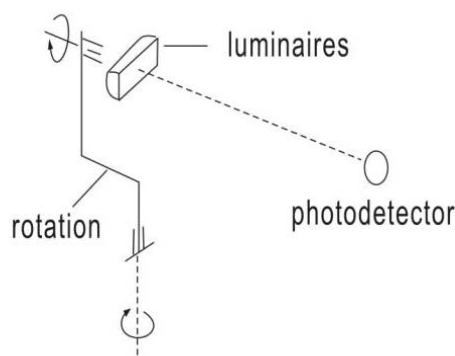

3. System Functions

LSG-1890B/LSG-1800A Goniophotometer is high precision automatic goniophotometric instrument for luminous intensity distribution measurements with facility for turning the light source. [The LSG-1890B uses a constant temperature detector, Japanese Motor and Germany precision angle coder which keep high test accuracy.](#) It is for industrial laboratory measurements the photometric data of luminaries.



Be utilized to measure photometric parameters of luminaries for LED road lighting fixture, room lighting fixture and projecting lighting fixture, such as spatial intensity distribution curve, spatial iso-intensity curve, intensity distribution curve on each section (represent by right-angled coordinates or polar coordinates, luminance limitation curve, luminaries efficiency, glare grade, effective beam angle, upward luminous flux ratio, downward luminous flux ratio, total luminous flux, effective luminous flux, utilization factor and electric parameters voltage, current, wattage, power factor and etc. The measured data meets IES standard format and can be applied for lighting design by lighting design software. The measurement system fully satisfies the requirement of lighting design work.



4. Specifications

- Meets the requirements of CIE, IEC, IES LM-79 & GB standards
- Reaching many measurement ways such as B-β and C-γ
- Test Max Luminaires size and weight: LSG-1890B is 2000mm/60kg and LSG-1800A is 1600mm/50kg
- The tested luminaires rotates around an angle of (γ)±180°(or 0-360°) and the tested luminaires rotates around itself with an angle of (C)±180°(or 0-360°)
- Luminosity Testing Range: Illuminance 0.001lx~99,999lx; Light Intensity 1.0cd~10⁷cd(detector)
- Angle accuracy: LSG-1890B is 0.1°, LSG-1800A is 0.2°
- Photometry Accuracy: CIE Class A (Class L is option)
- Testing Accuracy: 2%(Under Standard lamp); Stray Light: less than 0.1%
- English version software can run in Win7, Win8 or Win10, Win11

5. Laboratory Requirements

LISUN MODEL	Center Height (A)	Total Height (B)	Total Depth (C)	Total Width (D)	The max size for the Testing Lamp: Diameter(E)*Depth(F)	The max diameter of the mast rotating(G)	Max Testing Weight
LSG-1890B	1510	1600	922	1750	∅2000x600max *	∅2000	60kg
LSG-1800A	1370	1420	750	1650	∅1600x600max	∅1700	50kg

Table 1 The Dimensions of the Goniophotometer Master

*Note: The max testing lamp size depends on the dark room height and special design jig (option)

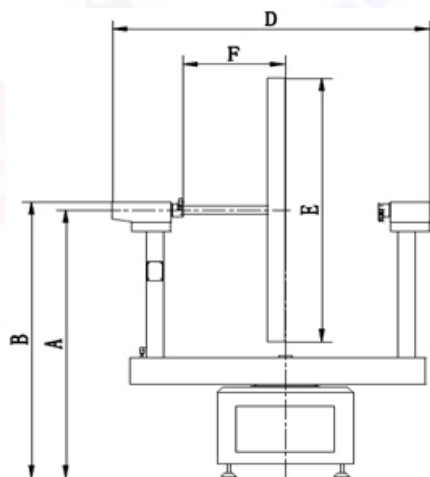

Figure 1 The Side View

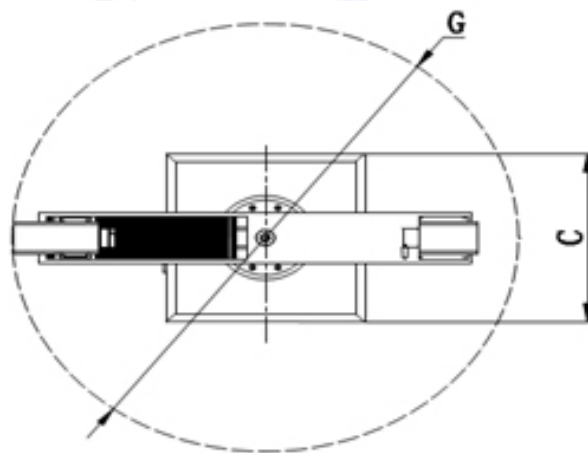
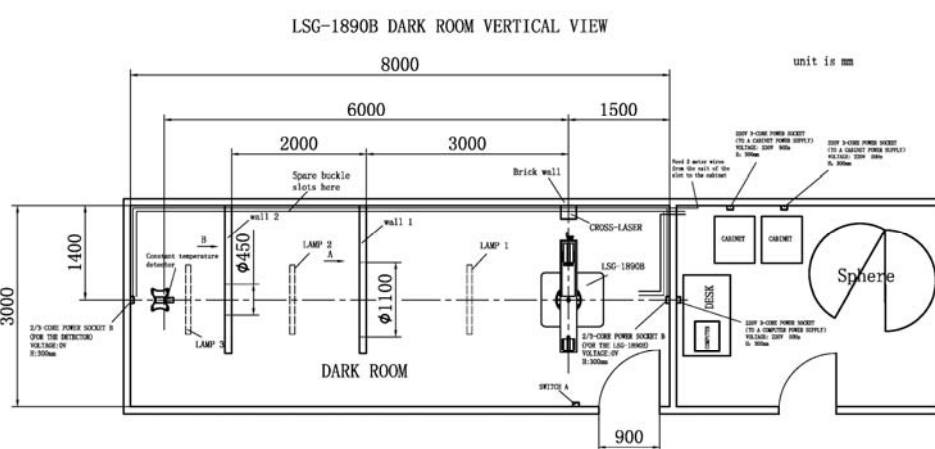

Figure 2 The Vertical View

- Dark Room size request (The G, A and E please refer to the above table 1 and figure 1 and 2): The darkroom Width W=G+X (It recommends the X is min 500mm which can allow one person pass). The darkroom Height H=A+0.5*E+Y (It recommends the Y is min 100mm to the ceiling). The darkroom Length L=6*E (According to CIE, it requests at least 6times than the testing lamps).

- **Control Room size request:** min=2000*2000*2000mm
- The wall, ceiling and floor should be all coated with dull black paint or be covered by black cloth and black carpet.
- Air-conditioner should be set in the dark room to control the temperature around lamps to the standard value upon the CIE requirements
- LISUN engineer dept will submit the Lab Design support documents according to the customer's lab size after the purchase order was confirmed (The below are two Typical Lab Design reference for LSG-1890B/LSG-1800A). **NOTE: The longer dark room, the better test accuracy. LISUN recommends you to prepare as longer dark room as you can (max 30m)**



Technical requirements:

1. The walls and ceiling of the darkroom need to be painted matte black. Cover the floor with black carpet.
2. The wires for 3-core power socket A and 2/3-core power socket B are inside of the buckle slot from the cabinet. Need 2 meter wires from the exit of the slot to the cabinet. Another buckle slot at the same place for backup.
3. Switch A is for lamp 1, lamp 2 and lamp 3. Lamps should be installed on the ceiling.
4. The 3-Core power socket for LSG-1890B must be well grounded or connected with the separate earthing terminal.
5. The dotted line buckle slot need to be easy tear open outfit and matte black.
6. The wall for cross laser is better to be brick. The cross laser together with the holder is about 5kg and need to be fixed on the wall.
7. Diameter of all wires are at least 2mm^2 .
8. The air conditioner outlet must not close to the luminaries being measured or the light path.
9. The windows need to be blocked or covered by matte black curtain.
10. The width of dark room door above 900mm, so that LSG-1890B could enter into dark room.

LSG-1800A DARK ROOM VERTICAL VIEW

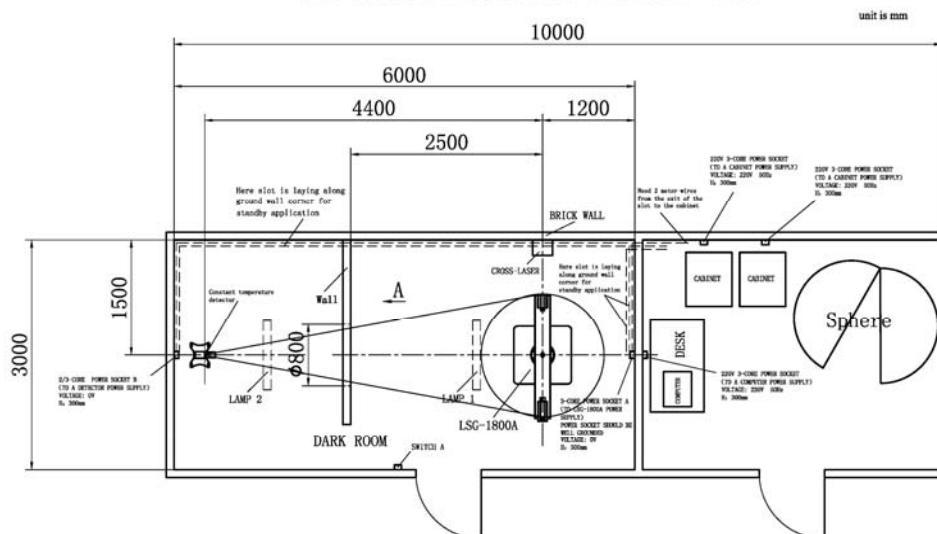
**Technical requirement:**

1. The walls, floors and ceilings of dark room must painted matt black paint and the ground spreads black carpet .
2. The power lines of three-core power socket A and two / three-core power socket B laying along the wall and into the operating room, requires power line head exposed ground 2 meter, the other slot laying along and enter into operating room for standby application.
3. SwitchA used to control lamp 1, lamp 2, Lamp installed in the ceiling.
4. Three-core power socket A (Power to LSG-1800A) must be well grounded, or separate ground terminal .
5. The slot where is referring by dotted line should be detachable, and the width of the slot should be not less than 50mm .
6. The wall to install cross laser must be brick wall.
7. The windows are sealed off in the darkroom to make sure light cannot leak absolutely.
8. In the dark room where LSG-1800A main machine placed, the air outlet of air set should not directly face to the tested lamp and the optical path.
9. All wire diameter $\geq 2\text{mm}^2$.

6. Typical oversea market customers:

There are many world famous companies and lab institute choose Lisun Goniophotometer, Please get the reference customers' information from Lisun Group Oversea Sales Dept.

7. Design Standard of Device

The construction, technical parameter, test & operate steps as well as data processing software of goniophotometer meet the following requirements:

- CIE Pub. NO.70, "The Measurement of Absolute Luminous Intensity Distributions"
- CIE DIV. II -TC10, "Photometry of Luminaires"
- IES LM-35-1989, "IES Approved Method for Photometric Testing of Floodlights"
- IES LM-31, "IES Approved Method for Photometric Testing of Roadway Luminaires"
- IES-LM-79-19, "Electrical and Photometric Measurements of Solid-State Lighting Products"
- GB/T 7002-1986, "Luminosity Test of Flood Luminaires"
- GB/T 9467-1988, "Luminosity Test of Indoor Luminaires"
- GB/T 9468-1988, "Luminosity Test of Street Luminaires"
- IES 61341 "Method of Measurement of Center Beam Intensity and Beam Angle(s) of Reflector Lamp"
- CIE Pub. NO.76, "Photometry-the CIE System of Physical Photometry"

8. Application Software

All control of the goniophotometer operations can be realized by the software, including gonophotometer movement, data acquisition and processing, real-time display on screen, report print and etc, thus enabling the measurement easy and secure.

This system can export data files as following formats:

IESNA Files (*.ies)
EULUMDAT Files (*.ldt)
CIEBSE TM14 Files (*.cib)
CIEBSE TM14 Files (*.tm4)
CIE Files (*.cie)
DIN CEN Files (*.cen)
Excel File (*.csv)

This kind of format files can be transferred by other illumination and luminaries design software such as DiaLux

Application software can also implement essential calculation for lighting design as iso-illuminance distribution curve on a working plane, luminance limitation curve, luminary's efficiency, effective beam angle, upward luminous flux ratio, downward luminous flux ratio, effective luminous flux, utilization factor curve etc.

The Next Page is the Test Report by software

Report No. : LISUN-001

Test Time : 2023-01-03 14:12:36

Page 1 of &&

Lisun Goniophotometer Test Report

Product Info

 Luminaire Category : **Roadway**

 Luminaire : **AK-KH120**

 Lamp Category : **CREE**

 Lamp : **011507**

 Manufacturer : **Philips Lighting B.V.**

 Submitter : **Michael Aslami**

 Number of Lamps : **1**

 Lumens per Lamp : **2100 lm**

 Luminous Length : **20 mm**

 Luminous Width : **15 mm**

 Luminous Height : **5 mm**

Electric Parameters

 Voltage : **230.00 V** Current : **0.1813 A** Power : **21.60 W** Power Factor : **0.518** Frequency : **50.00 Hz**

Photometric Parameters

 IES Classification : **Type II**

 Total Rated Lamp Lumens : **2100.0 lm**

 Efficiency : **94.85 %**

 Downward Ratio : **94.85 %**

 Maximum Intensity : **1097.62 cd**

 Luminaire Efficacy Rating (LER) : **92**

 Beam Angle (C0-C180) : **133.9 °**

 Field Angle(C0-C180) : **145.5 °**

 Longitudinal Classification : **Short**

 Measurement Flux : **1991.9 lm**

 Upward Ratio : **0.00 %**

 Central Intensity : **576.11 cd**

 Position Of Maximum Intensity : **C0° γ61°**

 Energy Efficiency Class : **F (EU 2019/2015 η_{TM}:92lm/W)**

 Beam Angle (C90-C270) : **95.9 °**

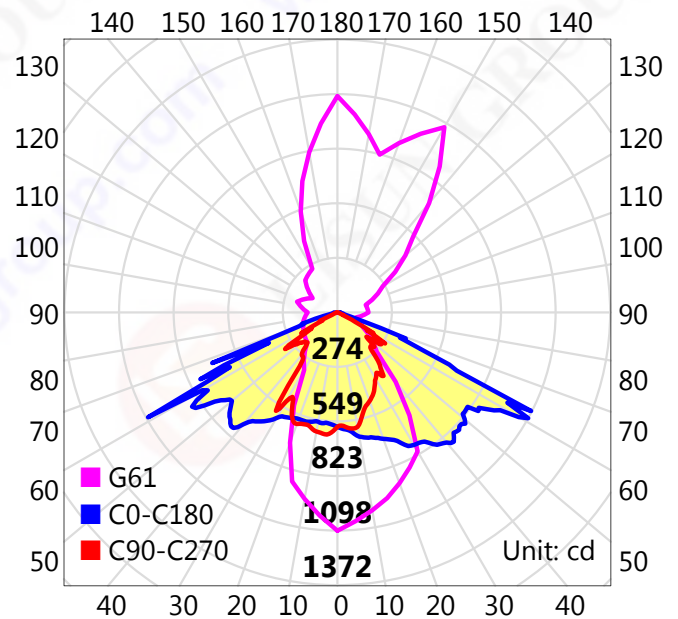
 Field Angle(C90-C270) : **127.9 °**

Test Type : Type C

Test Distance : 8.460 m

C Plane (°): 0.0-360.0:15.0 γ (°): 0.0-90.0:1.0

Test Device : LSG-18906

Temperature : 25°C

Humidity : 65.0%

Test Lab : LISUN GROUP

Test By : Thomas Fiodorow

Review By :

Report No. : LISUN-001

Test Time : 2023-01-03 14:12:36

Page 2 of 22

Light Distribution Curve

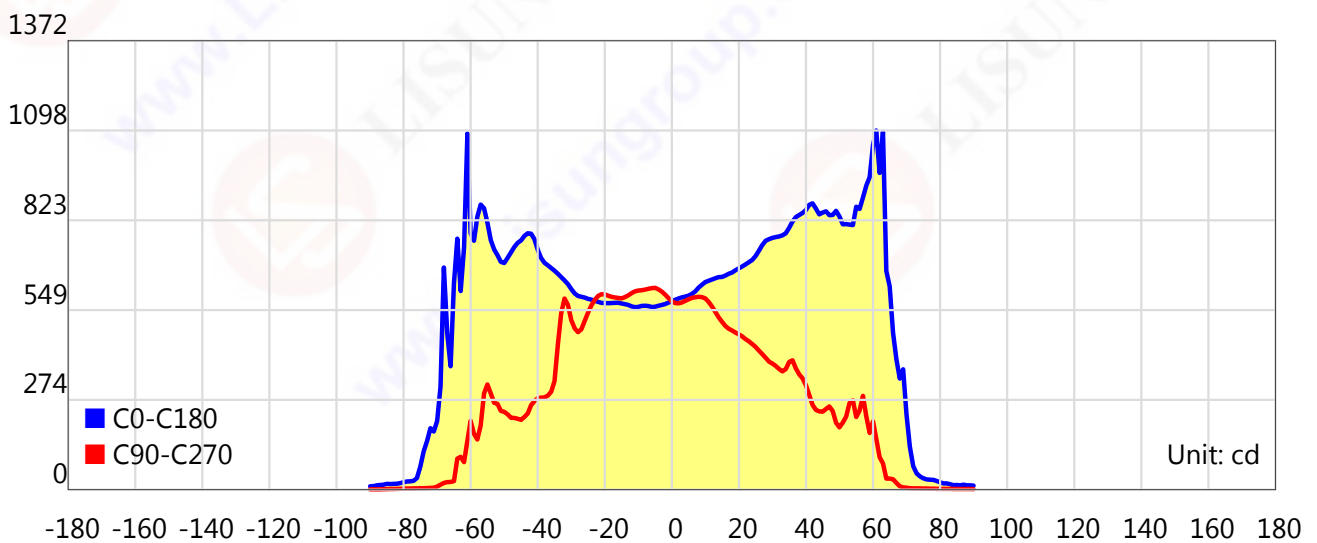
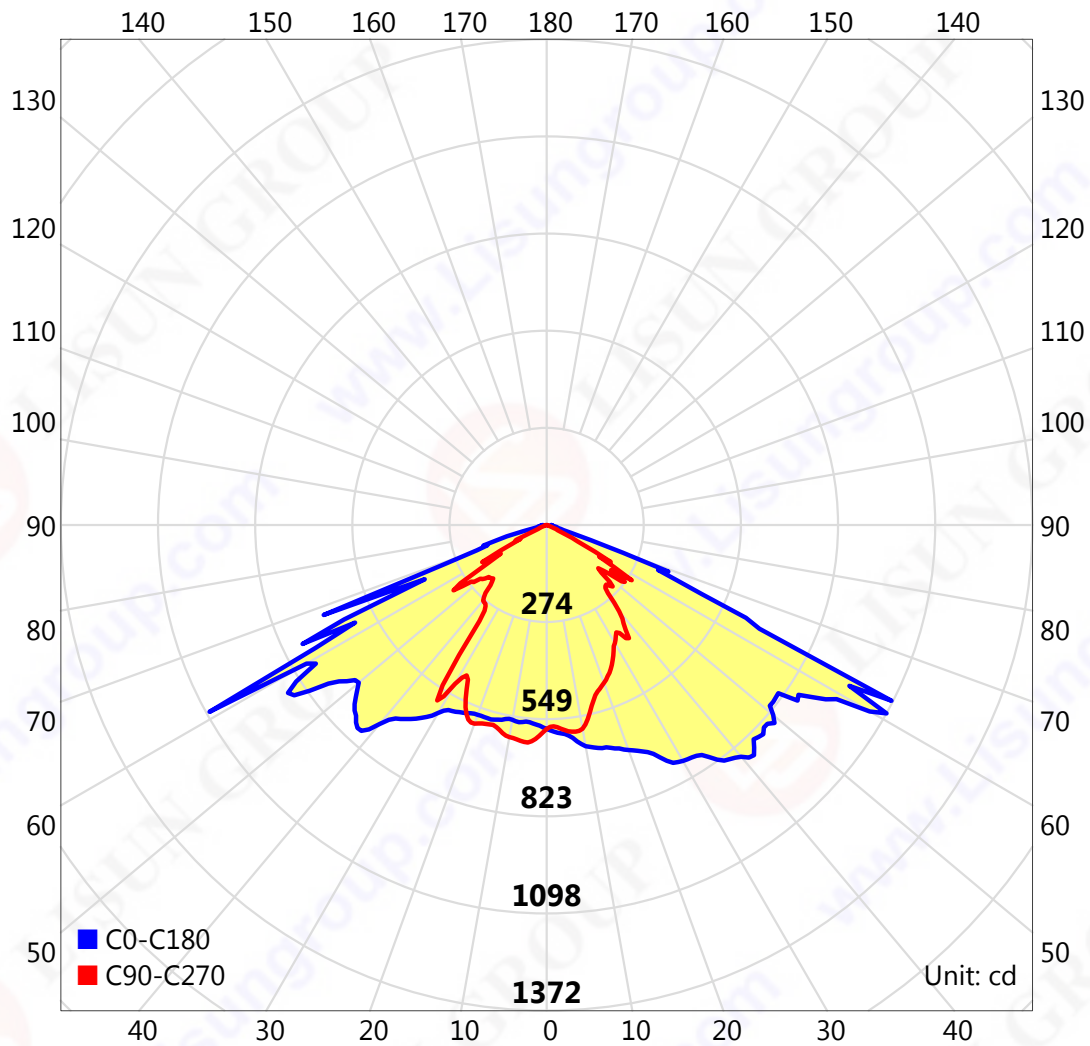
 Test Type : Type C
 Test Device : LSG-1890B
 Test Lab : LISUN GROUP
 Test By : Thomas Fiodorow

Test Distance : 8.460 m

 C Plane (°): 0.0-360.0:15.0
 Temperature : 25°C

 γ (°): 0.0-90.0:1.0
 Humidity : 65.0%

Review By :

Light Distribution Curve (cd/klm)

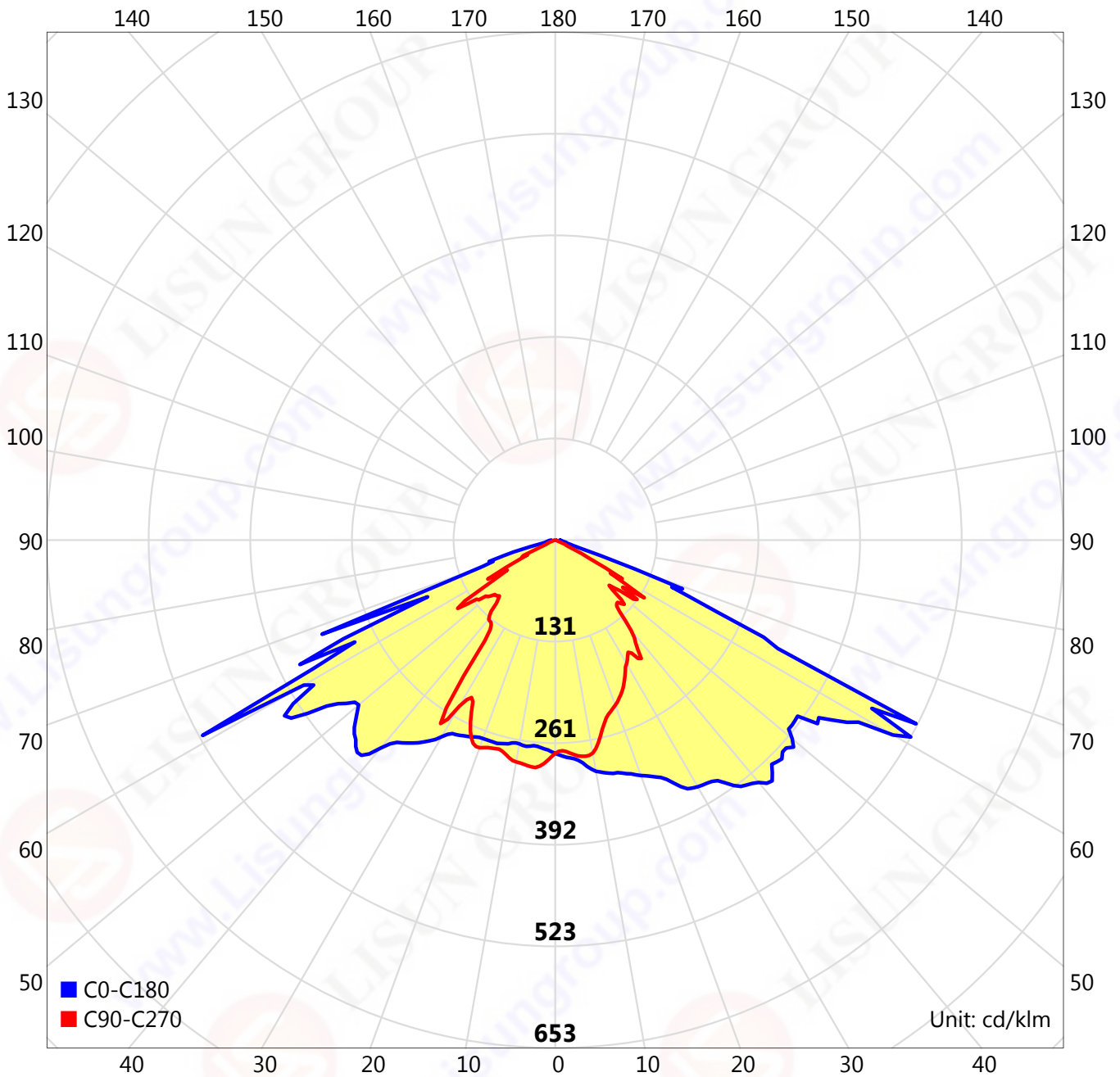

011507/CREE

$\eta=94.85\%$

Report No. : LISUN-001

Test Time : 2023-01-03 14:12:36

Page 4 of 22

Warmup Log

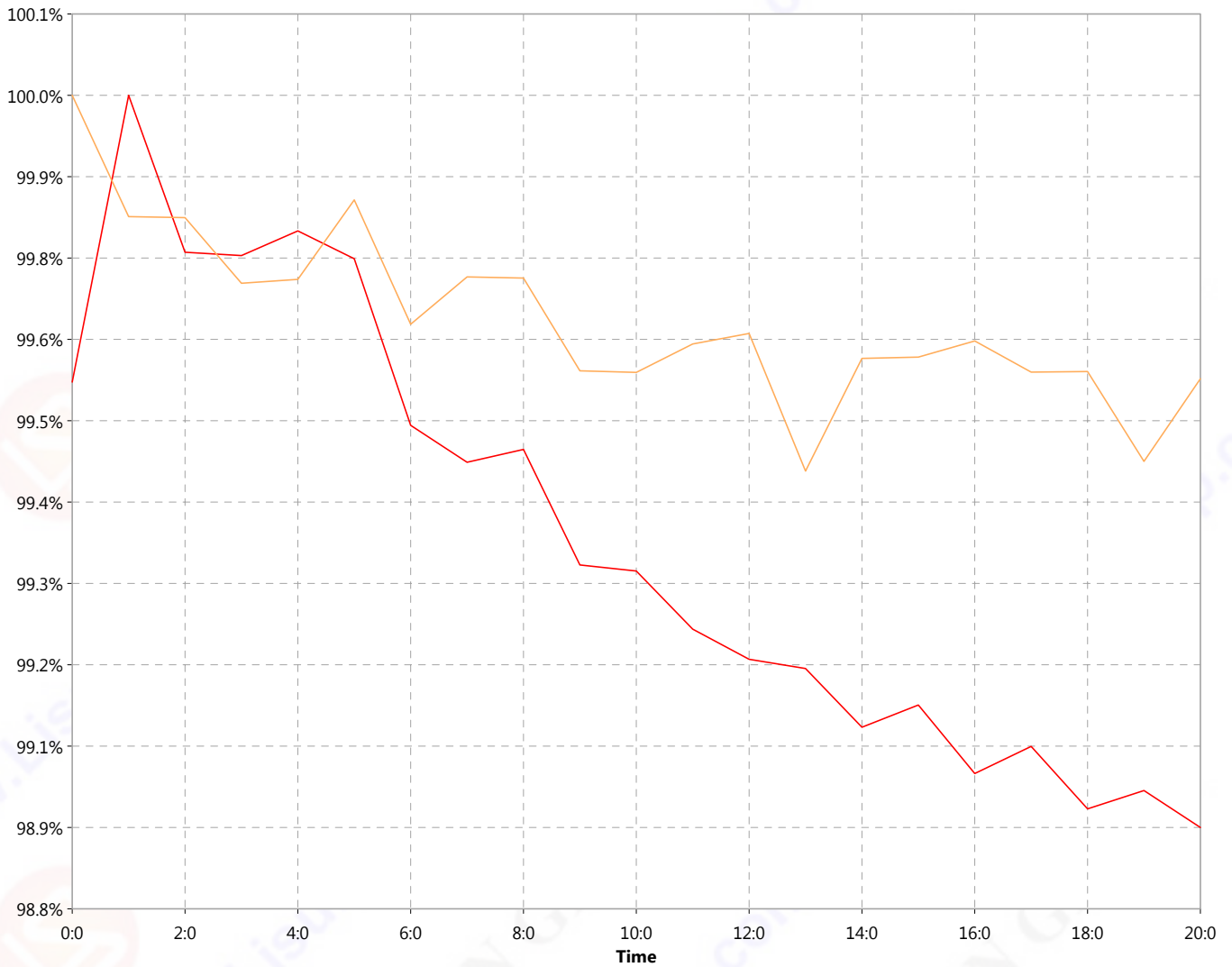

Stable time: 20:0

Uptime: 0:0

Parameters	Maximum	Minimum	Change
Luminous intensity ,cd	582.69	576.51	6.18
Power ,W	21.72	21.60	0.12

Test Type : Type C

Test Distance : 8.460 m

C Plane (°): 0.0-360.0:15.0

γ (°): 0.0-90.0:1.0

Test Device : LSG-1890B

Temperature : 25°C

Humidity : 65.0%

Test Lab : LISUN GROUP

Test By : Thomas Fiodorow

Review By :

Roadway CU

Efficiency (%)

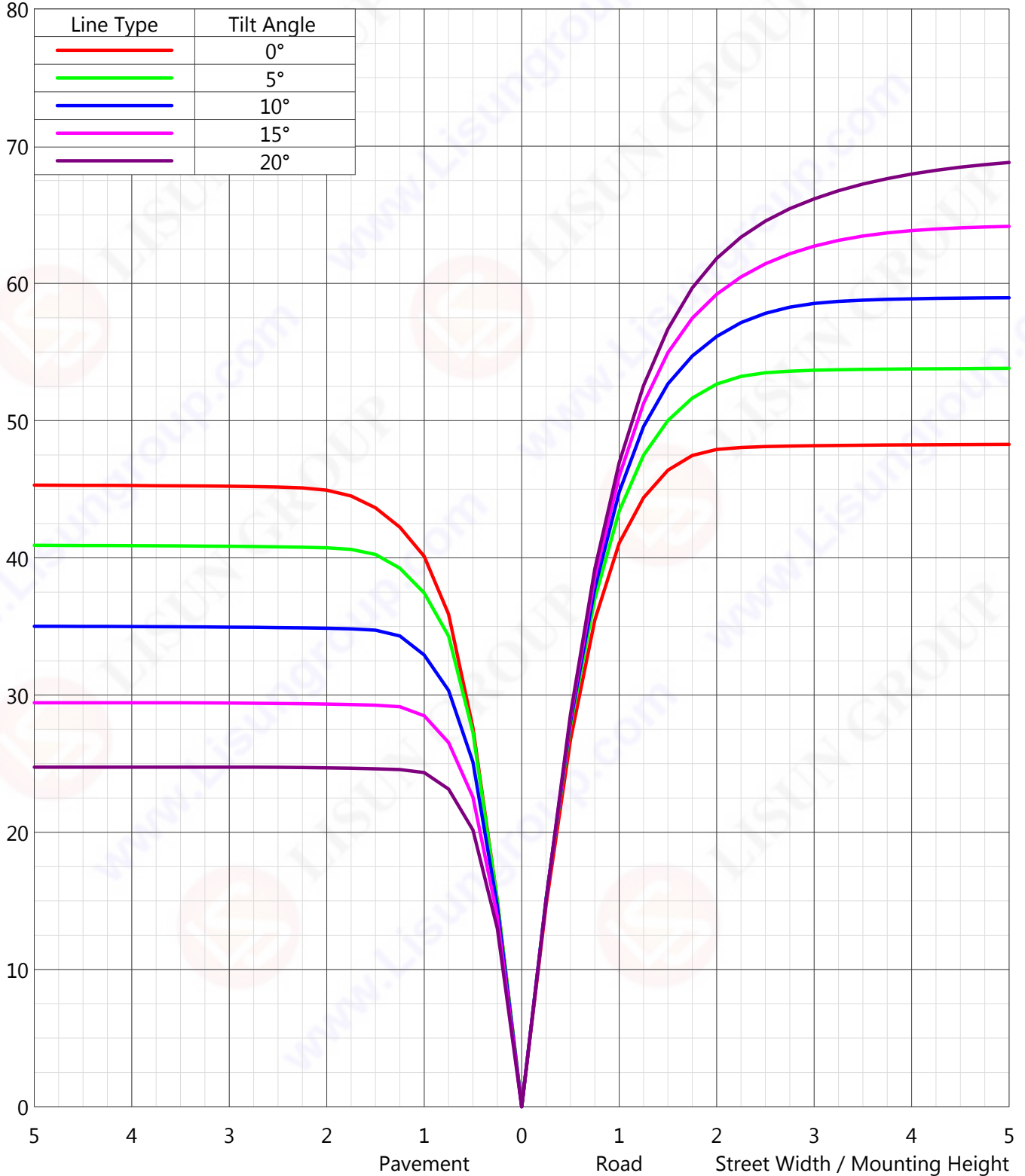

BUG Ratings

ZONE	LUMENS	% LAMP LUMENS
FORWARD LIGHT	1022	48.7
FL (0°-30°)	233	11.1
FM (30°-60°)	601	28.6
FH (60°-80°)	183	8.7
FVH (80°-90°)	5	0.2
BACK LIGHT	970	46.2
BL (0°-30°)	260	12.4
BM (30°-60°)	593	28.2
BH (60°-80°)	113	5.4
BVH (80°-90°)	4	0.2
UP LIGHT	0	0.0
UL (90°-100°)	0	0.0
UH (100°-180°)	0	0.0
TRAPPED LIGHT	108	5.1

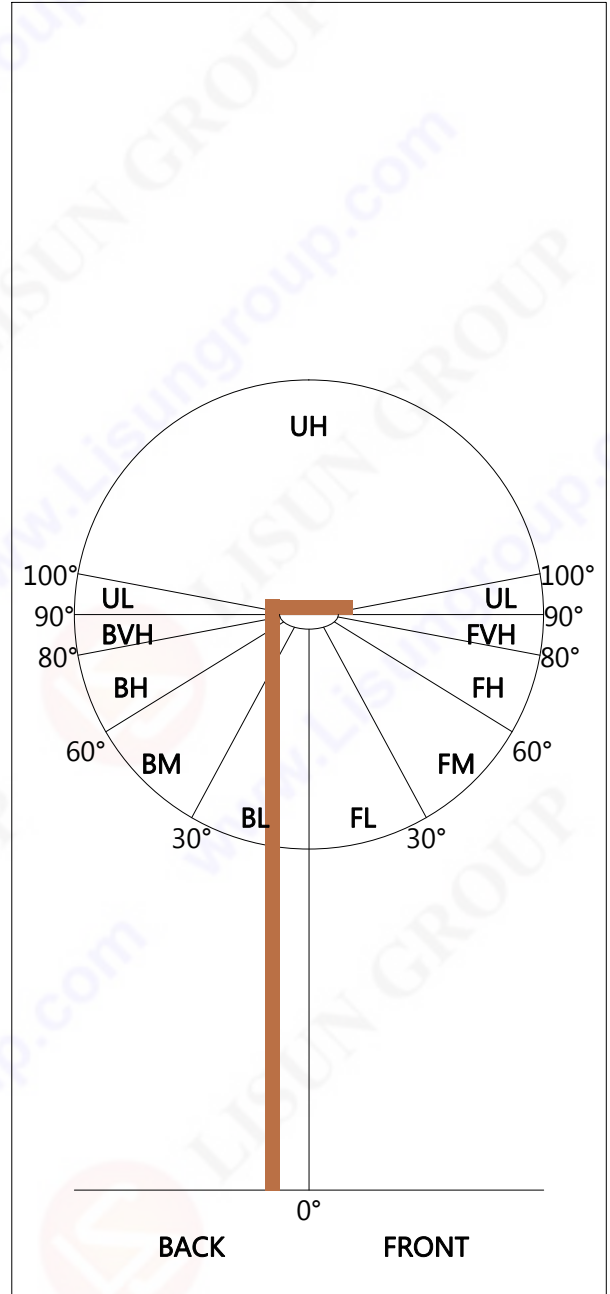

BUG(Backlight,Uplight,Glare) Rating Base On	TM-15-07	TM-15-11
Asymmetrical Luminaire Types (Type I,II,III,IV)	B1 U0 G1	B1 U0 G1
Quadrilateral Symmetrical Luminaire Types (Type V,Area Light)	B1 U0 G0	B1 U0 G0

Report No. : LISUN-001

Test Time : 2023-01-03 14:12:36

Page 7 of 22

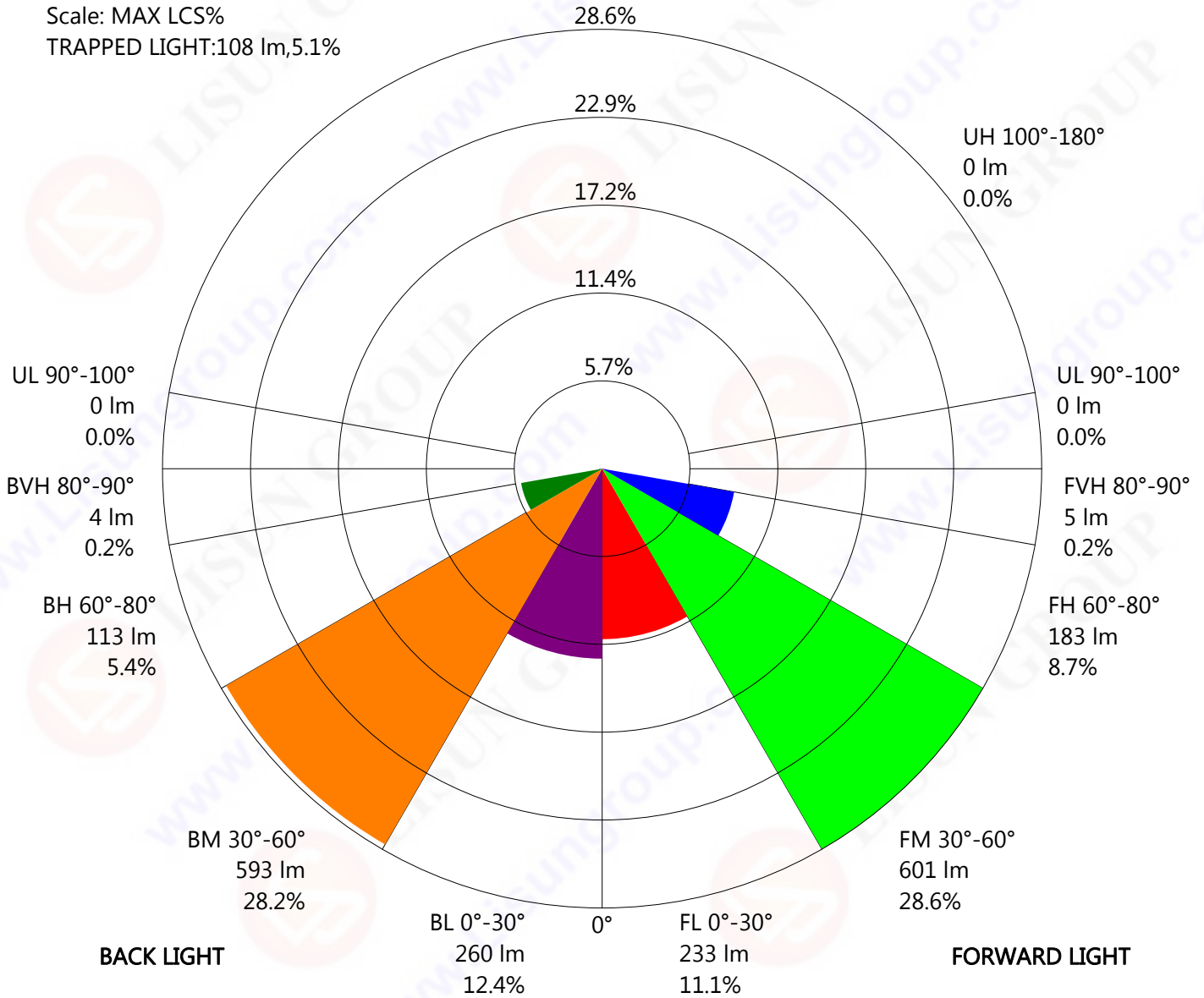
LCS Graph

 Test Type : Type C
 Test Device : LSG-1890B
 Test Lab : LISUN GROUP
 Test By : Thomas Fiodorow

Test Distance : 8.460 m

 C Plane (°): 0.0-360.0:15.0 γ (°): 0.0-90.0:1.0
 Temperature : 25°C Humidity : 65.0%

Review By :

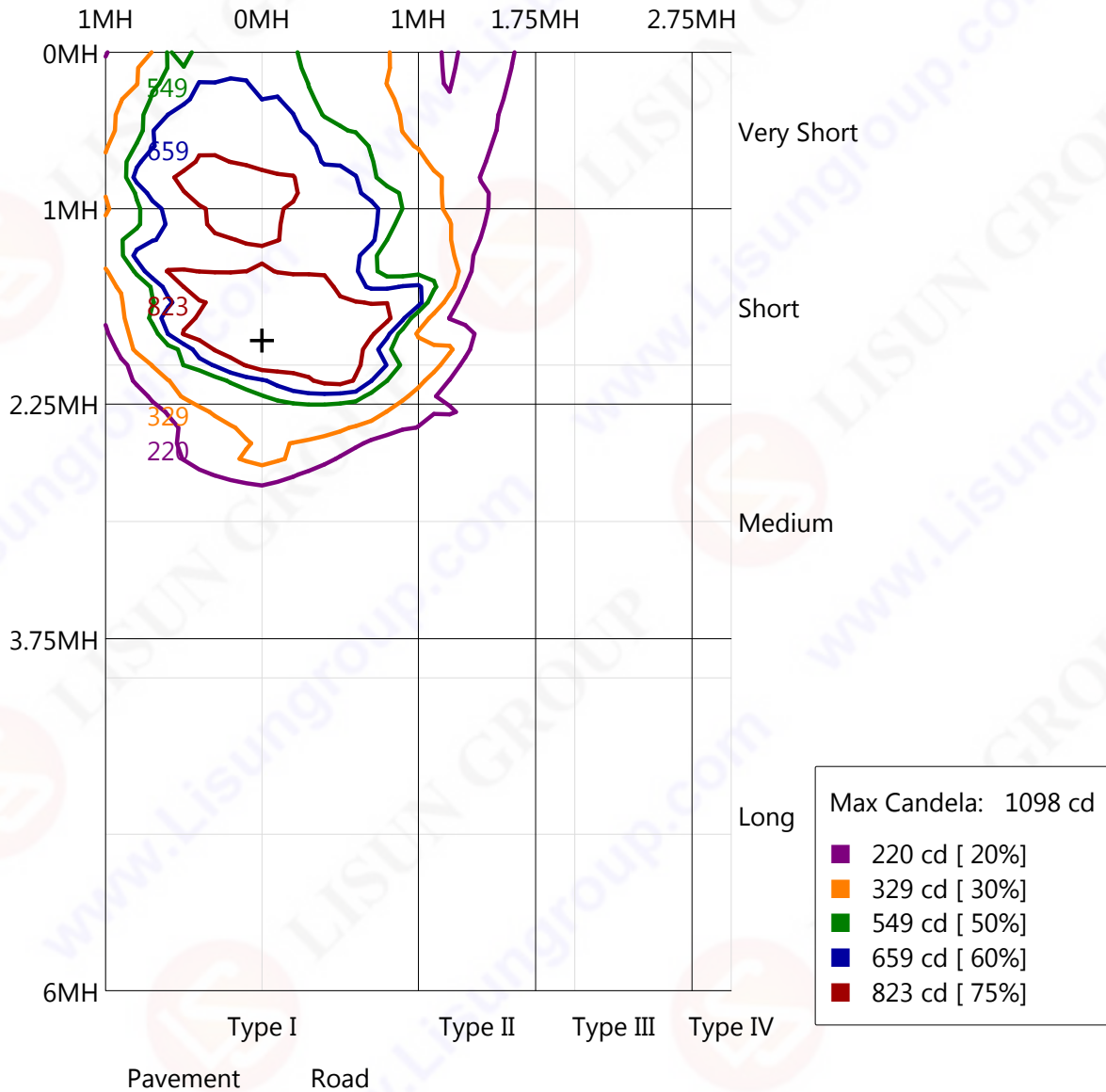
Road Surface IsoCandela Diagram

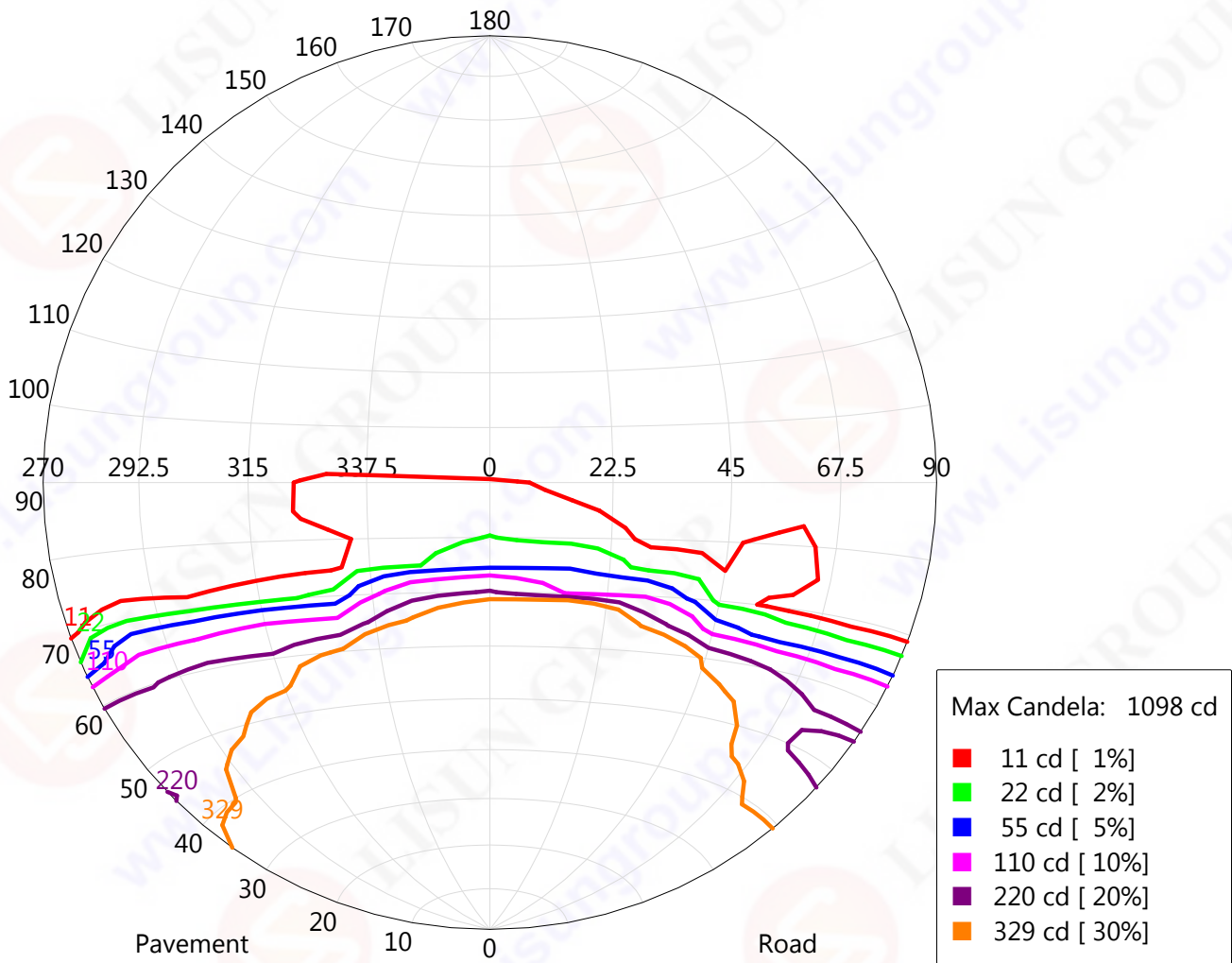

IsoCandela

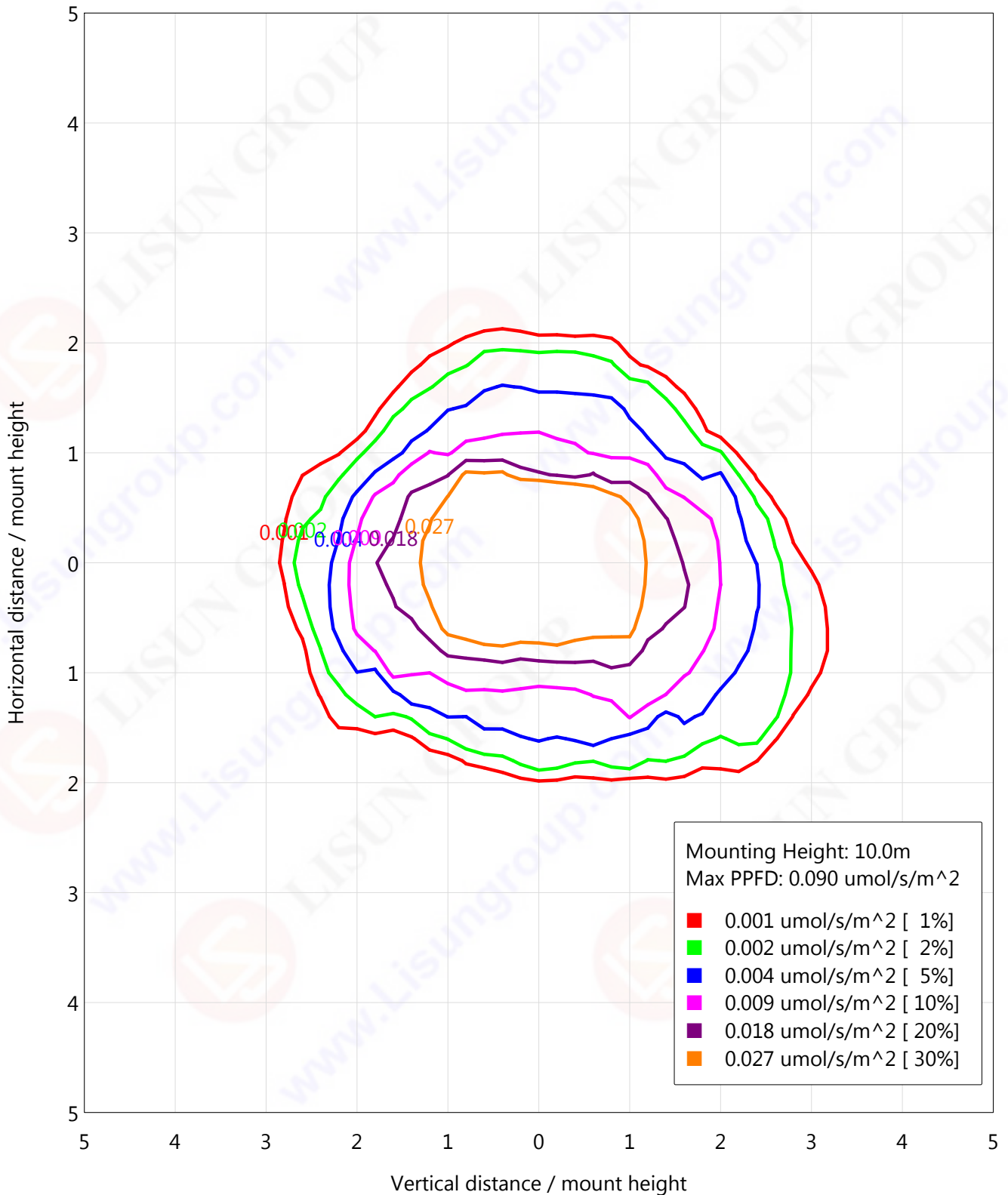
IsoPPFD

Report No. : LISUN-001

Test Time : 2023-01-03 14:12:36

Page 11 of 22

Zonal Flux

Gamma °	I _{mean} cd	Zonal Flux lm	Sum Zonal Flux lm	Rel Zonal Flux %	Sum Rel Zonal Flux %
0.0-1.0	576.6	0.6	0.6	0.03	0.03
1.0-2.0	578.3	1.7	2.2	0.08	0.11
2.0-3.0	581.5	2.8	5.0	0.13	0.24
3.0-4.0	585.4	3.9	8.9	0.19	0.42
4.0-5.0	589.3	5.1	14.0	0.24	0.67
5.0-6.0	593.0	6.2	20.2	0.30	0.96
6.0-7.0	596.6	7.4	27.6	0.35	1.32
7.0-8.0	600.5	8.6	36.2	0.41	1.72
8.0-9.0	603.7	9.8	46.0	0.47	2.19
9.0-10.0	605.2	11.0	57.0	0.52	2.71
10.0-11.0	605.2	12.1	69.0	0.58	3.29
11.0-12.0	604.0	13.2	82.3	0.63	3.92
12.0-13.0	601.7	14.3	96.5	0.68	4.60
13.0-14.0	598.8	15.3	111.9	0.73	5.33
14.0-15.0	595.5	16.4	128.2	0.78	6.11
15.0-16.0	592.6	17.4	145.6	0.83	6.93
16.0-17.0	590.3	18.4	164.0	0.88	7.81
17.0-18.0	588.6	19.4	183.4	0.92	8.73
18.0-19.0	587.4	20.4	203.8	0.97	9.71
19.0-20.0	586.7	21.5	225.3	1.02	10.73
20.0-21.0	586.6	22.5	247.8	1.07	11.80
21.0-22.0	586.5	23.6	271.4	1.12	12.92
22.0-23.0	586.4	24.6	296.0	1.17	14.10
23.0-24.0	585.9	25.6	321.6	1.22	15.32
24.0-25.0	584.3	26.6	348.2	1.27	16.58
25.0-26.0	581.2	27.4	375.6	1.31	17.89
26.0-27.0	576.9	28.2	403.9	1.34	19.23
27.0-28.0	572.4	29.0	432.8	1.38	20.61
28.0-29.0	569.5	29.8	462.6	1.42	22.03
29.0-30.0	569.6	30.8	493.4	1.46	23.50
30.0-31.0	572.8	31.9	525.3	1.52	25.01
31.0-32.0	577.4	33.1	558.4	1.58	26.59
32.0-33.0	582.1	34.3	592.7	1.63	28.22
33.0-34.0	583.6	35.3	628.0	1.68	29.90
34.0-35.0	579.6	36.0	664.0	1.71	31.62
35.0-36.0	575.2	36.6	700.6	1.74	33.36
36.0-37.0	572.4	37.3	738.0	1.78	35.14
37.0-38.0	567.1	37.9	775.8	1.80	36.94
38.0-39.0	561.8	38.3	814.2	1.83	38.77
39.0-40.0	560.2	39.1	853.2	1.86	40.63

Test Type : Type C

Test Distance : 8.460 m

C Plane (°): 0.0-360.0:15.0

γ (°): 0.0-90.0:1.0

Test Device : LSG-1890B

Temperature : 25°C

Humidity : 65.0%

Test Lab : LISUN GROUP

Test By : Thomas Fiodorow

Review By :

Report No. : LISUN-001

Test Time : 2023-01-03 14:12:36

Page 12 of 22

Zonal Flux

Gamma °	Imean cd	Zonal Flux lm	Sum Zonal Flux lm	Rel Zonal Flux %	Sum Rel Zonal Flux %
40.0-41.0	560.7	39.9	893.2	1.90	42.53
41.0-42.0	558.2	40.6	933.7	1.93	44.46
42.0-43.0	553.0	41.0	974.7	1.95	46.41
43.0-44.0	546.6	41.3	1016.0	1.96	48.38
44.0-45.0	539.9	41.5	1057.5	1.98	50.35
45.0-46.0	532.7	41.7	1099.1	1.98	52.34
46.0-47.0	523.4	41.6	1140.8	1.98	54.32
47.0-48.0	513.4	41.5	1182.3	1.98	56.30
48.0-49.0	504.9	41.5	1223.7	1.97	58.27
49.0-50.0	496.8	41.4	1265.2	1.97	60.25
50.0-51.0	489.0	41.4	1306.5	1.97	62.22
51.0-52.0	482.2	41.4	1347.9	1.97	64.19
52.0-53.0	478.8	41.7	1389.6	1.98	66.17
53.0-54.0	477.4	42.1	1431.7	2.00	68.17
54.0-55.0	476.8	42.6	1474.2	2.03	70.20
55.0-56.0	475.4	43.0	1517.2	2.05	72.25
56.0-57.0	471.5	43.1	1560.3	2.05	74.30
57.0-58.0	461.9	42.7	1603.0	2.03	76.33
58.0-59.0	447.2	41.8	1644.8	1.99	78.33
59.0-60.0	447.5	42.3	1687.1	2.01	80.34
60.0-61.0	455.9	43.5	1730.6	2.07	82.41
61.0-62.0	425.4	41.0	1771.6	1.95	84.36
62.0-63.0	366.6	35.7	1807.3	1.70	86.06
63.0-64.0	314.1	30.8	1838.1	1.47	87.53
64.0-65.0	280.5	27.8	1865.9	1.32	88.85
65.0-66.0	252.2	25.2	1891.0	1.20	90.05
66.0-67.0	202.8	20.4	1911.4	0.97	91.02
67.0-68.0	155.9	15.8	1927.2	0.75	91.77
68.0-69.0	123.7	12.6	1939.9	0.60	92.37
69.0-70.0	102.1	10.5	1950.3	0.50	92.87
70.0-71.0	82.6	8.5	1958.9	0.41	93.28
71.0-72.0	60.7	6.3	1965.2	0.30	93.58
72.0-73.0	43.8	4.6	1969.8	0.22	93.80
73.0-74.0	32.2	3.4	1973.2	0.16	93.96
74.0-75.0	24.4	2.6	1975.7	0.12	94.08
75.0-76.0	18.5	2.0	1977.7	0.09	94.18
76.0-77.0	14.9	1.6	1979.3	0.08	94.25
77.0-78.0	13.0	1.4	1980.7	0.07	94.32
78.0-79.0	11.8	1.3	1981.9	0.06	94.38
79.0-80.0	10.8	1.2	1983.1	0.06	94.43

Test Type : Type C

Test Distance : 8.460 m

C Plane (°): 0.0-360.0:15.0

γ (°): 0.0-90.0:1.0

Test Device : LSG-1890B

Temperature : 25°C

Humidity : 65.0%

Test Lab : LISUN GROUP

Test By : Thomas Fiodorow

Review By :

Zonal Flux

Gamma °	I _{mean} cd	Zonal Flux lm	Sum Zonal Flux lm	Rel Zonal Flux %	Sum Rel Zonal Flux %
80.0-81.0	9.9	1.1	1984.2	0.05	94.49
81.0-82.0	9.2	1.0	1985.2	0.05	94.53
82.0-83.0	8.8	1.0	1986.1	0.05	94.58
83.0-84.0	8.4	0.9	1987.1	0.04	94.62
84.0-85.0	8.2	0.9	1988.0	0.04	94.66
85.0-86.0	8.0	0.9	1988.8	0.04	94.71
86.0-87.0	7.7	0.8	1989.7	0.04	94.75
87.0-88.0	7.4	0.8	1990.5	0.04	94.78
88.0-89.0	6.7	0.7	1991.2	0.03	94.82
89.0-90.0	6.2	0.7	1991.9	0.03	94.85

Light Distribution Data

Unit: cd

G\C	C0.0	C15.0	C30.0	C45.0	C60.0	C75.0	C90.0	C105.0
G0.0	576.1	576.1	576.1	576.1	576.1	576.1	576.1	576.1
G1.0	580.2	578.3	576.7	576.4	573.5	575.3	570.6	573.6
G2.0	584.2	579.6	577.2	577.6	574.0	578.2	569.4	574.1
G3.0	587.6	580.3	578.4	579.6	576.7	582.9	572.0	579.5
G4.0	590.1	582.5	579.4	586.5	581.0	587.8	576.9	584.3
G5.0	593.0	586.5	583.7	593.2	586.5	593.9	581.7	588.6
G6.0	598.4	592.7	589.4	600.8	592.3	597.0	586.3	590.8
G7.0	605.9	600.7	596.5	606.9	597.4	598.3	588.3	591.4
G8.0	617.3	610.9	608.4	613.8	600.0	598.4	589.8	590.5
G9.0	626.6	621.0	617.5	618.8	601.0	597.5	588.8	584.8
G10.0	634.4	631.7	624.4	620.8	600.9	594.0	584.5	573.2
G11.0	638.4	638.6	630.8	623.9	601.7	587.2	574.2	559.1
G12.0	642.6	644.3	637.3	627.4	599.5	574.3	560.0	545.1
G13.0	646.5	649.9	642.3	627.1	594.0	559.3	543.1	530.2
G14.0	649.8	653.4	645.5	623.4	586.5	544.6	526.5	516.7
G15.0	650.5	659.8	646.9	617.7	576.4	526.3	512.9	501.2
G16.0	654.7	662.9	650.0	608.8	564.5	514.0	500.1	488.9
G17.0	660.1	663.1	653.2	597.8	553.6	504.6	492.0	480.1
G18.0	664.0	664.3	656.2	586.8	546.2	498.9	486.5	473.1
G19.0	670.9	666.6	659.1	576.2	541.2	493.5	480.1	468.2
G20.0	676.8	669.0	661.8	569.2	536.5	487.4	474.5	462.7
G21.0	682.1	670.8	662.8	564.7	531.8	479.8	468.7	457.8
G22.0	688.4	674.3	660.6	562.2	525.7	474.5	460.7	452.1
G23.0	695.1	681.6	656.7	562.4	517.3	472.9	453.8	446.8
G24.0	702.2	690.2	651.4	564.0	509.2	471.6	445.4	442.9
G25.0	713.7	697.3	645.6	562.2	503.8	470.0	436.3	436.9
G26.0	730.7	703.8	639.5	557.8	501.1	464.5	425.1	427.3
G27.0	747.5	710.8	634.2	551.2	502.0	457.8	414.4	415.1
G28.0	761.0	719.0	631.7	545.1	504.2	448.3	403.1	404.1
G29.0	765.9	728.6	634.5	541.2	503.9	433.1	391.6	396.0
G30.0	769.6	741.9	642.2	541.2	499.0	421.8	385.7	390.5
G31.0	772.2	754.4	651.0	545.9	493.0	413.3	378.2	382.5
G32.0	774.1	765.1	658.1	552.6	487.1	407.0	369.2	374.1
G33.0	777.4	774.9	659.8	558.0	481.7	400.9	361.8	369.5
G34.0	784.1	780.5	658.1	560.6	481.1	399.6	368.6	371.7
G35.0	800.6	784.5	654.0	559.5	482.0	418.2	390.7	375.6
G36.0	819.4	789.1	646.9	555.9	477.1	436.5	395.4	373.9
G37.0	833.3	794.5	640.0	561.6	465.7	414.7	370.7	376.5
G38.0	839.7	801.9	638.4	583.5	455.3	372.6	352.6	382.8
G39.0	846.0	817.7	643.4	610.6	456.6	343.0	340.0	390.2

Test Type : Type C

Test Distance : 8.460 m

C Plane (°): 0.0-360.0:15.0

γ (°): 0.0-90.0:1.0

Test Device : LSG-1890B

Temperature : 25°C

Humidity : 65.0%

Test Lab : LISUN GROUP

Test By : Thomas Fiodorow

Review By :

Report No. : LISUN-001

Test Time : 2023-01-03 14:12:36

Page 15 of 22

Light Distribution Data

Unit: cd

G\C	C0.0	C15.0	C30.0	C45.0	C60.0	C75.0	C90.0	C105.0
G40.0	854.8	835.9	652.9	624.6	476.3	308.8	318.9	386.7
G41.0	870.6	846.6	664.6	617.7	473.8	284.3	290.2	361.5
G42.0	875.3	841.3	685.4	597.4	444.9	276.0	259.3	308.2
G43.0	859.4	824.6	708.4	573.9	399.6	273.0	243.7	271.8
G44.0	841.7	803.8	734.3	562.2	357.7	258.9	239.5	249.9
G45.0	847.0	799.0	752.0	559.0	341.4	253.9	238.3	233.9
G46.0	850.9	803.5	747.1	543.7	327.2	268.8	246.9	232.0
G47.0	839.1	798.7	732.0	514.1	312.1	262.3	254.8	242.5
G48.0	839.4	798.5	744.0	491.5	298.9	233.7	240.3	259.2
G49.0	852.5	820.2	763.5	494.4	302.1	220.2	204.7	277.6
G50.0	835.3	825.7	780.3	538.5	308.3	211.3	190.4	246.0
G51.0	811.3	793.7	769.1	543.8	301.4	226.4	205.4	210.7
G52.0	811.9	760.9	715.6	534.0	233.2	249.8	223.4	210.9
G53.0	810.5	751.0	703.0	538.9	249.2	282.5	265.0	229.4
G54.0	809.0	743.0	710.6	456.9	287.2	243.6	273.2	271.9
G55.0	864.8	793.3	631.6	376.5	275.6	227.5	222.4	308.9
G56.0	858.0	842.6	537.7	356.3	284.5	250.5	241.7	289.2
G57.0	892.7	880.9	491.7	364.2	253.9	232.1	286.7	239.8
G58.0	929.4	868.5	490.6	352.1	219.8	209.0	224.0	178.9
G59.0	955.4	884.4	519.3	363.8	201.3	142.5	173.5	262.8
G60.0	1053.4	1000.1	654.5	305.2	219.4	183.4	209.3	233.4
G61.0	1097.6	967.1	807.2	281.1	148.6	97.7	156.4	148.0
G62.0	968.4	950.5	822.2	224.9	112.3	79.0	99.6	107.8
G63.0	1093.4	1073.3	463.6	154.5	101.2	44.5	80.6	82.3
G64.0	668.5	892.3	263.5	121.3	48.9	32.0	33.9	39.7
G65.0	621.3	968.8	303.0	77.0	37.6	32.1	33.9	40.0
G66.0	479.5	646.3	403.6	55.7	31.1	26.4	32.1	31.0
G67.0	398.5	493.4	253.2	43.7	23.7	13.9	20.9	20.3
G68.0	339.8	312.8	179.3	30.4	15.9	8.4	10.3	10.3
G69.0	368.3	192.6	241.0	17.8	9.5	6.7	7.0	8.2
G70.0	230.4	103.4	104.6	13.6	8.6	5.2	6.1	6.9
G71.0	131.4	89.6	37.1	12.4	8.5	4.9	4.8	6.5
G72.0	72.3	82.0	31.2	11.1	9.1	4.9	4.4	6.5
G73.0	50.0	62.9	24.9	11.3	10.0	5.1	4.1	6.2
G74.0	41.0	56.9	17.0	11.8	11.9	4.9	3.9	6.2
G75.0	35.2	49.1	13.8	11.0	14.0	4.3	3.7	6.2
G76.0	31.6	39.2	12.0	10.6	13.5	3.9	3.6	7.0
G77.0	30.6	27.1	11.8	10.4	12.3	3.8	3.2	7.1
G78.0	29.9	17.8	11.9	10.0	11.8	3.7	2.9	7.2
G79.0	26.9	14.7	10.3	9.6	12.6	3.5	2.9	7.7

Test Type : Type C

Test Distance : 8.460 m

C Plane (°): 0.0-360.0:15.0

γ (°): 0.0-90.0:1.0

Test Device : LSG-1890B

Temperature : 25°C

Humidity : 65.0%

Test Lab : LISUN GROUP

Test By : Thomas Fiodorow

Review By :

Report No. : LISUN-001

Test Time : 2023-01-03 14:12:36

Page 16 of 22

Light Distribution Data

Unit: cd

G\C	C0.0	C15.0	C30.0	C45.0	C60.0	C75.0	C90.0	C105.0
G80.0	22.6	15.0	9.9	10.5	12.8	3.4	2.8	7.7
G81.0	19.3	12.2	9.5	11.0	12.7	3.2	2.7	7.1
G82.0	19.2	9.9	9.5	10.5	11.1	3.1	2.5	6.5
G83.0	16.6	8.9	9.3	9.5	11.1	2.9	2.5	6.0
G84.0	14.0	9.2	9.3	8.6	10.7	2.7	2.4	5.4
G85.0	14.2	12.0	9.0	8.0	9.9	2.8	2.3	5.1
G86.0	13.3	11.0	7.5	8.4	9.2	2.6	2.2	4.8
G87.0	15.3	8.9	7.7	9.3	8.8	2.5	2.1	4.6
G88.0	13.3	9.3	8.5	8.2	7.8	2.3	2.1	4.2
G89.0	13.3	8.6	6.4	6.4	6.6	2.2	2.0	3.8
G90.0	12.6	9.3	5.2	6.9	6.1	2.0	1.8	3.5

Test Type : Type C

Test Distance : 8.460 m

C Plane (°): 0.0-360.0:15.0

γ (°): 0.0-90.0:1.0

Test Device : LSG-1890B

Temperature : 25°C

Humidity : 65.0%

Test Lab : LISUN GROUP

Test By : Thomas Fiodorow

Review By :

Report No. : LISUN-001

Test Time : 2023-01-03 14:12:36

Page 17 of 22

Light Distribution Data

Unit: cd

G\C	C120.0	C135.0	C150.0	C165.0	C180.0	C195.0	C210.0	C225.0
G0.0	576.1	576.1	576.1	576.1	576.1	576.1	576.1	576.1
G1.0	569.6	571.7	570.5	571.0	572.1	574.0	576.3	577.8
G2.0	566.7	568.7	565.7	565.7	567.4	571.3	578.0	580.5
G3.0	566.7	568.2	560.3	561.4	564.8	569.0	580.0	585.7
G4.0	569.1	568.3	557.8	556.8	562.2	569.8	581.4	589.6
G5.0	574.5	573.5	556.1	553.2	559.1	570.8	583.4	591.9
G6.0	579.3	577.9	556.5	551.3	558.3	570.1	585.8	591.9
G7.0	583.9	581.7	557.8	553.3	561.1	572.7	591.0	594.5
G8.0	586.3	583.6	561.2	553.1	562.5	576.8	594.1	598.4
G9.0	584.0	584.3	563.3	551.2	561.6	580.8	595.9	600.9
G10.0	578.2	584.2	565.0	551.1	558.8	583.8	597.2	600.7
G11.0	572.3	581.4	567.9	554.8	558.0	586.2	599.2	601.6
G12.0	564.3	577.7	573.0	559.3	560.3	586.3	601.4	600.5
G13.0	556.3	572.9	574.0	564.5	564.8	586.7	603.3	598.3
G14.0	544.8	564.4	573.8	568.5	567.0	589.7	606.6	593.7
G15.0	531.5	556.1	573.7	572.4	569.2	592.7	608.8	586.9
G16.0	516.6	548.0	572.1	574.8	571.5	596.2	609.1	579.0
G17.0	501.7	538.6	570.1	577.2	570.9	598.2	607.5	572.5
G18.0	491.3	529.3	568.1	577.5	570.7	598.4	604.3	569.9
G19.0	482.3	520.3	563.7	578.6	570.3	598.6	600.2	569.4
G20.0	474.3	513.4	559.1	581.6	570.8	597.6	594.8	572.3
G21.0	469.8	508.9	553.0	581.4	571.1	599.9	588.8	574.7
G22.0	467.2	503.3	548.9	580.9	573.9	603.3	582.1	571.2
G23.0	462.6	497.9	546.3	580.3	577.4	606.9	579.4	566.0
G24.0	458.4	494.2	544.2	579.3	580.8	609.5	576.2	564.3
G25.0	455.6	492.2	541.6	579.2	583.5	608.5	573.4	569.5
G26.0	452.3	490.7	538.9	582.3	587.1	608.1	571.6	581.5
G27.0	448.2	488.8	538.1	586.5	589.9	608.6	570.5	599.3
G28.0	440.6	486.3	537.8	589.7	592.1	611.4	570.3	611.5
G29.0	431.4	486.4	535.6	593.2	600.0	615.0	570.7	613.8
G30.0	423.7	485.6	534.6	603.3	613.3	620.9	571.9	607.3
G31.0	416.4	480.6	535.5	613.2	628.5	629.1	573.6	591.7
G32.0	415.0	476.4	533.2	623.4	639.6	634.7	576.7	570.6
G33.0	413.9	473.1	533.0	633.1	650.0	638.0	585.7	542.8
G34.0	411.2	467.8	536.9	642.0	660.3	639.1	605.9	512.4
G35.0	406.6	462.3	545.7	652.7	669.2	644.6	634.3	486.1
G36.0	404.2	459.0	555.0	668.2	677.7	655.9	658.3	471.6
G37.0	402.6	456.3	562.4	681.9	686.2	673.2	667.3	470.7
G38.0	402.2	455.7	569.0	695.9	693.7	683.2	665.5	476.9
G39.0	400.1	455.3	577.7	708.5	708.4	694.7	658.3	493.7

Test Type : Type C

Test Distance : 8.460 m

C Plane (°): 0.0-360.0:15.0

γ (°): 0.0-90.0:1.0

Test Device : LSG-1890B

Temperature : 25°C

Humidity : 65.0%

Test Lab : LISUN GROUP

Test By : Thomas Fiodorow

Review By :

Report No. : LISUN-001

Test Time : 2023-01-03 14:12:36

Page 18 of 22

Light Distribution Data

Unit: cd

G\C	C120.0	C135.0	C150.0	C165.0	C180.0	C195.0	C210.0	C225.0
G40.0	398.5	457.5	583.8	719.7	733.8	707.8	661.4	529.7
G41.0	403.4	460.9	592.9	730.5	765.3	717.6	669.7	564.2
G42.0	411.7	464.7	604.2	740.6	782.4	730.4	673.0	583.5
G43.0	433.3	469.7	615.3	750.4	784.1	743.4	666.4	628.1
G44.0	458.5	478.8	630.3	758.8	775.7	756.3	648.9	604.0
G45.0	468.2	494.9	660.0	764.6	761.7	760.5	638.9	528.4
G46.0	444.3	512.5	689.2	769.8	754.3	752.1	640.3	440.3
G47.0	389.5	529.2	717.0	774.0	741.9	731.3	652.8	367.4
G48.0	326.6	543.0	737.8	765.5	725.1	703.0	655.5	303.7
G49.0	281.7	577.3	751.9	741.3	708.7	676.4	650.0	270.7
G50.0	251.5	647.0	763.6	698.8	692.9	659.0	647.7	267.6
G51.0	245.5	688.2	760.2	677.5	696.5	662.9	663.8	269.0
G52.0	248.4	684.1	720.8	679.3	716.7	662.2	672.1	271.6
G53.0	291.0	638.7	673.8	701.1	734.5	674.4	621.2	273.7
G54.0	400.4	563.4	632.3	724.1	762.7	708.5	570.7	273.1
G55.0	378.5	540.6	620.4	775.4	816.3	730.7	567.2	261.4
G56.0	254.6	530.5	615.0	809.3	860.3	725.7	395.1	246.5
G57.0	246.9	534.0	673.8	857.6	871.5	666.7	276.9	245.3
G58.0	254.3	548.0	746.5	1026.1	834.4	654.9	270.0	224.6
G59.0	351.5	610.5	790.0	895.4	760.9	661.4	239.3	210.2
G60.0	462.9	641.3	1001.8	714.3	783.4	610.4	236.4	219.1
G61.0	263.5	539.2	1075.6	822.1	1088.7	683.6	252.9	229.7
G62.0	206.0	370.8	726.0	1043.3	739.6	542.6	231.6	204.2
G63.0	229.8	239.5	514.3	991.1	607.5	449.9	201.3	193.9
G64.0	241.1	312.8	600.5	559.9	767.1	627.9	167.3	155.4
G65.0	109.1	375.5	796.1	494.7	631.3	759.1	104.4	94.5
G66.0	54.5	354.6	673.0	925.8	377.3	513.5	93.4	84.1
G67.0	57.5	277.9	354.8	829.2	477.6	253.0	41.9	76.6
G68.0	46.8	144.7	415.0	491.2	679.3	151.0	30.2	54.6
G69.0	30.1	151.6	378.8	376.0	314.5	114.2	27.2	38.6
G70.0	15.3	112.3	516.2	530.7	209.8	88.8	23.7	18.2
G71.0	13.2	63.8	516.9	323.2	177.6	61.4	17.7	15.2
G72.0	12.5	30.8	199.9	383.0	187.9	41.2	11.9	12.2
G73.0	11.5	23.7	122.3	254.7	148.7	30.3	10.2	9.1
G74.0	10.3	20.6	89.0	171.7	117.7	22.3	9.3	7.5
G75.0	9.5	17.0	52.6	114.3	71.1	18.2	8.6	6.8
G76.0	8.8	13.9	45.8	73.6	35.9	17.9	8.1	7.0
G77.0	7.8	11.9	38.6	48.1	27.0	18.3	8.2	6.7
G78.0	8.0	10.0	31.2	40.4	25.8	16.5	8.0	6.5
G79.0	8.9	8.6	25.0	32.9	25.3	14.5	7.6	6.2

Test Type : Type C

Test Distance : 8.460 m

C Plane (°): 0.0-360.0:15.0

γ (°): 0.0-90.0:1.0

Test Device : LSG-1890B

Temperature : 25°C

Humidity : 65.0%

Test Lab : LISUN GROUP

Test By : Thomas Fiodorow

Review By :

Report No. : LISUN-001

Test Time : 2023-01-03 14:12:36

Page 19 of 22

Light Distribution Data

Unit: cd

G\C	C120.0	C135.0	C150.0	C165.0	C180.0	C195.0	C210.0	C225.0
G80.0	8.6	8.1	18.1	26.9	23.0	13.3	7.1	6.2
G81.0	8.0	7.9	13.3	23.2	20.3	13.2	5.9	6.3
G82.0	7.7	7.8	11.8	19.5	18.4	12.8	5.5	6.7
G83.0	6.8	7.7	10.9	16.1	17.6	12.9	5.2	6.8
G84.0	6.4	8.1	9.9	14.6	17.3	13.3	5.2	6.1
G85.0	6.5	7.9	8.6	13.5	17.6	12.9	5.5	5.6
G86.0	7.1	8.0	8.1	12.4	15.5	12.1	5.1	5.1
G87.0	6.7	8.0	7.2	11.6	14.6	10.2	4.7	4.9
G88.0	7.0	7.1	6.6	10.0	13.3	7.8	4.3	4.5
G89.0	6.5	5.6	5.7	8.9	10.8	7.2	4.1	4.1
G90.0	4.9	4.7	5.0	8.8	10.6	7.9	4.0	3.8

Test Type : Type C

Test Distance : 8.460 m

C Plane (°): 0.0-360.0:15.0

γ (°): 0.0-90.0:1.0

Test Device : LSG-1890B

Temperature : 25°C

Humidity : 65.0%

Test Lab : LISUN GROUP

Test By : Thomas Fiodorow

Review By :

Light Distribution Data

Unit: cd

G\C	C240.0	C255.0	C270.0	C285.0	C300.0	C315.0	C330.0	C345.0
G0.0	576.1	576.1	576.1	576.1	576.1	576.1	576.1	576.1
G1.0	580.9	581.3	585.1	582.8	584.9	582.9	582.3	581.0
G2.0	588.8	588.4	595.9	592.8	597.2	592.4	590.5	585.5
G3.0	594.3	597.1	605.3	605.0	609.1	603.9	601.3	591.6
G4.0	597.7	604.7	612.3	616.3	619.5	615.5	608.2	598.7
G5.0	599.7	611.5	616.9	623.4	624.4	622.9	616.6	603.8
G6.0	601.1	612.2	616.2	628.0	627.8	630.4	626.9	611.3
G7.0	602.5	612.6	614.1	628.3	628.9	636.8	637.7	621.4
G8.0	605.6	611.0	611.5	627.9	631.9	644.6	648.7	632.5
G9.0	606.2	610.3	609.5	627.1	635.2	652.2	657.7	642.9
G10.0	602.7	608.4	608.6	626.5	637.7	654.6	659.7	650.7
G11.0	597.5	604.1	606.4	625.7	638.6	655.4	661.5	652.4
G12.0	589.0	596.3	601.1	622.5	636.8	656.4	662.3	656.0
G13.0	578.7	586.6	594.3	617.8	634.4	660.2	662.3	662.4
G14.0	568.5	579.0	588.5	611.4	633.3	662.1	664.8	669.2
G15.0	558.5	573.3	585.0	606.7	633.7	666.2	669.0	676.5
G16.0	553.2	567.3	586.0	605.5	636.7	673.1	673.8	684.9
G17.0	549.1	564.0	587.8	606.5	638.2	679.2	681.6	697.0
G18.0	548.1	559.7	589.7	610.5	641.2	684.9	685.0	703.4
G19.0	548.1	556.8	592.9	615.8	645.9	689.1	689.9	706.8
G20.0	549.8	560.9	597.1	619.5	654.1	689.7	696.1	710.2
G21.0	552.4	566.8	597.7	623.4	664.2	688.5	705.2	712.1
G22.0	561.9	572.7	592.5	623.6	675.9	692.5	714.3	713.7
G23.0	574.1	572.6	580.4	618.3	681.8	698.4	726.7	717.0
G24.0	580.9	564.1	564.0	607.7	680.1	705.2	737.3	727.0
G25.0	578.2	538.2	541.5	599.2	670.0	713.6	745.3	738.9
G26.0	559.3	505.7	516.5	587.6	660.8	717.3	747.7	746.5
G27.0	524.5	470.9	490.3	573.9	653.3	716.6	747.9	747.5
G28.0	478.6	446.3	481.7	562.8	648.5	713.6	754.4	745.2
G29.0	450.3	440.8	493.4	556.4	640.6	711.5	768.5	745.1
G30.0	438.5	451.8	518.0	547.3	635.4	710.0	789.2	753.0
G31.0	441.0	473.4	564.7	539.0	640.1	716.9	798.7	766.3
G32.0	454.4	516.8	584.2	555.4	639.9	729.2	801.6	778.9
G33.0	478.0	610.9	540.0	571.7	632.4	741.5	802.7	792.9
G34.0	528.2	595.2	443.0	557.3	626.6	746.0	806.8	806.9
G35.0	603.1	396.3	331.4	526.3	629.8	744.2	815.4	816.9
G36.0	596.0	304.9	299.0	518.5	630.2	749.0	818.6	821.7
G37.0	489.9	286.5	287.2	525.0	619.2	764.3	830.6	830.4
G38.0	352.6	269.7	281.8	475.7	614.0	774.0	844.2	851.1
G39.0	294.8	266.2	281.4	344.5	623.2	758.4	836.7	882.7

Test Type : Type C

Test Distance : 8.460 m

C Plane (°): 0.0-360.0:15.0

γ (°): 0.0-90.0:1.0

Test Device : LSG-1890B

Temperature : 25°C

Humidity : 65.0%

Test Lab : LISUN GROUP

Test By : Thomas Fiodorow

Review By :

Light Distribution Data

Unit: cd

G\C	C240.0	C255.0	C270.0	C285.0	C300.0	C315.0	C330.0	C345.0
G40.0	275.2	263.1	279.3	305.2	626.8	732.4	809.2	913.2
G41.0	263.7	261.3	270.5	297.0	611.7	714.6	802.1	921.7
G42.0	254.3	253.4	258.3	292.3	546.0	711.2	834.1	907.5
G43.0	251.0	243.5	232.9	291.4	462.1	714.2	884.0	885.2
G44.0	246.5	231.4	222.2	287.8	412.2	727.2	878.0	862.3
G45.0	241.5	216.1	213.7	270.5	411.0	745.7	842.9	846.3
G46.0	236.8	210.0	216.8	254.2	353.5	736.5	811.7	839.3
G47.0	235.4	210.4	219.4	240.4	322.9	728.3	778.3	846.0
G48.0	227.3	216.9	219.6	233.3	307.6	735.2	748.5	849.4
G49.0	220.0	214.1	230.4	233.2	292.5	683.5	713.7	852.6
G50.0	213.4	210.0	237.9	235.4	286.5	551.7	673.6	842.5
G51.0	214.3	223.9	240.7	236.8	275.8	480.8	654.7	802.9
G52.0	214.9	236.4	262.4	244.4	254.7	445.4	652.0	787.3
G53.0	216.5	245.5	265.7	244.8	247.6	380.6	660.8	789.5
G54.0	231.1	254.0	294.4	246.9	228.8	332.0	649.9	759.4
G55.0	234.1	275.0	321.7	255.6	220.5	289.2	674.9	799.2
G56.0	242.2	319.8	294.4	263.6	228.8	275.6	785.7	851.3
G57.0	263.2	305.2	196.6	297.6	219.8	280.2	730.2	966.4
G58.0	310.7	177.8	153.1	286.6	222.9	265.3	613.8	834.4
G59.0	278.6	153.0	170.7	225.0	236.6	270.9	427.3	783.7
G60.0	178.8	161.3	210.4	215.8	248.8	236.7	350.2	784.0
G61.0	144.4	210.2	149.8	177.9	195.8	214.7	334.8	880.0
G62.0	141.0	169.8	84.3	200.1	162.9	183.5	230.7	849.0
G63.0	195.3	86.7	100.7	147.5	119.2	170.7	240.6	563.5
G64.0	92.1	94.3	95.1	116.8	118.1	126.6	185.1	571.0
G65.0	68.1	135.2	26.3	101.4	110.4	133.7	132.3	349.6
G66.0	73.4	30.3	23.6	81.3	79.1	81.2	95.6	324.2
G67.0	62.0	23.8	23.2	27.1	56.8	49.7	55.6	228.6
G68.0	20.6	23.3	20.6	22.6	35.0	51.9	39.2	188.9
G69.0	18.4	21.1	15.3	21.0	16.6	22.6	31.4	188.5
G70.0	16.5	16.8	9.6	18.5	14.4	18.1	25.7	169.5
G71.0	14.0	8.9	6.2	12.4	12.0	15.6	20.2	109.6
G72.0	9.4	6.4	5.5	6.9	9.7	12.5	13.7	64.4
G73.0	6.8	5.6	5.0	6.1	6.4	8.3	11.9	36.6
G74.0	6.4	5.0	4.7	5.6	5.4	7.2	10.5	24.9
G75.0	6.0	4.6	4.5	5.0	5.1	7.7	9.5	19.8
G76.0	5.3	4.3	4.1	4.8	4.8	7.3	8.9	17.6
G77.0	5.0	4.0	3.9	4.6	4.6	7.1	8.5	16.9
G78.0	4.8	3.9	3.8	4.5	4.6	6.7	9.0	16.9
G79.0	4.5	3.7	3.6	4.3	4.7	8.0	9.2	16.9

Test Type : Type C

Test Distance : 8.460 m

C Plane (°): 0.0-360.0:15.0

γ (°): 0.0-90.0:1.0

Test Device : LSG-1890B

Temperature : 25°C

Humidity : 65.0%

Test Lab : LISUN GROUP

Test By : Thomas Fiodorow

Review By :

Report No. : LISUN-001

Test Time : 2023-01-03 14:12:36

Page 22 of 22

Light Distribution Data

Unit: cd

G\C	C240.0	C255.0	C270.0	C285.0	C300.0	C315.0	C330.0	C345.0
G80.0	4.1	3.7	3.3	3.9	4.7	7.8	9.0	15.9
G81.0	3.9	3.2	2.9	3.5	5.0	7.5	9.5	16.0
G82.0	3.9	3.0	2.7	3.2	5.4	7.0	12.2	16.9
G83.0	3.7	2.7	2.3	2.8	5.5	6.3	16.0	16.2
G84.0	3.5	2.6	2.1	2.7	5.8	6.2	14.7	15.5
G85.0	3.4	2.4	1.9	2.6	5.7	6.0	14.7	17.7
G86.0	3.2	2.2	1.7	2.5	5.4	5.4	18.0	16.6
G87.0	3.3	2.2	1.4	2.6	5.4	5.2	20.4	17.3
G88.0	3.1	2.0	1.3	2.5	5.4	5.0	17.2	16.2
G89.0	2.8	1.9	1.3	2.3	4.7	4.5	15.1	17.0
G90.0	2.6	1.7	1.2	2.2	4.8	4.1	15.8	14.2

Test Type : Type C

Test Distance : 8.460 m

C Plane (°): 0.0-360.0:15.0

γ (°): 0.0-90.0:1.0

Test Device : LSG-1890B

Temperature : 25°C

Humidity : 65.0%

Test Lab : LISUN GROUP

Test By : Thomas Fiodorow

Review By :

Report No. : LISUN-002

Test Time : 2023-01-03 15:40:15

Page 1 of 22

Lisun Goniophotometer Test Report

Product Info

Luminaire Category : **Indoor**
 Luminaire : **ID-AC297**
 Lamp Category : **CREE**
 Lamp : **011507**
 Manufacturer : **Philips Lighting B.V.**
 Submitter : **Michael Aslami**
 Number of Lamps : **1** Lumens per Lamp : **3300 lm**
 Luminous Length : **595 mm** Luminous Width : **595 mm** Luminous Height : **0 mm**

Electric Parameters

Voltage : **230.00 V** Current : **0.2089 A** Power : **46.95 W** Power Factor : **0.978** Frequency : **50.00 Hz**

Photometric Parameters

CIE Class : Direct Measurement Flux : 3124.1 lm Upward Ratio : 0.00 % Maximum Intensity : 1083.51 cd Central Intensity : 1083.42 cd Luminaire Efficacy Rating (LER) : 67 Beam Angle (C0-C180,C90-C270) : 113.5 °, 110.5 ° Field Angle (C0-C180,C90-C270) : 165.2 °, 164.4 °	Total Rated Lamp Lumens : 3300.0 lm Efficiency : 94.67 % Downward Ratio : 94.67 % Position Of Maximum Intensity : C90° γ1° S/MH(C0-C180,C90-C270) : 1.26, 1.24 Energy Efficiency Class : G (EU 2019/2015 η_{TM}:67lm/W) Beam Angle (C45-C225,C135-C315) : 111.9 °, 111.9 ° Field Angle (C45-C225,C135-C315) : 164.8 °, 164.8 °
--	---

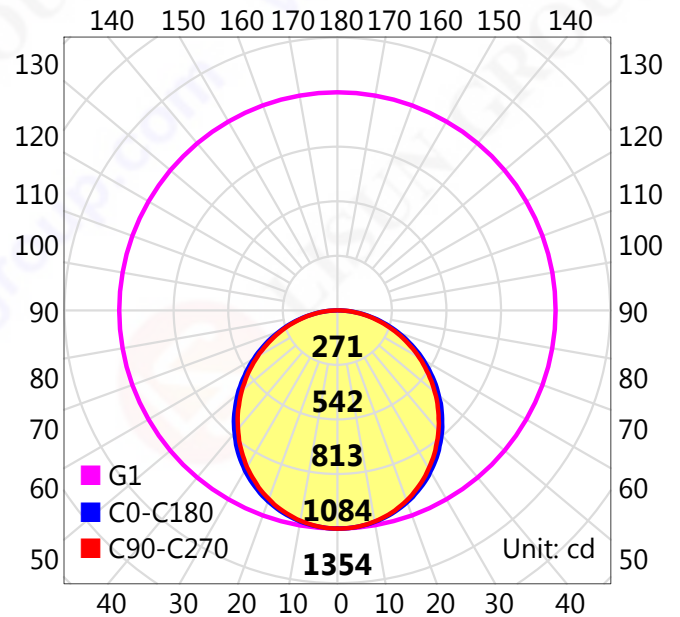
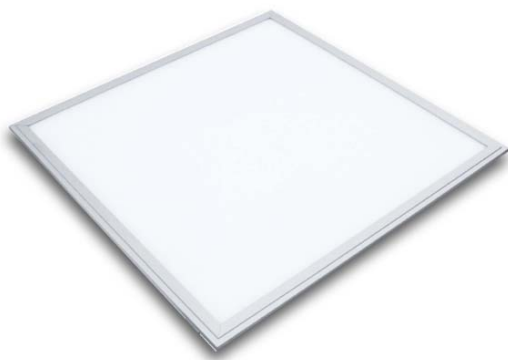

Test Type : Type C Test Distance : 8.460 m
 Test Device : LSG-1890B
 Test Lab : LISUN GROUP
 Test By : Thomas Fiodorow

C Plane (°): 0.0-360.0:22.5 γ (°): 0.0-90.0:1.0
 Temperature : 25°C Humidity : 65.0%
 Review By :

Light Distribution Curve

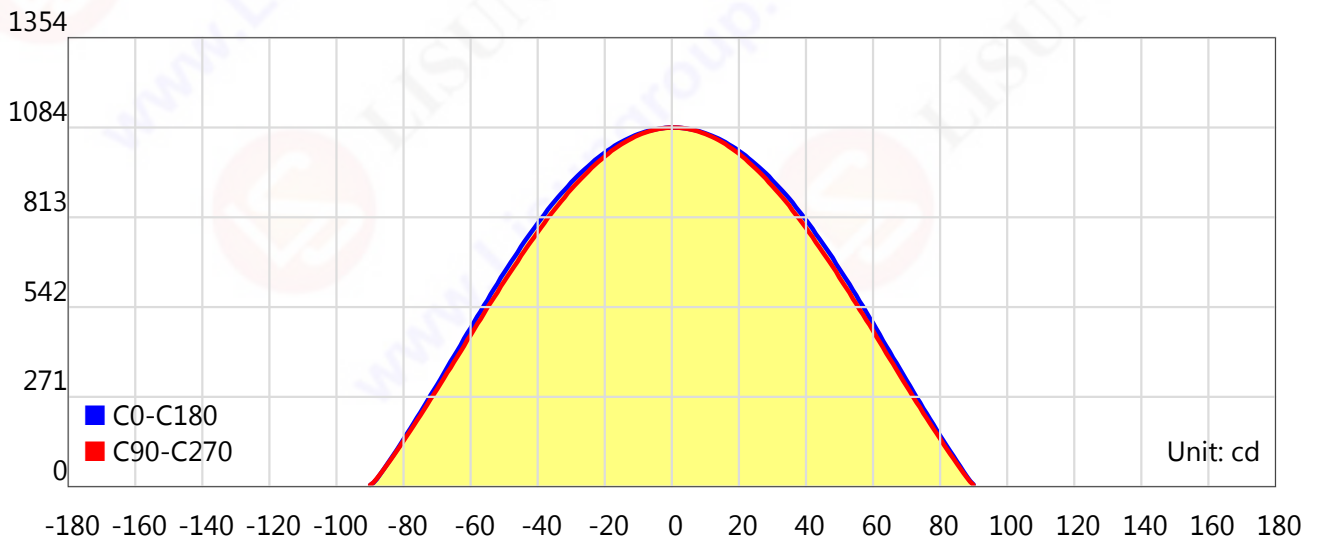
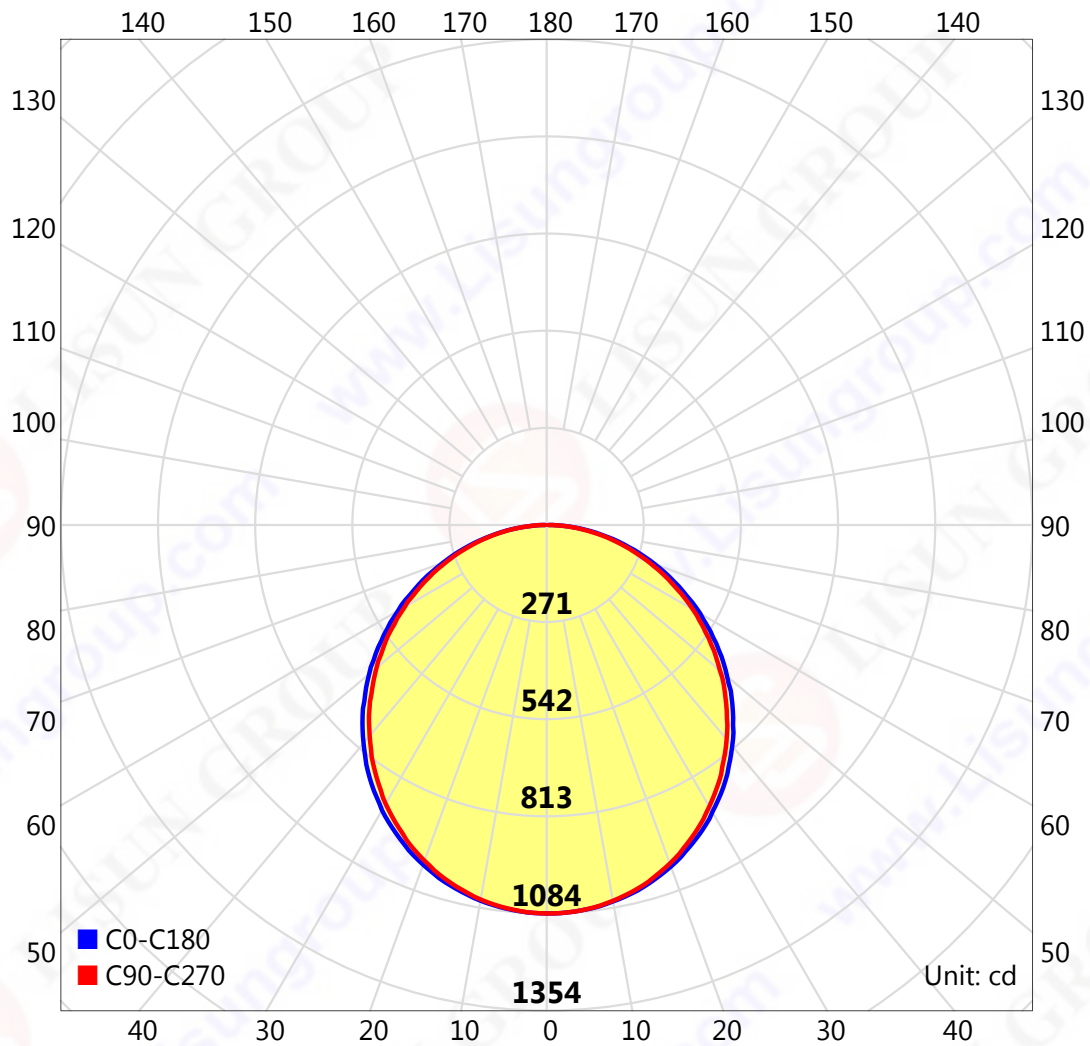

Light Distribution Curve (cd/klm)

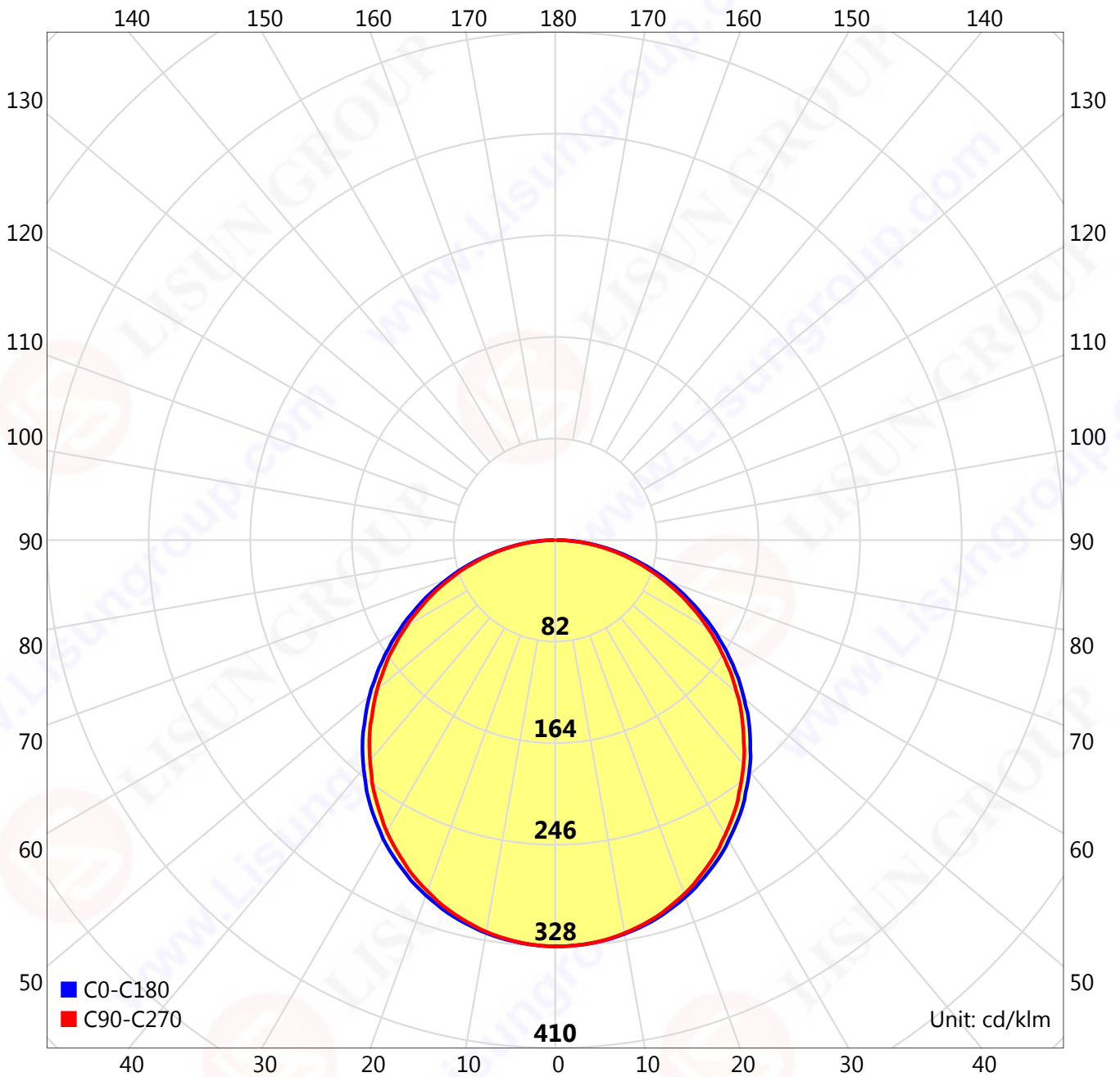

011507/CREE

$\eta=94.67\%$

Warmup Log

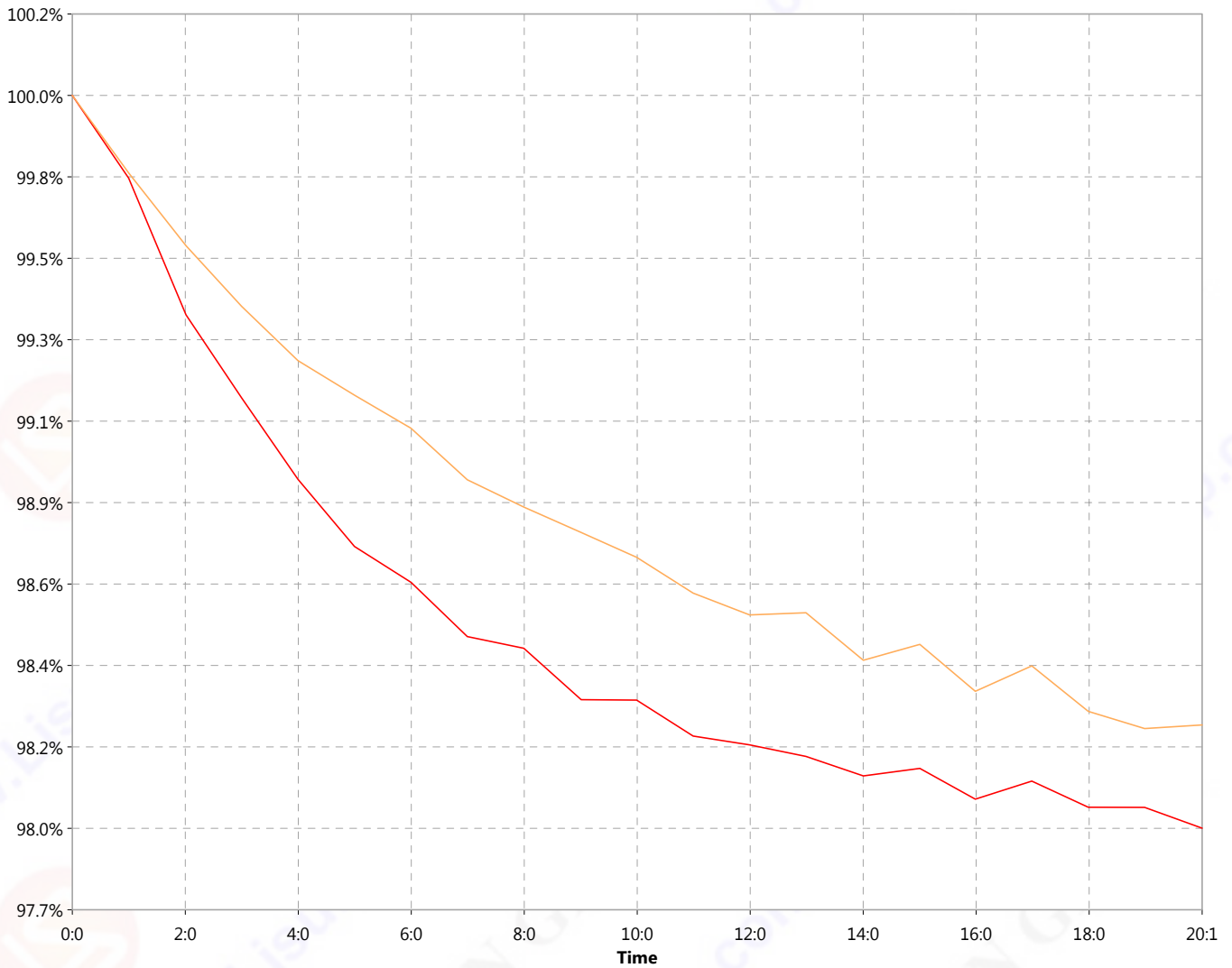

Stable time: 20:1

Uptime: 0:0

Parameters	Maximum	Minimum	Change
Luminous intensity ,cd	1104.33	1081.91	22.41
Power ,W	47.83	47.00	0.84

UGR

Reflectance										
Ceiling (cavity)	0.7	0.7	0.5	0.5	0.3	0.7	0.7	0.5	0.5	0.3
Wall	0.5	0.3	0.5	0.3	0.3	0.5	0.3	0.5	0.3	0.3
Reference plane	0.2	0.2	0.2	0.2	0.2	0.2	0.2	0.2	0.2	0.2
Room dimensions	Viewed crosswise					Viewed endwise				
X=2H Y=2H	15.8	17.4	16.1	17.7	18.0	15.4	17.1	15.8	17.4	17.7
3H	17.7	19.2	18.1	19.5	19.9	17.4	18.9	17.7	19.2	19.5
4H	18.5	19.9	18.9	20.2	20.6	18.1	19.5	18.5	19.9	20.3
6H	19.1	20.4	19.5	20.8	21.2	18.7	20.1	19.2	20.4	20.8
8H	19.4	20.6	19.8	21.0	21.4	19.0	20.2	19.4	20.6	21.0
12H	19.6	20.8	20.0	21.1	21.6	19.1	20.3	19.6	20.7	21.2
X=4H Y=2H	16.4	17.8	16.8	18.1	18.5	16.2	17.6	16.6	17.9	18.3
3H	18.6	19.8	19.0	20.1	20.5	18.3	19.5	18.7	19.9	20.3
4H	19.5	20.6	19.9	21.0	21.4	19.2	20.3	19.6	20.7	21.1
6H	20.3	21.2	20.7	21.7	22.1	19.9	20.9	20.4	21.3	21.8
8H	20.6	21.5	21.0	21.9	22.4	20.2	21.1	20.7	21.5	22.0
12H	20.8	21.6	21.3	22.1	22.6	20.4	21.2	20.9	21.7	22.2
X=8H Y=4H	19.8	20.7	20.3	21.2	21.6	19.6	20.4	20.0	20.9	21.4
6H	20.7	21.5	21.3	22.0	22.5	20.4	21.2	20.9	21.7	22.2
8H	21.2	21.8	21.7	22.3	22.8	20.8	21.5	21.3	22.0	22.5
12H	21.5	22.1	22.0	22.6	23.1	21.1	21.7	21.6	22.2	22.8
X=12H Y=4H	19.9	20.7	20.4	21.2	21.6	19.6	20.4	20.1	20.9	21.4
6H	20.9	21.5	21.4	22.0	22.5	20.6	21.2	21.1	21.7	22.2
8H	21.3	21.9	21.8	22.4	22.9	21.0	21.6	21.5	22.1	22.6

Calculate in accordance with CIE 190:2010. The table is corrected with 3300lm ($8\log(F/F_0) = 4.1$).

Reflectance										
Ceiling (cavity)	0.7	0.7	0.5	0.5	0.3	0.7	0.7	0.5	0.5	0.3
Wall	0.5	0.3	0.5	0.3	0.3	0.5	0.3	0.5	0.3	0.3
Reference plane	0.2	0.2	0.2	0.2	0.2	0.2	0.2	0.2	0.2	0.2
Room dimensions	Viewed crosswise					Viewed endwise				
X=2H Y=2H	16.2	17.6	16.5	17.9	18.1	16.0	17.4	16.3	17.6	17.9
3H	17.9	19.2	18.2	19.5	19.8	17.6	18.9	18.0	19.2	19.5
4H	18.6	19.9	19.0	20.2	20.5	18.3	19.5	18.7	19.8	20.1
6H	19.2	20.4	19.6	20.7	21.0	18.9	20.0	19.3	20.3	20.7
8H	19.5	20.6	19.8	20.9	21.2	19.1	20.2	19.5	20.5	20.8
12H	19.6	20.7	20.0	21.0	21.4	19.2	20.3	19.6	20.6	21.0
X=4H Y=2H	16.9	18.1	17.2	18.4	18.7	16.7	17.9	17.1	18.2	18.5
3H	18.8	19.8	19.2	20.2	20.5	18.5	19.6	18.9	19.9	20.3
4H	19.7	20.6	20.1	21.0	21.3	19.4	20.3	19.8	20.7	21.1
6H	20.4	21.2	20.8	21.6	22.0	20.1	20.9	20.5	21.3	21.7
8H	20.7	21.5	21.1	21.9	22.3	20.4	21.1	20.8	21.5	22.0
12H	20.9	21.6	21.4	22.0	22.5	20.6	21.3	21.0	21.7	22.1
X=8H Y=4H	20.0	20.8	20.4	21.2	21.6	19.8	20.5	20.2	20.9	21.3
6H	20.9	21.5	21.4	22.0	22.4	20.6	21.3	21.1	21.7	22.2
8H	21.3	21.8	21.8	22.3	22.8	21.0	21.6	21.5	22.0	22.5
12H	21.6	22.1	22.1	22.6	23.1	21.3	21.8	21.8	22.3	22.8
X=12H Y=4H	20.0	20.7	20.5	21.1	21.6	19.8	20.5	20.3	20.9	21.4
6H	21.0	21.5	21.5	22.0	22.5	20.7	21.3	21.2	21.7	22.2
8H	21.4	21.9	21.9	22.4	22.9	21.1	21.6	21.6	22.1	22.6
Variations with the observer position at spacings										
S=1.0H						+0.2/-0.2				
S=1.5H						+0.4/-0.4				
S=2.0H						+0.5/-0.7				

Calculate in accordance with CIE Pub.117. The table is corrected with 3300lm ($8\log(F/F_0) = 4.1$).

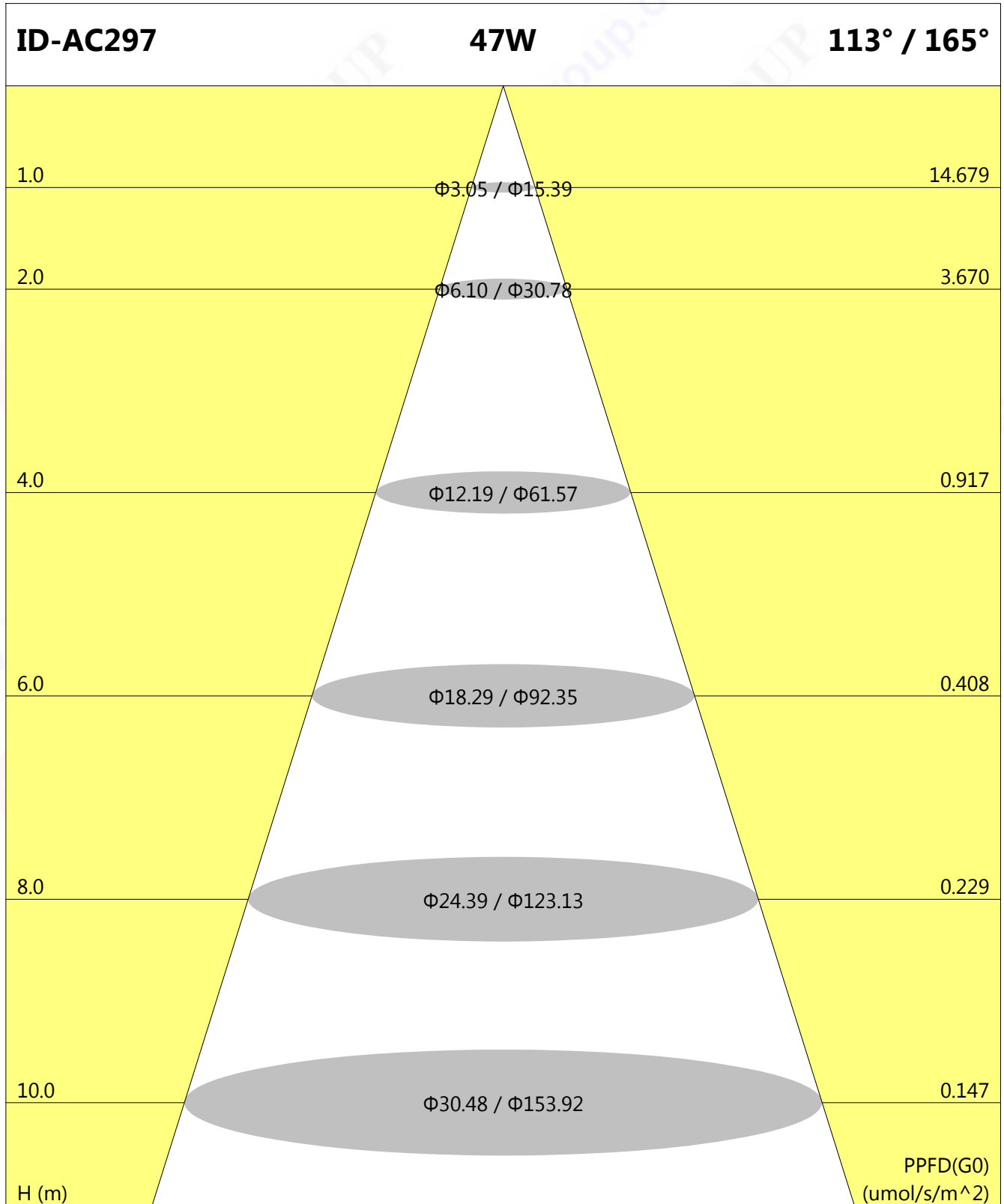
PPFD-Distance

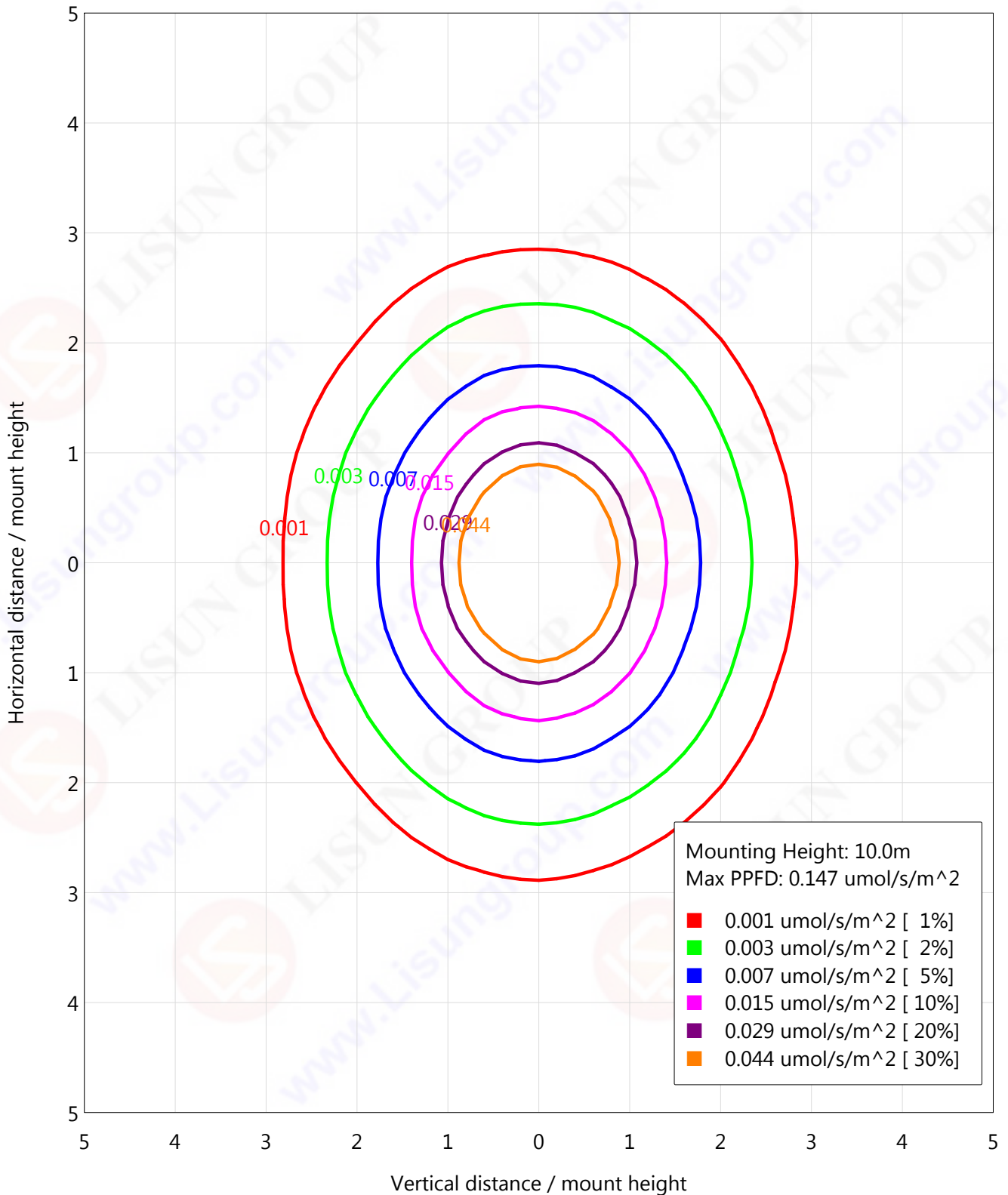
IsoPPFD

IsoCandela

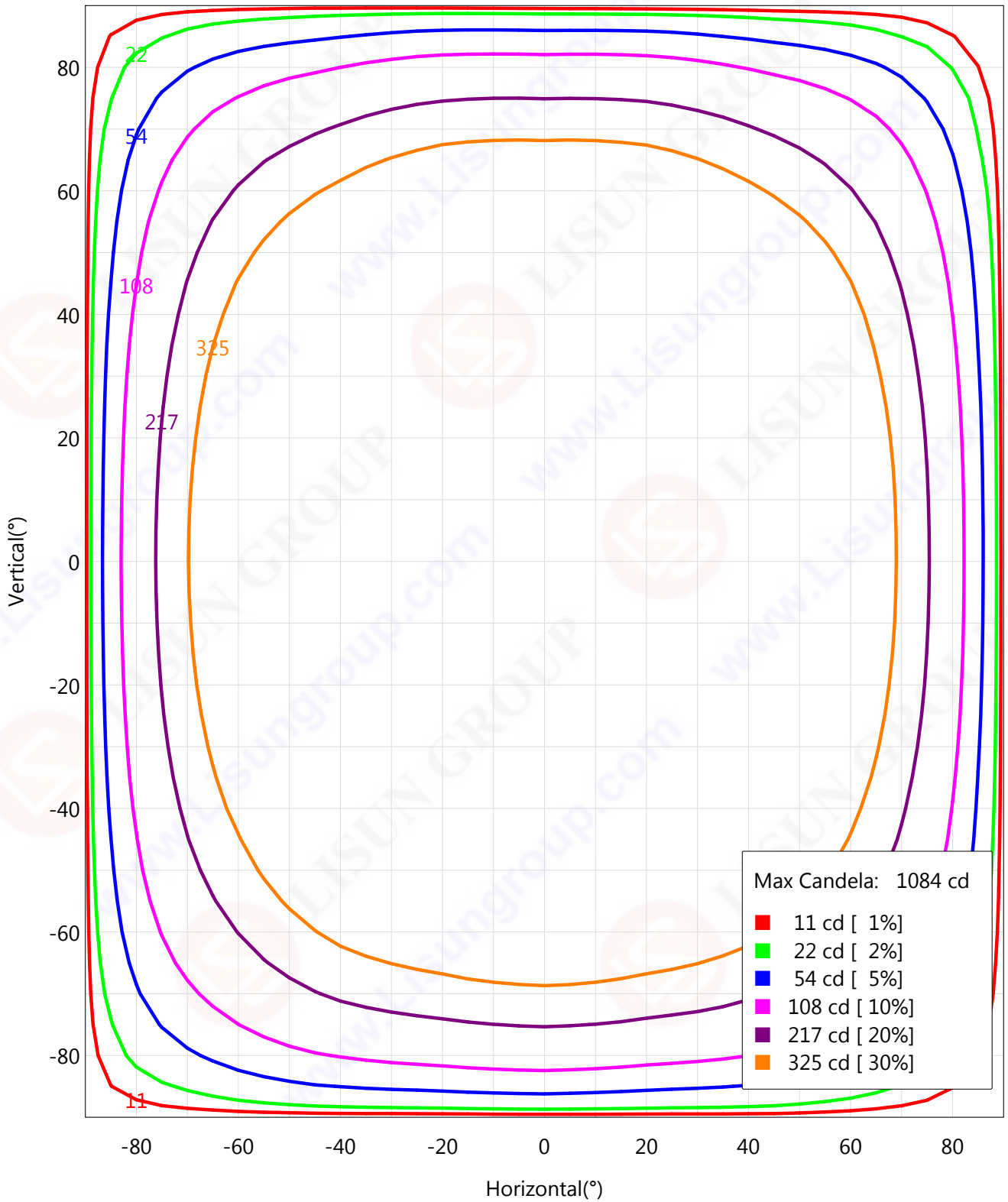

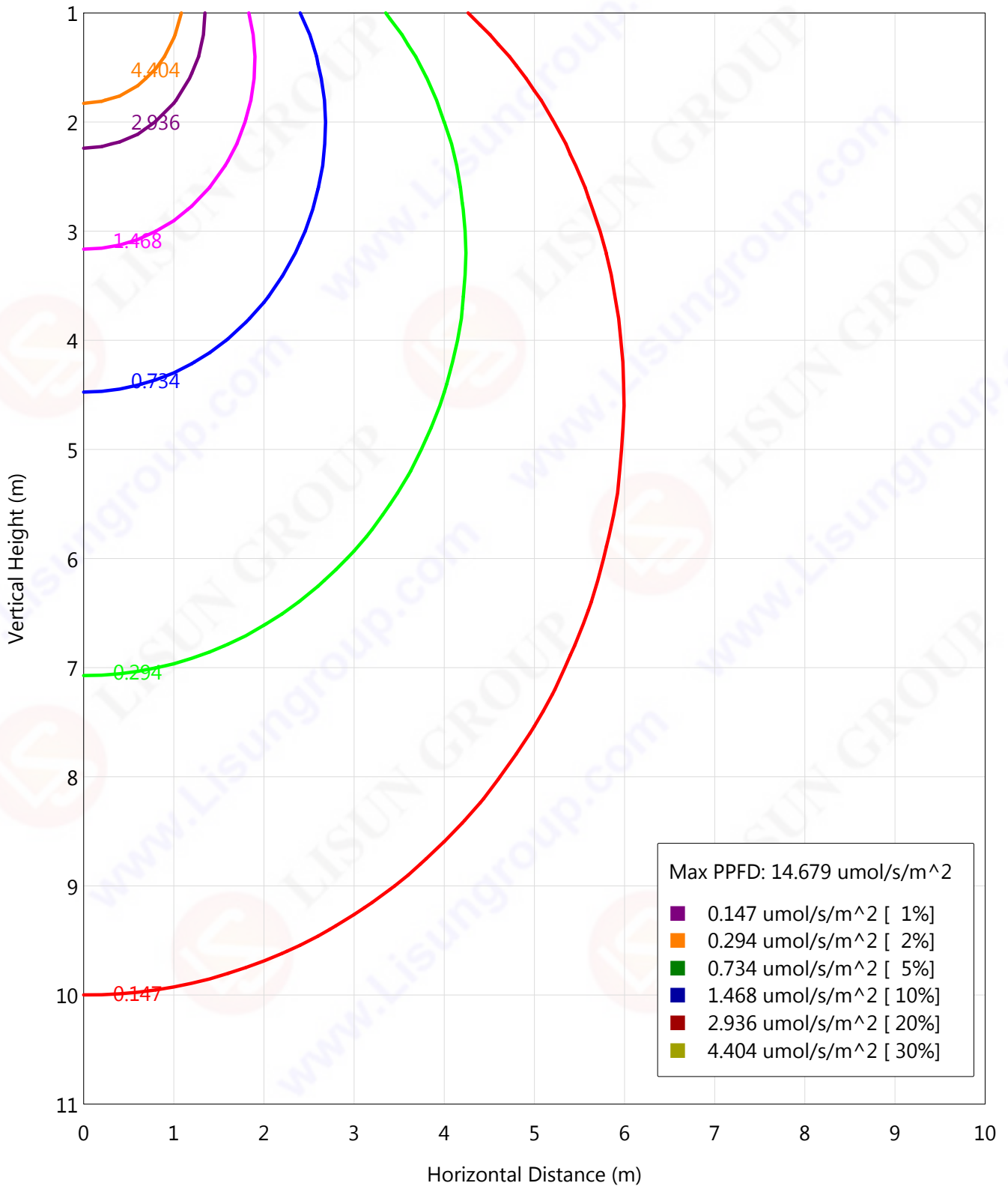
Vertical IsoPPFD Plot

Average PPFD Effective Figure

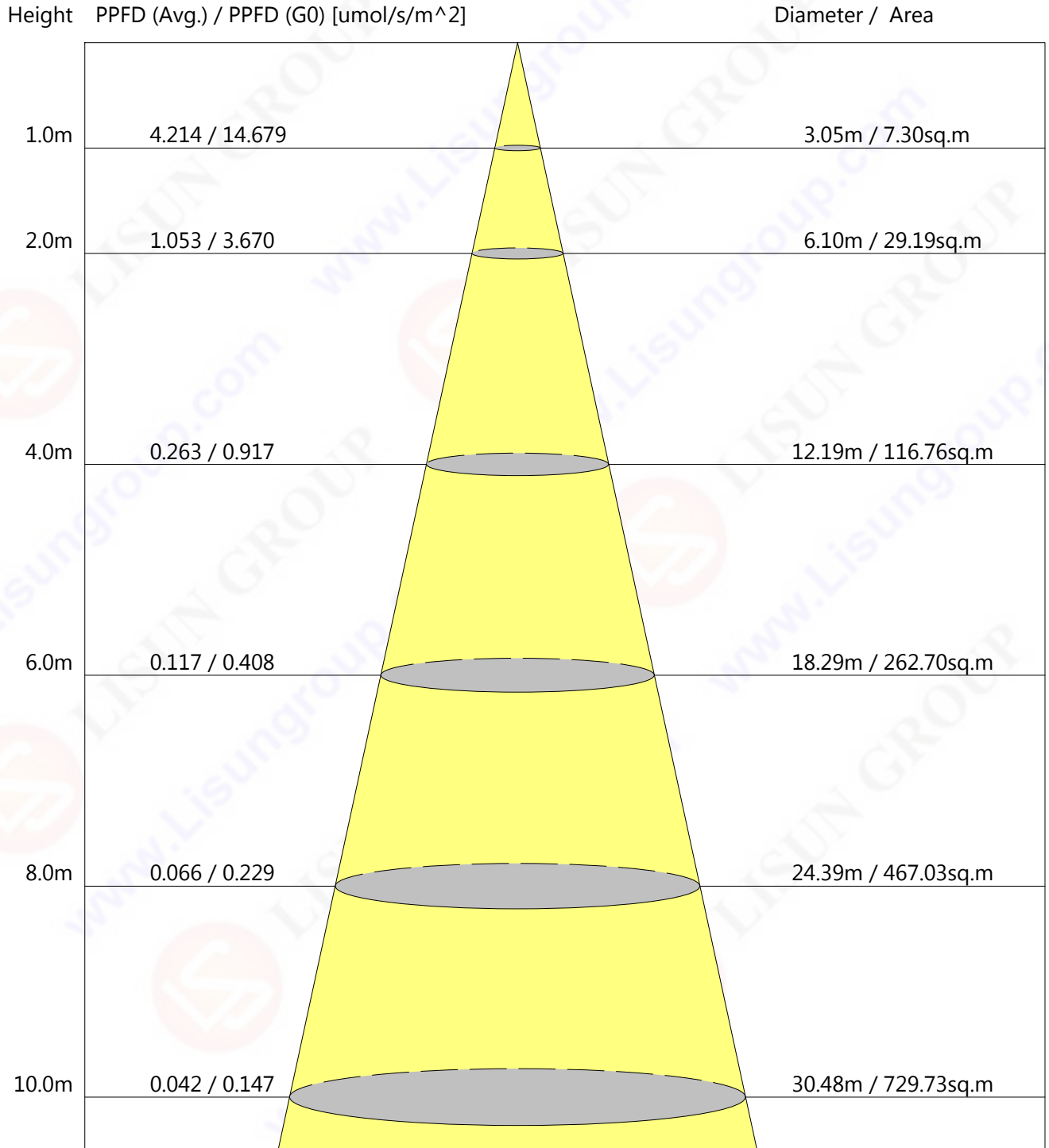

Beam Angle: 113.5° PPF Out: 30.751 $\mu\text{mol/s}$

Lumen Limit Curve

L (cd/m ²)	G45	G50	G55	G60	G65	G70	G75	G80	G85
C0	2932	2887	2845	2792	2724	2655	2580	2512	2495
C90	2829	2772	2719	2658	2583	2508	2424	2361	2271
C270	2894	2841	2770	2703	2632	2539	2445	2326	2162
C90	2785	2724	2665	2583	2517	2432	2348	2249	2128

Dazzle	Quality	Illuminance (lx)							
1.15	A	2000	1000	500	<=300				
1.50	B		2000	1000	500	<=300			
1.85	C			2000	1000	500	<=300		
2.20	D				2000	1000	500	<=300	
2.55	E					2000	1000	500	<=300

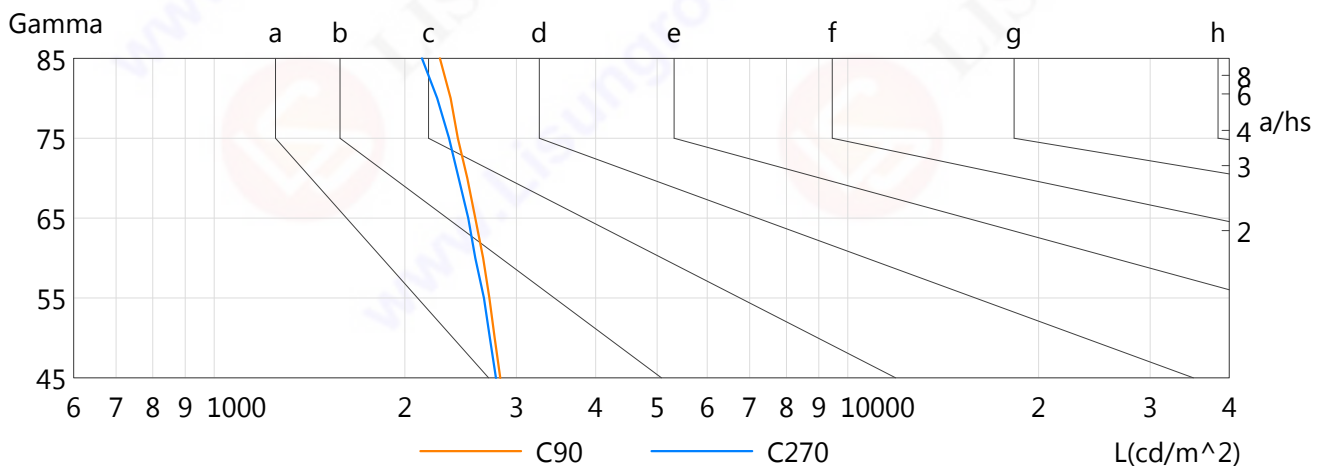
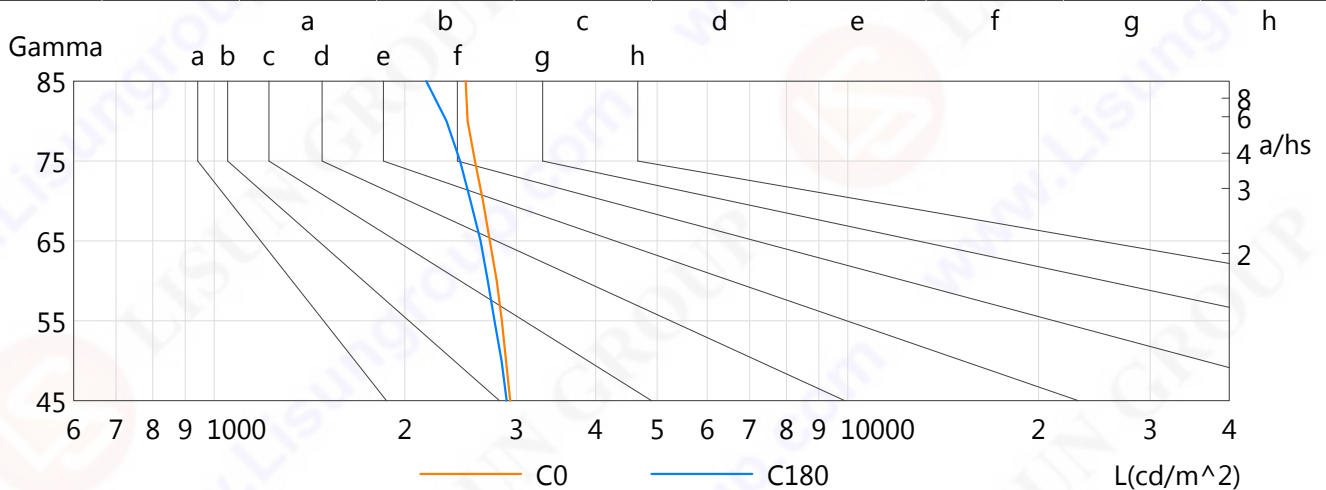

Test Type : Type C

Test Distance : 8.460 m

C Plane (°): 0.0-360.0:22.5

γ (°): 0.0-90.0:1.0

Test Device : LSG-1890B

Temperature : 25°C

Humidity : 65.0%

Test Lab : LISUN GROUP

Test By : Thomas Fiodorow

Review By :

TM5 UF Table

Utilisation Factors UF (F)			SHR NOM = 1.25								
Room Reflectance			Room Index(RI)								
C	W	F	0.75	1.00	1.25	1.50	2.00	2.50	3.00	4.00	5.00
0.70	0.50	0.20	0.53	0.63	0.70	0.75	0.82	0.87	0.90	0.94	0.97
	0.30		0.45	0.55	0.63	0.68	0.76	0.81	0.85	0.90	0.94
	0.20		0.40	0.50	0.57	0.63	0.71	0.77	0.81	0.87	0.91
0.50	0.50	0.20	0.51	0.61	0.67	0.72	0.79	0.83	0.86	0.91	0.93
	0.30		0.45	0.54	0.61	0.66	0.74	0.79	0.82	0.87	0.90
	0.20		0.40	0.49	0.56	0.62	0.69	0.75	0.79	0.84	0.88
0.30	0.50	0.20	0.50	0.59	0.65	0.70	0.76	0.80	0.83	0.87	0.90
	0.30		0.44	0.53	0.60	0.65	0.72	0.76	0.80	0.84	0.87
	0.20		0.39	0.49	0.55	0.61	0.68	0.73	0.77	0.82	0.85
0.00	0.00	0.00	0.37	0.46	0.53	0.58	0.65	0.69	0.73	0.78	0.81
Utilisation Factors UF (W)			SHR NOM = 1.25								
Room Reflectance			Room Index(RI)								
C	W	F	0.75	1.00	1.25	1.50	2.00	2.50	3.00	4.00	5.00
0.70	0.50	0.20	0.96	0.79	0.68	0.59	0.48	0.40	0.34	0.26	0.22
	0.30		0.80	0.68	0.59	0.52	0.43	0.36	0.31	0.25	0.21
	0.20		0.69	0.59	0.52	0.47	0.39	0.34	0.29	0.23	0.20
0.50	0.50	0.20	0.93	0.76	0.65	0.57	0.46	0.41	0.32	0.25	0.21
	0.30		0.78	0.66	0.58	0.51	0.42	0.35	0.30	0.24	0.20
	0.20		0.68	0.59	0.52	0.46	0.38	0.33	0.28	0.23	0.19
0.30	0.50	0.20	0.90	0.74	0.63	0.55	0.44	0.36	0.31	0.24	0.20
	0.30		0.77	0.65	0.56	0.49	0.40	0.34	0.29	0.23	0.19
	0.20		0.67	0.58	0.51	0.45	0.37	0.32	0.28	0.22	0.18
0.00	0.00	0.00	0.58	0.49	0.42	0.37	0.30	0.25	0.22	0.17	0.14
Utilisation Factors UF (C)			SHR NOM = 1.25								
Room Reflectance			Room Index(RI)								
C	W	F	0.75	1.00	1.25	1.50	2.00	2.50	3.00	4.00	5.00
0.70	0.50	0.20	0.16	0.17	0.18	0.18	0.19	0.20	0.20	0.20	0.21
	0.30		0.09	0.11	0.12	0.13	0.14	0.15	0.16	0.17	0.18
	0.20		0.04	0.06	0.07	0.08	0.10	0.12	0.13	0.15	0.16
0.50	0.50	0.20	0.15	0.16	0.17	0.18	0.18	0.19	0.19	0.20	0.20
	0.30		0.09	0.10	0.11	0.12	0.14	0.15	0.16	0.17	0.18
	0.20		0.04	0.06	0.07	0.08	0.10	0.12	0.13	0.14	0.15
0.30	0.50	0.20	0.15	0.16	0.16	0.17	0.18	0.18	0.18	0.19	0.19
	0.30		0.09	0.10	0.11	0.12	0.13	0.14	0.15	0.16	0.17
	0.20		0.04	0.06	0.07	0.08	0.10	0.11	0.12	0.14	0.15
0.00	0.00	0.00	NA	NA	NA	NA	NA	NA	NA	NA	NA

Rating: 47W Photometrically tested without ceiling board.

Multiply UF values by service correction factors

Calculate in accordance with CIBSE Technical Memorandum No.5/1980

Indoor CU, Curves of Luminaires vs Lighting Area

RC	0.8	0.8	0.8	0.8	0.7	0.7	0.7	0.7	0.5	0.5	0.5	0.3	0.3	0.3	0.1	0.1	0.1	0
RW	0.7	0.5	0.3	0.1	0.7	0.5	0.3	0.1	0.5	0.3	0.1	0.5	0.3	0.1	0.5	0.3	0.1	0
RCR	RF = 0.2																	
0	113	113	113	113	110	110	110	110	105	105	105	101	101	101	97	97	97	95
1	103	98	94	90	100	96	92	88	92	89	86	88	85	83	85	82	81	79
2	93	85	78	73	91	83	77	72	80	75	70	77	72	69	74	70	67	65
3	85	75	67	60	82	73	66	60	70	64	59	68	62	58	65	61	57	55
4	78	66	58	51	75	65	57	51	62	55	50	60	54	49	58	53	49	47
5	71	59	50	44	69	58	50	44	56	49	43	54	48	43	52	47	42	40
6	66	53	44	38	64	52	44	38	50	43	38	49	42	37	47	42	37	35
7	61	48	40	34	59	47	39	34	46	39	33	44	38	33	43	37	33	31
8	57	44	36	30	55	43	35	30	42	35	30	41	34	30	40	34	29	28
9	53	40	32	27	52	40	32	27	39	32	27	38	31	27	37	31	27	25
10	50	37	30	25	49	37	29	24	36	29	24	35	29	24	34	28	24	22

Spacing Criteria: 1.26 (0-180), 1.24 (90-270), 1.37 (Diagonal)

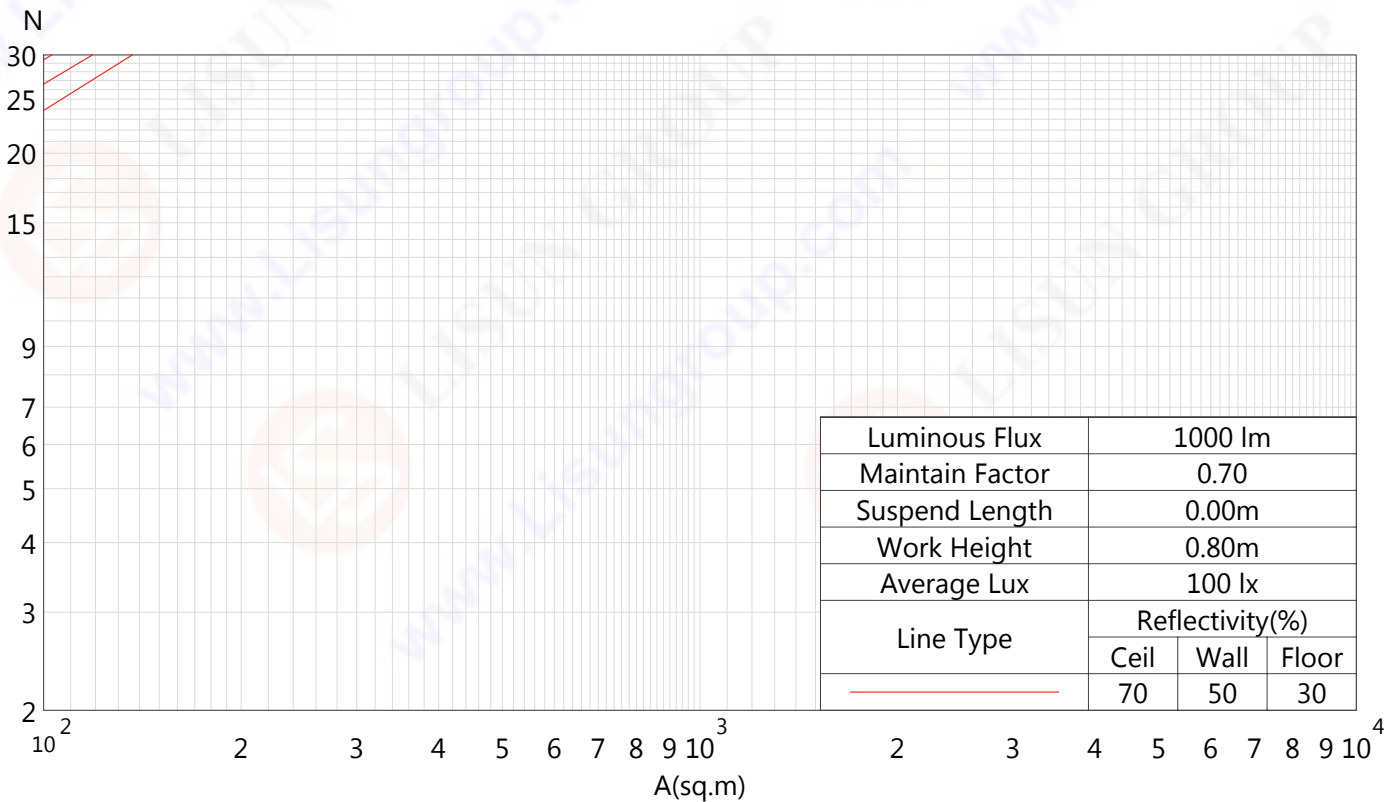

Test Type : Type C

Test Distance : 8.460 m

C Plane (°): 0.0-360.0:22.5

γ (°): 0.0-90.0:1.0

Test Device : LSG-1890B

Temperature : 25°C

Humidity : 65.0%

Test Lab : LISUN GROUP

Test By : Thomas Fiodorow

Review By :

Zonal Flux

Gamma °	Imean cd	Zonal Flux lm	Sum Zonal Flux lm	Rel Zonal Flux %	Sum Rel Zonal Flux %
0.0-1.0	1083.3	1.0	1.0	0.03	0.03
1.0-2.0	1082.9	3.1	4.1	0.09	0.13
2.0-3.0	1082.1	5.2	9.3	0.16	0.28
3.0-4.0	1080.9	7.2	16.6	0.22	0.50
4.0-5.0	1079.3	9.3	25.8	0.28	0.78
5.0-6.0	1077.3	11.3	37.2	0.34	1.13
6.0-7.0	1075.0	13.3	50.5	0.40	1.53
7.0-8.0	1072.3	15.3	65.9	0.47	2.00
8.0-9.0	1069.2	17.3	83.2	0.53	2.52
9.0-10.0	1065.6	19.3	102.5	0.58	3.11
10.0-11.0	1061.7	21.2	123.7	0.64	3.75
11.0-12.0	1057.3	23.1	146.8	0.70	4.45
12.0-13.0	1052.6	25.0	171.8	0.76	5.21
13.0-14.0	1047.6	26.8	198.6	0.81	6.02
14.0-15.0	1042.3	28.6	227.2	0.87	6.89
15.0-16.0	1036.4	30.4	257.6	0.92	7.81
16.0-17.0	1030.2	32.1	289.7	0.97	8.78
17.0-18.0	1023.5	33.8	323.4	1.02	9.80
18.0-19.0	1016.6	35.4	358.8	1.07	10.87
19.0-20.0	1009.3	36.9	395.8	1.12	11.99
20.0-21.0	1001.7	38.5	434.2	1.17	13.16
21.0-22.0	993.8	39.9	474.2	1.21	14.37
22.0-23.0	985.4	41.4	515.5	1.25	15.62
23.0-24.0	976.5	42.7	558.2	1.29	16.92
24.0-25.0	967.3	44.0	602.2	1.33	18.25
25.0-26.0	957.9	45.2	647.4	1.37	19.62
26.0-27.0	948.3	46.4	693.8	1.41	21.03
27.0-28.0	938.5	47.5	741.4	1.44	22.47
28.0-29.0	928.2	48.6	789.9	1.47	23.94
29.0-30.0	917.4	49.5	839.5	1.50	25.44
30.0-31.0	906.1	50.4	889.9	1.53	26.97
31.0-32.0	894.5	51.3	941.1	1.55	28.52
32.0-33.0	883.0	52.0	993.2	1.58	30.10
33.0-34.0	871.4	52.7	1045.9	1.60	31.69
34.0-35.0	859.3	53.4	1099.3	1.62	33.31
35.0-36.0	846.8	53.9	1153.2	1.63	34.95
36.0-37.0	833.9	54.4	1207.6	1.65	36.59
37.0-38.0	820.6	54.8	1262.4	1.66	38.25
38.0-39.0	807.2	55.1	1317.5	1.67	39.92
39.0-40.0	793.8	55.4	1372.9	1.68	41.60

Test Type : Type C

Test Distance : 8.460 m

C Plane (°): 0.0-360.0:22.5

γ (°): 0.0-90.0:1.0

Test Device : LSG-1890B

Temperature : 25°C

Humidity : 65.0%

Test Lab : LISUN GROUP

Test By : Thomas Fiodorow

Review By :

Report No. : LISUN-002

Test Time : 2023-01-03 15:40:15

Page 15 of 22

Zonal Flux

Gamma °	I _{mean} cd	Zonal Flux lm	Sum Zonal Flux lm	Rel Zonal Flux %	Sum Rel Zonal Flux %
40.0-41.0	779.9	55.5	1428.4	1.68	43.28
41.0-42.0	766.1	55.7	1484.1	1.69	44.97
42.0-43.0	751.8	55.7	1539.8	1.69	46.66
43.0-44.0	737.3	55.7	1595.4	1.69	48.35
44.0-45.0	722.6	55.5	1651.0	1.68	50.03
45.0-46.0	707.4	55.3	1706.3	1.68	51.71
46.0-47.0	692.3	55.1	1761.3	1.67	53.37
47.0-48.0	677.3	54.8	1816.1	1.66	55.03
48.0-49.0	661.9	54.4	1870.5	1.65	56.68
49.0-50.0	646.2	53.9	1924.4	1.63	58.31
50.0-51.0	630.3	53.3	1977.7	1.62	59.93
51.0-52.0	614.3	52.7	2030.4	1.60	61.53
52.0-53.0	598.4	52.1	2082.5	1.58	63.11
53.0-54.0	582.2	51.3	2133.8	1.56	64.66
54.0-55.0	565.8	50.5	2184.3	1.53	66.19
55.0-56.0	549.3	49.6	2233.9	1.50	67.70
56.0-57.0	532.7	48.7	2282.7	1.48	69.17
57.0-58.0	516.2	47.7	2330.4	1.45	70.62
58.0-59.0	499.7	46.7	2377.1	1.42	72.03
59.0-60.0	483.0	45.6	2422.8	1.38	73.42
60.0-61.0	466.3	44.5	2467.3	1.35	74.77
61.0-62.0	449.5	43.3	2510.6	1.31	76.08
62.0-63.0	432.7	42.1	2552.7	1.28	77.35
63.0-64.0	415.8	40.8	2593.5	1.24	78.59
64.0-65.0	399.1	39.5	2633.0	1.20	79.79
65.0-66.0	382.4	38.2	2671.1	1.16	80.94
66.0-67.0	365.5	36.8	2707.9	1.11	82.06
67.0-68.0	348.8	35.3	2743.2	1.07	83.13
68.0-69.0	331.9	33.9	2777.1	1.03	84.15
69.0-70.0	315.1	32.4	2809.5	0.98	85.14
70.0-71.0	298.6	30.9	2840.3	0.94	86.07
71.0-72.0	282.1	29.3	2869.7	0.89	86.96
72.0-73.0	265.4	27.8	2897.4	0.84	87.80
73.0-74.0	249.1	26.2	2923.6	0.79	88.59
74.0-75.0	232.7	24.6	2948.2	0.75	89.34
75.0-76.0	216.6	23.0	2971.2	0.70	90.04
76.0-77.0	200.6	21.4	2992.6	0.65	90.68
77.0-78.0	184.6	19.8	3012.4	0.60	91.28
78.0-79.0	168.8	18.1	3030.5	0.55	91.83
79.0-80.0	153.1	16.5	3047.0	0.50	92.33

Test Type : Type C

Test Distance : 8.460 m

C Plane (°): 0.0-360.0:22.5

γ (°): 0.0-90.0:1.0

Test Device : LSG-1890B

Temperature : 25°C

Humidity : 65.0%

Test Lab : LISUN GROUP

Test By : Thomas Fiodorow

Review By :

Zonal Flux

Gamma °	I _{mean} cd	Zonal Flux lm	Sum Zonal Flux lm	Rel Zonal Flux %	Sum Rel Zonal Flux %
80.0-81.0	137.5	14.9	3061.9	0.45	92.78
81.0-82.0	122.1	13.2	3075.1	0.40	93.19
82.0-83.0	106.8	11.6	3086.7	0.35	93.54
83.0-84.0	91.8	10.0	3096.7	0.30	93.84
84.0-85.0	77.0	8.4	3105.1	0.25	94.10
85.0-86.0	62.3	6.8	3112.0	0.21	94.30
86.0-87.0	47.8	5.2	3117.2	0.16	94.46
87.0-88.0	33.5	3.7	3120.9	0.11	94.57
88.0-89.0	20.2	2.2	3123.1	0.07	94.64
89.0-90.0	9.6	1.0	3124.1	0.03	94.67

Light Distribution Data

Unit: cd

G\C	C0.0	C22.5	C45.0	C67.5	C90.0	C112.5	C135.0	C157.5
G0.0	1083.4	1083.4	1083.4	1083.4	1083.4	1083.4	1083.4	1083.4
G1.0	1083.4	1082.9	1083.1	1082.9	1083.5	1083.1	1083.5	1083.1
G2.0	1083.1	1082.2	1083.0	1082.1	1083.1	1082.3	1083.3	1082.6
G3.0	1082.2	1081.2	1081.9	1081.0	1082.2	1081.4	1082.3	1081.4
G4.0	1081.2	1079.8	1080.7	1079.5	1080.9	1079.8	1081.2	1080.2
G5.0	1079.5	1077.8	1079.0	1077.5	1079.3	1077.5	1079.6	1078.3
G6.0	1077.7	1075.9	1077.1	1075.0	1077.1	1075.2	1077.7	1076.2
G7.0	1075.5	1073.2	1074.7	1072.3	1074.8	1072.5	1075.5	1073.9
G8.0	1073.1	1069.8	1072.1	1069.2	1071.9	1069.4	1073.0	1071.1
G9.0	1069.7	1066.7	1069.0	1065.0	1068.0	1065.9	1069.9	1067.4
G10.0	1066.2	1063.1	1065.6	1061.1	1064.3	1062.0	1066.5	1063.9
G11.0	1062.7	1059.1	1061.5	1056.8	1060.1	1057.8	1061.9	1059.9
G12.0	1058.8	1054.8	1056.7	1051.9	1055.5	1051.9	1057.9	1055.7
G13.0	1054.5	1050.0	1052.0	1046.8	1050.9	1047.1	1053.3	1051.1
G14.0	1050.1	1045.1	1047.1	1041.4	1045.6	1041.6	1048.3	1046.1
G15.0	1044.8	1038.6	1041.8	1034.3	1040.0	1035.8	1043.1	1040.9
G16.0	1039.3	1032.8	1035.9	1028.1	1033.9	1029.5	1037.5	1034.0
G17.0	1032.8	1026.6	1029.9	1021.3	1026.3	1022.8	1030.3	1028.1
G18.0	1026.7	1020.2	1022.3	1014.5	1019.4	1015.9	1023.8	1021.6
G19.0	1020.3	1013.6	1015.6	1007.1	1012.4	1007.4	1017.2	1015.1
G20.0	1013.5	1006.4	1008.3	999.4	1004.8	999.5	1010.1	1008.0
G21.0	1006.5	997.4	1000.7	991.5	996.8	991.5	1002.5	1000.7
G22.0	999.1	989.5	993.0	981.2	988.6	983.1	994.9	992.9
G23.0	989.9	981.3	984.7	972.5	978.5	974.2	986.8	983.3
G24.0	981.8	973.0	974.6	963.5	969.5	965.4	976.6	974.9
G25.0	973.3	964.2	965.7	954.1	960.1	954.0	967.7	966.1
G26.0	964.4	954.9	956.4	944.3	950.4	944.3	958.4	957.0
G27.0	955.5	945.5	946.9	934.3	940.5	934.1	949.0	947.6
G28.0	946.1	933.8	937.1	923.9	930.4	923.7	939.2	937.7
G29.0	936.5	923.8	927.0	911.2	917.7	913.3	929.2	925.9
G30.0	924.4	913.3	916.6	900.2	906.9	902.3	918.6	915.5
G31.0	914.0	902.5	903.5	888.9	895.6	888.6	905.7	904.7
G32.0	903.3	891.5	892.5	877.4	884.1	877.0	894.7	893.7
G33.0	892.4	880.2	881.4	865.7	872.6	865.3	883.5	882.4
G34.0	881.3	866.4	869.8	853.7	860.8	853.3	871.9	871.0
G35.0	869.7	854.5	857.8	838.7	848.4	840.8	859.8	856.7
G36.0	857.7	842.3	845.6	826.2	833.4	828.3	847.5	844.6
G37.0	843.3	829.7	830.6	813.1	820.7	815.3	832.8	831.8
G38.0	830.9	817.0	818.0	800.1	807.8	799.7	820.2	819.3
G39.0	818.2	804.1	805.0	787.0	794.6	786.4	806.9	806.4

Test Type : Type C

Test Distance : 8.460 m

C Plane (°): 0.0-360.0:22.5

γ (°): 0.0-90.0:1.0

Test Device : LSG-1890B

Temperature : 25°C

Humidity : 65.0%

Test Lab : LISUN GROUP

Test By : Thomas Fiodorow

Review By :

Light Distribution Data

Unit: cd

G\C	C0.0	C22.5	C45.0	C67.5	C90.0	C112.5	C135.0	C157.5
G40.0	805.0	790.7	791.6	773.4	780.9	772.7	793.6	792.9
G41.0	791.9	774.6	778.0	756.7	767.2	758.9	780.0	779.5
G42.0	778.5	760.6	764.5	742.6	753.5	744.8	766.4	762.6
G43.0	762.2	746.6	750.8	728.5	736.9	730.5	750.0	748.5
G44.0	748.5	732.5	734.1	714.1	722.8	716.3	736.0	734.4
G45.0	734.0	718.0	719.7	699.7	708.2	698.8	721.5	719.9
G46.0	719.7	703.4	705.1	684.9	693.4	683.9	706.7	705.1
G47.0	705.1	688.5	690.3	670.1	679.0	669.1	692.2	690.3
G48.0	690.6	671.0	675.7	652.4	664.3	654.4	677.4	675.5
G49.0	672.3	655.9	660.6	637.4	649.2	639.4	659.1	657.2
G50.0	657.0	640.7	645.2	622.1	630.8	624.2	643.7	642.0
G51.0	641.5	625.4	626.6	607.0	615.4	605.8	628.2	626.6
G52.0	626.1	609.8	611.5	591.4	600.3	590.2	612.9	610.7
G53.0	611.2	591.2	596.5	576.2	585.2	574.9	597.6	595.2
G54.0	593.1	575.9	578.5	558.0	567.3	559.8	579.5	576.6
G55.0	577.6	560.8	563.0	543.0	552.1	541.7	564.1	561.2
G56.0	559.5	542.5	548.1	525.1	534.3	526.6	546.0	542.8
G57.0	544.5	527.4	530.3	510.2	519.8	508.8	531.2	527.6
G58.0	526.7	509.9	512.7	493.1	502.4	494.5	513.5	509.9
G59.0	509.0	492.4	498.2	475.9	487.9	477.3	495.8	495.2
G60.0	494.2	477.9	480.6	461.6	470.5	460.1	481.0	477.5
G61.0	476.7	460.7	463.5	444.9	453.7	443.2	463.9	460.2
G62.0	459.8	443.7	446.9	428.2	437.3	426.5	447.2	442.9
G63.0	440.4	427.3	430.5	412.1	421.0	410.5	430.6	426.3
G64.0	423.9	408.3	414.2	393.7	402.5	394.6	411.5	409.9
G65.0	407.5	392.3	395.5	378.1	386.5	378.9	395.3	390.9
G66.0	389.0	376.5	380.0	362.7	371.2	360.9	377.1	375.0
G67.0	373.5	358.5	362.2	345.2	353.8	345.8	361.9	356.8
G68.0	356.1	341.4	345.1	328.5	336.9	329.0	344.6	341.9
G69.0	338.6	324.5	327.9	312.0	320.1	312.4	327.3	324.7
G70.0	321.5	307.9	311.3	295.8	303.7	296.1	310.5	307.8
G71.0	305.1	291.8	295.3	280.2	288.0	280.4	294.4	289.2
G72.0	287.1	275.9	277.7	264.8	270.6	262.9	276.7	273.1
G73.0	269.9	258.8	263.0	248.2	254.1	248.2	259.6	255.9
G74.0	254.9	242.2	246.3	232.0	239.8	232.0	245.0	239.0
G75.0	236.4	226.2	230.1	216.4	222.1	216.3	226.7	222.7
G76.0	220.8	210.7	213.0	201.4	207.0	199.3	211.4	207.1
G77.0	204.1	194.1	196.6	185.4	191.0	184.9	194.9	190.3
G78.0	188.0	178.4	181.1	170.1	175.7	169.6	179.2	174.4
G79.0	170.7	161.7	165.8	155.6	160.7	153.3	162.2	159.1

Test Type : Type C

Test Distance : 8.460 m

C Plane (°): 0.0-360.0:22.5

γ (°): 0.0-90.0:1.0

Test Device : LSG-1890B

Temperature : 25°C

Humidity : 65.0%

Test Lab : LISUN GROUP

Test By : Thomas Fiodorow

Review By :

Report No. : LISUN-002

Test Time : 2023-01-03 15:40:15

Page 19 of 22

Light Distribution Data

Unit: cd

G\C	C0.0	C22.5	C45.0	C67.5	C90.0	C112.5	C135.0	C157.5
G80.0	154.4	147.3	149.9	140.1	145.2	137.9	147.8	143.0
G81.0	139.2	130.7	133.5	125.5	129.1	123.3	131.3	127.8
G82.0	123.5	116.4	118.3	110.3	114.1	108.0	116.0	111.9
G83.0	107.7	100.6	103.0	95.2	99.1	94.2	100.4	97.3
G84.0	92.8	86.1	88.5	81.2	85.0	79.0	85.9	81.5
G85.0	77.0	71.5	73.1	67.2	70.1	65.0	70.5	66.8
G86.0	61.8	56.3	58.6	52.8	55.9	51.5	55.9	52.7
G87.0	46.2	41.8	43.7	39.2	41.4	37.9	40.9	37.5
G88.0	31.4	27.7	29.3	26.1	27.7	24.1	26.9	24.3
G89.0	16.9	14.5	15.5	13.4	14.8	12.8	14.4	12.5
G90.0	6.6	5.3	4.8	4.3	4.9	5.2	5.8	5.1

Test Type : Type C

Test Distance : 8.460 m

C Plane (°): 0.0-360.0:22.5

γ (°): 0.0-90.0:1.0

Test Device : LSG-1890B

Temperature : 25°C

Humidity : 65.0%

Test Lab : LISUN GROUP

Test By : Thomas Fiodorow

Review By :

Light Distribution Data

Unit: cd

G\C	C180.0	C202.5	C225.0	C247.5	C270.0	C292.5	C315.0	C337.5
G0.0	1083.4	1083.4	1083.4	1083.4	1083.4	1083.4	1083.4	1083.4
G1.0	1083.1	1083.2	1082.9	1083.1	1083.1	1083.3	1083.0	1083.2
G2.0	1082.6	1083.0	1082.1	1082.8	1082.3	1083.1	1082.3	1083.1
G3.0	1081.4	1082.0	1080.8	1081.8	1081.1	1081.9	1081.0	1082.1
G4.0	1079.7	1081.0	1079.4	1080.5	1079.2	1080.5	1079.2	1080.8
G5.0	1077.8	1079.5	1077.5	1078.8	1076.9	1078.7	1077.3	1079.0
G6.0	1075.8	1077.4	1075.0	1076.3	1074.5	1076.7	1074.8	1077.0
G7.0	1073.4	1075.1	1072.5	1073.9	1071.5	1074.2	1072.0	1074.9
G8.0	1070.6	1072.6	1069.4	1071.0	1068.3	1071.3	1069.0	1071.9
G9.0	1067.5	1069.5	1066.2	1067.7	1064.7	1067.4	1065.7	1069.0
G10.0	1063.9	1066.3	1061.4	1064.1	1060.7	1063.6	1061.8	1065.7
G11.0	1060.1	1062.8	1057.3	1060.1	1056.1	1059.6	1057.8	1061.4
G12.0	1055.1	1058.7	1052.8	1054.7	1050.3	1055.3	1052.1	1057.2
G13.0	1050.6	1053.4	1047.9	1049.8	1045.1	1050.2	1047.4	1053.0
G14.0	1045.7	1048.6	1042.7	1044.5	1039.5	1045.0	1042.1	1047.8
G15.0	1040.3	1043.7	1037.1	1039.0	1033.4	1039.4	1036.2	1042.8
G16.0	1035.0	1038.2	1031.0	1032.9	1026.9	1032.4	1030.2	1037.3
G17.0	1029.0	1032.5	1023.3	1026.7	1020.2	1026.0	1024.0	1031.6
G18.0	1021.6	1026.4	1016.8	1020.2	1013.4	1019.2	1016.0	1024.2
G19.0	1015.0	1019.9	1009.7	1011.7	1004.3	1012.2	1008.8	1017.6
G20.0	1008.2	1011.7	1002.0	1004.0	996.4	1004.8	1001.3	1010.8
G21.0	1000.6	1004.6	994.2	996.3	988.2	996.9	993.6	1003.5
G22.0	993.2	997.3	986.4	988.3	979.7	987.3	985.5	996.2
G23.0	985.3	989.4	976.4	979.9	971.0	978.9	977.1	988.4
G24.0	975.4	981.3	967.5	970.9	961.8	969.8	966.6	978.4
G25.0	966.6	972.8	958.1	961.8	950.3	960.8	957.2	969.8
G26.0	957.7	962.2	948.8	950.5	940.3	951.4	947.8	961.0
G27.0	948.4	953.2	939.1	940.7	930.4	941.8	938.3	951.9
G28.0	938.9	943.6	929.2	930.6	919.8	931.7	928.2	942.4
G29.0	928.9	933.6	918.8	920.2	909.1	919.1	917.7	932.5
G30.0	918.6	923.6	905.9	909.4	898.1	908.4	907.1	922.2
G31.0	906.0	913.1	894.9	898.4	886.6	897.4	894.0	909.6
G32.0	895.1	900.4	883.7	884.9	873.0	886.2	882.8	898.9
G33.0	884.2	889.2	872.3	873.2	861.0	874.6	871.4	887.8
G34.0	872.6	877.7	860.3	861.3	848.8	862.6	859.5	876.4
G35.0	860.6	866.1	847.9	849.2	836.2	850.6	847.2	864.6
G36.0	848.5	854.3	835.5	836.8	823.7	835.7	834.9	852.8
G37.0	836.2	841.8	820.4	824.3	810.9	823.2	822.3	840.6
G38.0	821.3	829.3	807.6	811.2	795.3	810.2	807.1	825.6
G39.0	808.0	816.4	794.3	798.0	781.8	797.0	793.7	812.7

Test Type : Type C

Test Distance : 8.460 m

C Plane (°): 0.0-360.0:22.5

γ (°): 0.0-90.0:1.0

Test Device : LSG-1890B

Temperature : 25°C

Humidity : 65.0%

Test Lab : LISUN GROUP

Test By : Thomas Fiodorow

Review By :

Light Distribution Data

Unit: cd

G\C	C180.0	C202.5	C225.0	C247.5	C270.0	C292.5	C315.0	C337.5
G40.0	794.6	800.7	780.6	781.9	767.9	783.6	780.0	799.6
G41.0	781.1	787.4	766.9	768.3	754.1	770.3	766.4	786.5
G42.0	767.5	774.1	753.2	754.8	740.3	756.8	752.8	773.2
G43.0	753.7	760.2	739.4	740.8	726.4	740.0	738.9	759.1
G44.0	739.3	746.1	721.9	726.5	711.7	725.8	724.5	745.2
G45.0	724.6	731.8	707.2	712.1	697.1	711.5	709.7	728.1
G46.0	707.1	714.4	692.6	694.8	679.6	696.9	692.4	713.8
G47.0	692.3	699.7	678.0	680.0	664.9	682.2	677.8	699.0
G48.0	677.5	684.5	663.1	665.0	650.3	667.3	663.0	684.1
G49.0	661.9	669.5	647.7	650.1	635.0	652.3	647.9	669.1
G50.0	646.5	654.1	632.5	634.8	619.8	634.1	632.6	653.9
G51.0	631.1	638.7	614.1	619.5	604.8	619.0	614.2	638.7
G52.0	612.4	623.2	598.6	604.3	586.5	603.8	598.9	620.1
G53.0	596.8	604.5	583.3	586.0	571.4	588.4	583.8	604.9
G54.0	581.1	589.1	567.8	570.8	556.1	570.4	568.5	589.5
G55.0	562.4	573.7	549.4	555.8	541.1	555.2	550.5	571.3
G56.0	547.3	555.6	534.5	538.0	523.4	540.6	535.6	556.4
G57.0	529.0	537.4	516.7	520.2	506.0	523.0	518.0	538.4
G58.0	514.2	522.3	502.0	505.6	491.5	505.2	503.4	523.4
G59.0	496.1	504.5	484.3	488.2	474.1	490.8	485.9	505.7
G60.0	478.4	486.8	467.1	471.2	457.2	473.7	468.8	488.2
G61.0	463.9	469.6	450.2	454.3	443.4	457.0	452.1	471.1
G62.0	446.8	452.3	433.6	437.7	424.4	440.3	435.6	454.0
G63.0	427.2	435.5	417.2	421.2	408.3	423.9	419.4	437.2
G64.0	410.4	418.8	400.7	405.1	392.3	407.8	403.2	420.8
G65.0	393.8	402.6	384.7	389.4	376.6	389.4	387.2	404.7
G66.0	378.0	384.0	366.6	371.6	359.0	374.2	369.4	386.4
G67.0	359.8	368.3	351.5	356.4	344.3	356.5	352.0	368.2
G68.0	342.0	350.4	334.2	339.0	327.3	339.2	337.3	353.1
G69.0	324.4	333.0	317.1	322.2	310.7	324.8	320.5	335.9
G70.0	307.4	316.1	300.5	305.9	294.5	306.2	304.0	319.1
G71.0	291.2	299.8	284.7	290.1	279.0	290.5	286.2	300.6
G72.0	275.3	281.3	267.1	272.4	263.9	275.0	270.9	284.7
G73.0	257.7	263.8	252.1	255.3	247.2	257.9	254.1	267.2
G74.0	240.5	248.8	235.3	240.9	230.9	241.5	237.5	250.3
G75.0	224.0	230.4	219.2	223.2	215.1	225.7	221.7	234.2
G76.0	208.3	214.8	203.9	208.0	200.3	208.7	206.7	218.7
G77.0	191.4	197.6	187.5	191.5	184.2	194.0	190.4	201.6
G78.0	175.1	181.3	171.7	175.8	168.7	178.3	175.0	185.5
G79.0	159.5	165.8	156.4	160.8	153.9	161.7	158.3	168.4

Test Type : Type C

Test Distance : 8.460 m

C Plane (°): 0.0-360.0:22.5

γ (°): 0.0-90.0:1.0

Test Device : LSG-1890B

Temperature : 25°C

Humidity : 65.0%

Test Lab : LISUN GROUP

Test By : Thomas Fiodorow

Review By :

Report No. : LISUN-002

Test Time : 2023-01-03 15:40:15

Page 22 of 22

Light Distribution Data

Unit: cd

G\C	C180.0	C202.5	C225.0	C247.5	C270.0	C292.5	C315.0	C337.5
G80.0	143.0	149.6	140.3	145.2	138.2	146.1	144.1	152.5
G81.0	127.6	132.8	125.3	129.1	123.8	131.5	127.9	137.5
G82.0	111.8	116.8	110.0	113.7	108.7	116.1	113.0	121.6
G83.0	97.0	102.2	94.4	98.3	93.7	100.6	97.8	105.7
G84.0	81.8	86.0	79.5	84.1	79.5	86.3	83.6	90.9
G85.0	66.7	70.4	64.9	69.1	65.7	71.4	68.9	75.5
G86.0	52.1	55.5	50.9	54.8	51.4	56.1	54.9	59.6
G87.0	37.5	40.6	36.5	39.7	38.0	41.8	40.4	44.7
G88.0	23.1	25.4	22.8	26.1	24.7	28.1	26.7	30.2
G89.0	11.8	12.5	10.8	13.2	12.6	15.3	14.4	16.3
G90.0	4.6	4.3	4.0	4.2	4.9	6.1	7.3	6.9

Test Type : Type C

Test Distance : 8.460 m

C Plane (°): 0.0-360.0:22.5

γ (°): 0.0-90.0:1.0

Test Device : LSG-1890B

Temperature : 25°C

Humidity : 65.0%

Test Lab : LISUN GROUP

Test By : Thomas Fiodorow

Review By :

Report No. : LISUN-003

Test Time : 2023-01-03 16:45:44

Page 1 of 31

Lisun Goniophotometer Test Report

Product Info

Luminaire Category : **Flood**
 Luminaire : **BT-EF295**
 Lamp Category : **CREE**
 Lamp : **011507**
 Manufacturer : **Philips Lighting B.V.**
 Submitter : **Michael Aslami**
 Number of Lamps : **1** Lumens per Lamp : **9000 lm**
 Luminous Length : **230 mm** Luminous Width : **135 mm** Luminous Height : **0 mm**

Electric Parameters

Voltage : **230.00 V** Current : **0.4948 A** Power : **106.44 W** Power Factor : **0.936** Frequency : **50.00 Hz**

Photometric Parameters

IES NEMA Type : 7H x 7V Measurement Flux : 8844.4 lm Field Lumens : 8673.6 lm Central Intensity : 3248.14 cd Position Of Maximum Intensity : H-1° V0° Energy Efficiency Class : G (EU 2019/2015 η_{TM}:82lm/W) Beam Angle (Vertical) : 109.5 ° Field Angle (Vertical) : 147.4 °	Total Rated Lamp Lumens : 9000.0 lm Efficiency : 98.27 % Field Efficiency : 96.37 % Maximum Intensity : 3249.04 cd Luminaire Efficacy Rating (LER) : 83 Beam Angle (Horizontal) : 113.0 ° Field Angle (Horizontal) : 150.2 °
--	---

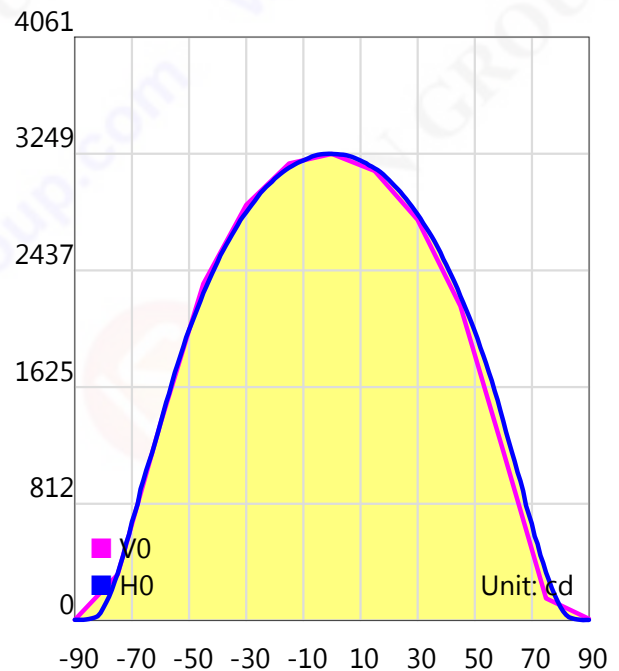

Test Type : Type B	Test Distance : 8.460 m	B Plane (°): -90.0-90.0:15.0	β (°) : -90.0-90.0:1.0
Test Device : LSG-1890B	Temperature : 25°C	Humidity : 65.0%	
Test Lab : LISUN GROUP	Review By :		
Test By : Thomas Fiodorow			

Light Distribution Curve

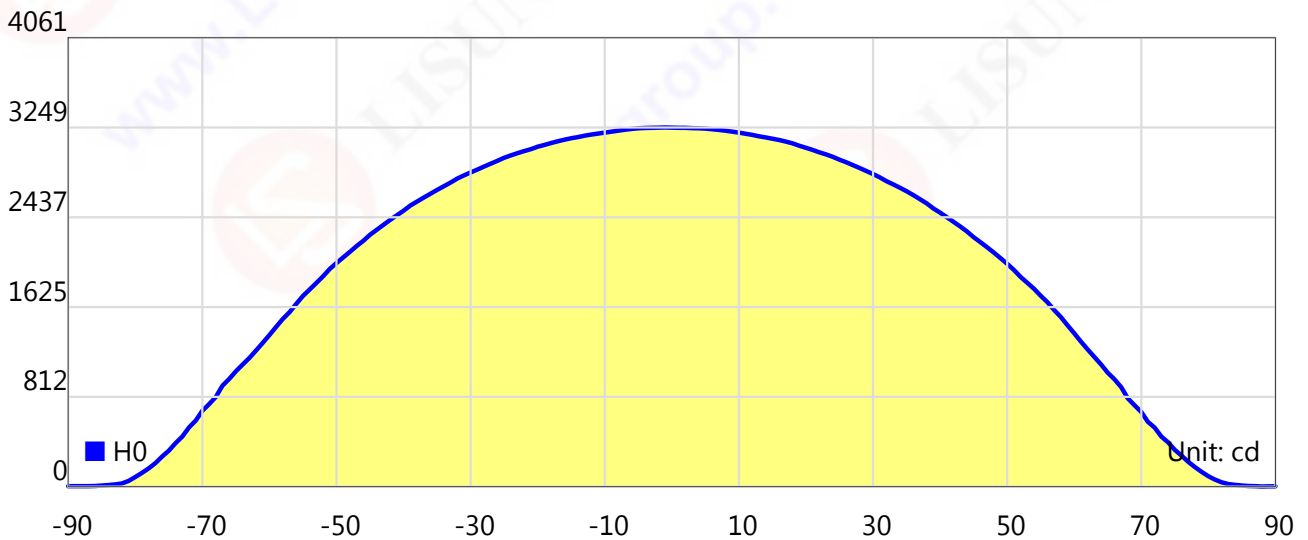
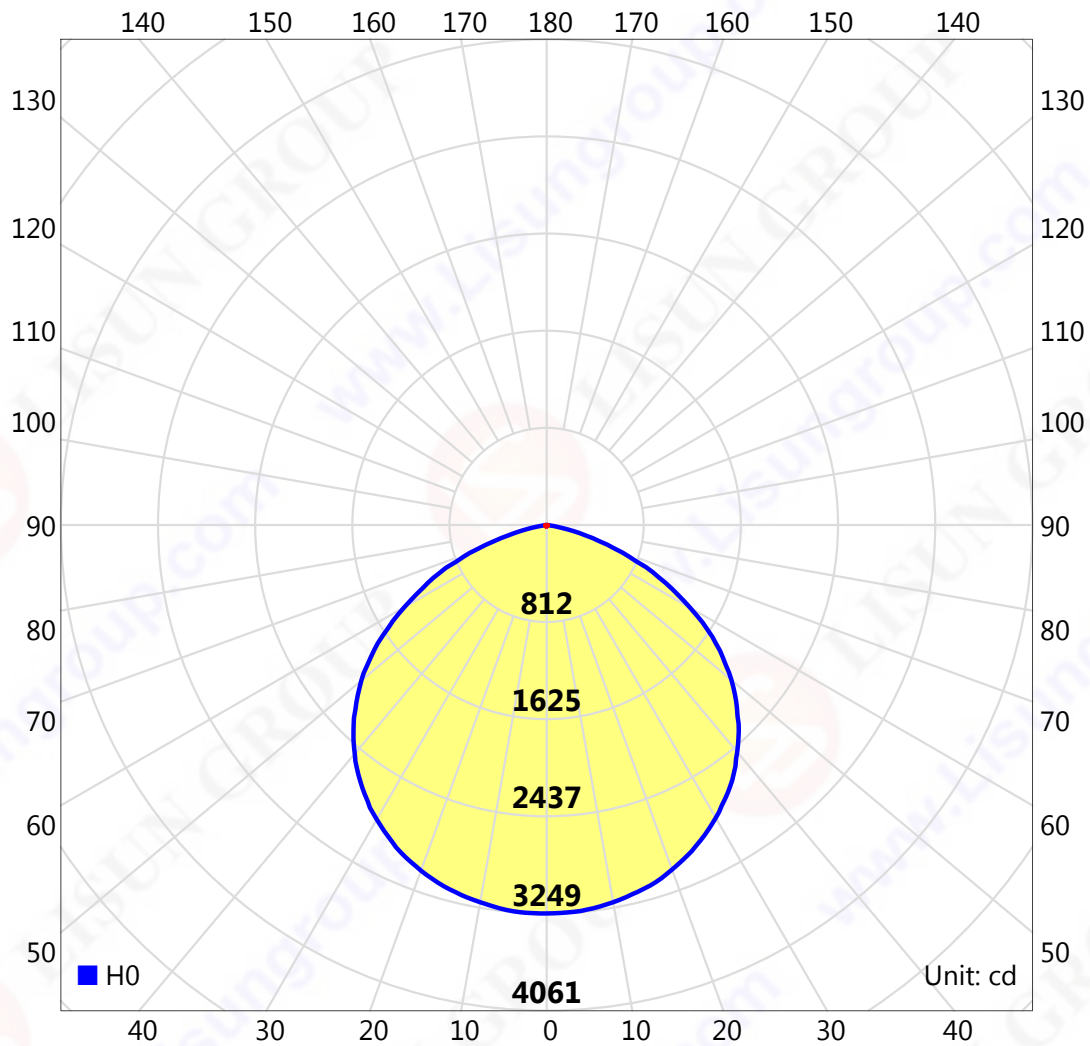

Light Distribution Curve (cd/klm)

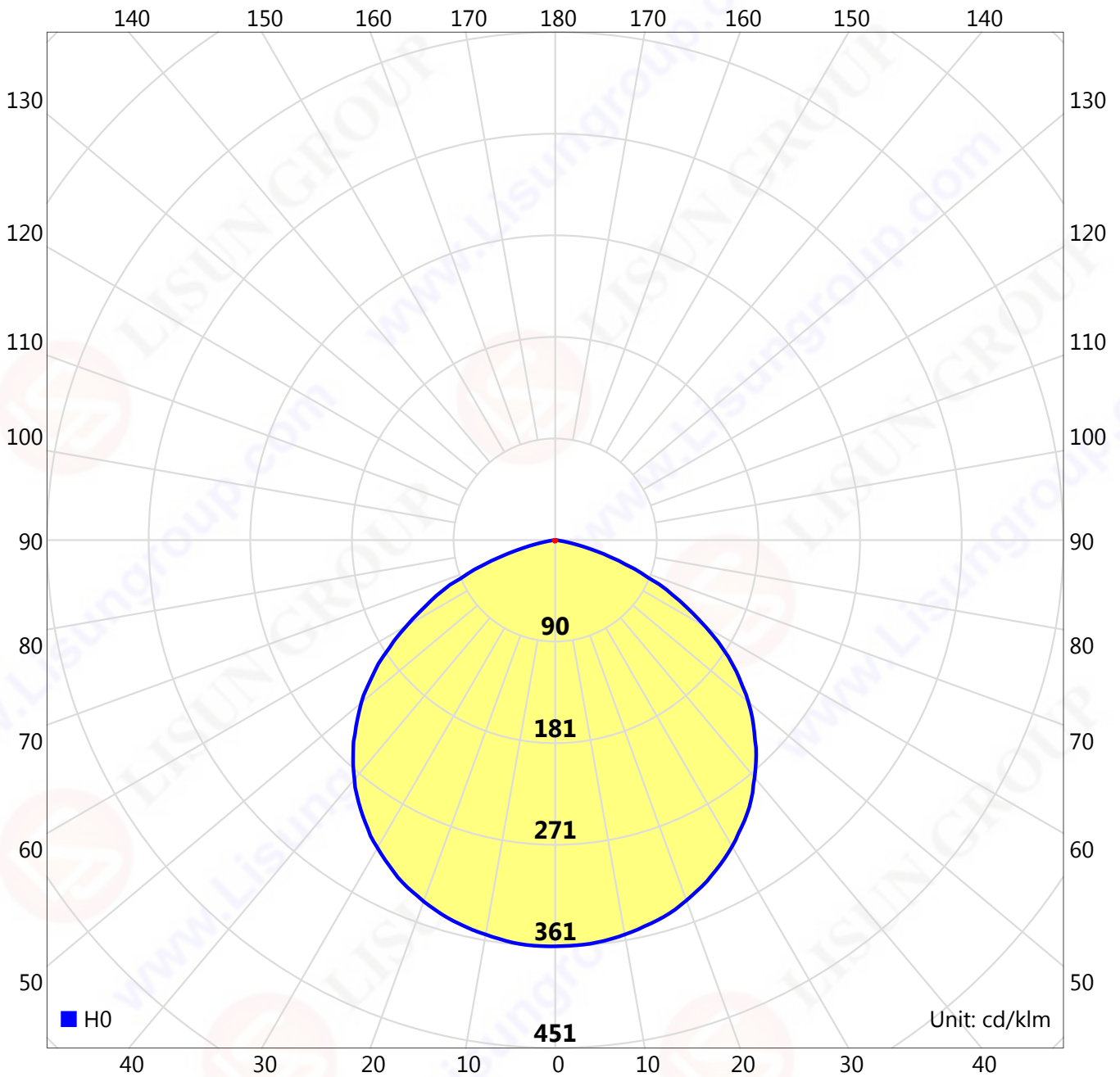

011507/CREE

$\eta=98.27\%$

Report No. : LISUN-003

Test Time : 2023-01-03 16:45:44

Page 4 of 31

Warmup Log

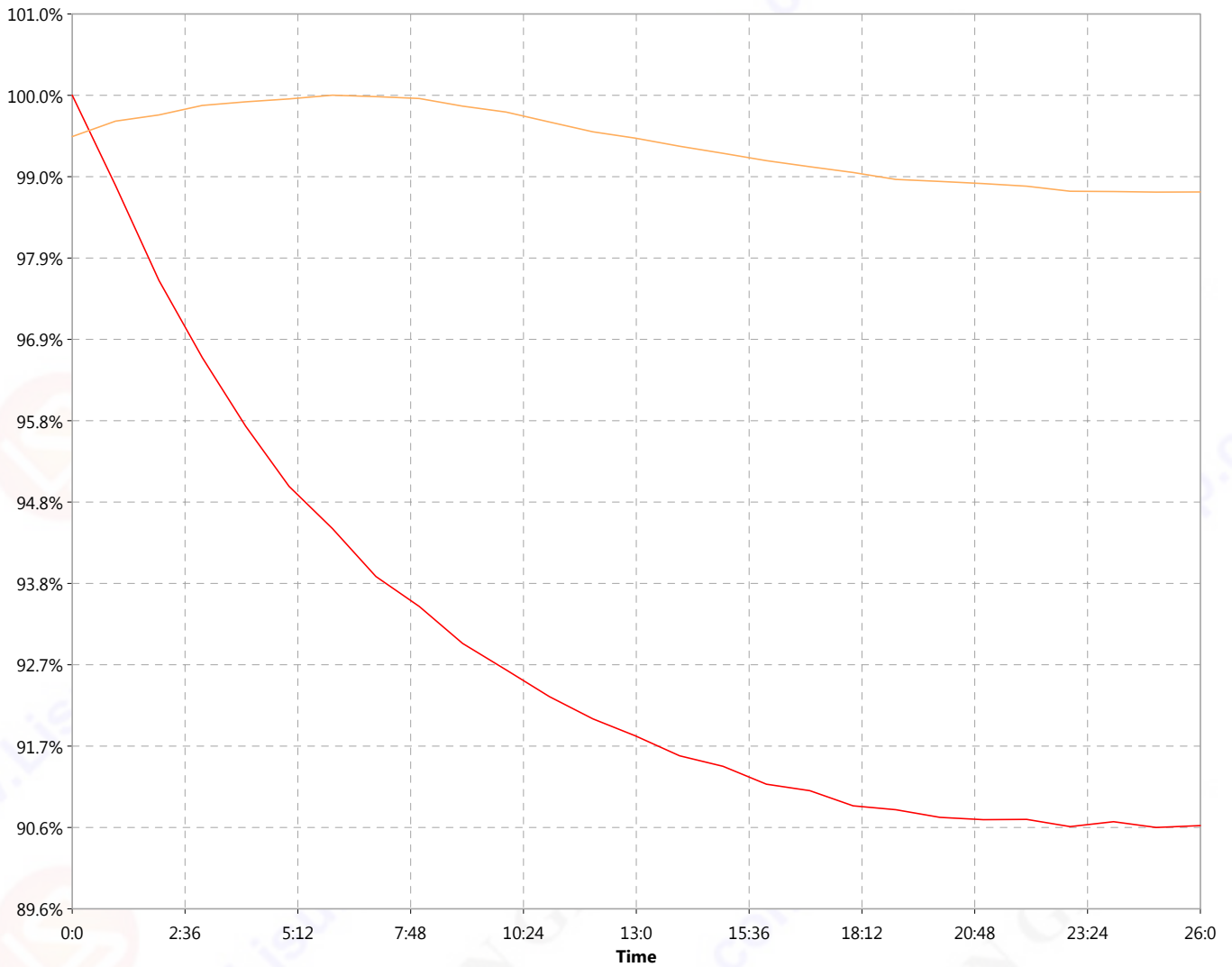

Stable time: 26:0

Uptime: 0:0

Parameters	Maximum	Minimum	Change
Luminous intensity ,cd	3585.48	3249.97	335.51
Power ,W	107.97	106.64	1.34

Test Type : Type B

Test Distance : 8.460 m

B Plane (°): -90.0-90.0:15.0 β (°): -90.0-90.0:1.0

Test Device : LSG-1890B

Temperature : 25°C

Humidity : 65.0%

Test Lab : LISUN GROUP

Test By : Thomas Fiodorow

Review By :

Area Flux

		Vertical																		Horizontal		
∅(E)	∅(T)	-90	-80	-70	-60	-50	-40	-30	-20	-10	0	10	20	30	40	50	60	70	80	90	∅(T)	∅(E)
00	08	0.0	0.1	0.2	0.5	1.1	1.8	2.4	3.0	3.3	3.3	3.0	2.4	1.7	1.0	0.5	0.1	0.0	0.0	0.0	24.3	0.0
00	08	0.0	0.1	0.5	1.8	3.9	6.4	8.7	10.5	11.5	11.4	10.4	8.6	6.2	3.7	1.7	0.5	0.1	0.0	0.0	86.1	43.5
00	00	0.3	2.0	6.1	11.8	18.2	24.0	28.4	30.7	30.7	30.7	28.3	23.9	18.2	11.7	6.0	2.0	0.3	0.0	0.0	242.5	233.4
00	00	0.7	4.4	11.8	21.5	31.9	41.0	47.6	51.1	51.0	51.0	47.3	40.5	31.4	21.1	11.3	4.1	0.6	0.0	0.0	417.4	412.9
00	00	1.3	7.4	18.2	31.8	45.4	57.0	65.4	69.7	69.4	64.7	55.9	44.1	30.7	17.2	6.7	1.1	0.0	0.0	0.0	586.2	583.3
00	00	1.8	9.6	22.6	38.6	54.2	67.4	76.9	81.8	81.6	76.5	66.8	53.5	38.1	22.4	9.3	1.8	0.0	0.0	0.0	702.9	700.7
01	01	2.4	11.6	26.3	43.9	60.7	74.9	85.0	90.2	90.1	84.6	74.2	60.0	43.3	26.1	11.2	2.3	0.1	0.1	0.1	787.0	785.2
01	01	2.9	13.2	29.4	47.8	65.3	79.9	90.3	95.5	95.3	89.6	78.7	63.8	46.3	28.2	12.4	2.6	0.1	0.1	0.1	841.5	839.9
01	01	3.0	13.5	30.0	48.8	66.6	81.4	92.0	97.4	97.3	91.6	80.7	65.7	48.0	29.6	13.2	2.9	0.1	0.1	0.1	861.8	860.3
01	01	3.0	13.4	29.8	48.5	66.2	80.9	91.4	96.9	96.8	91.1	80.3	65.3	47.6	29.4	13.0	2.8	0.1	0.1	0.1	856.6	855.1
01	01	2.9	13.0	28.8	47.0	64.2	78.5	88.7	94.0	94.0	88.0	77.3	62.6	45.3	27.5	11.9	2.5	0.1	0.1	0.1	826.2	824.5
01	01	2.3	11.2	25.6	42.7	59.0	72.7	82.5	87.7	87.5	82.1	72.0	58.0	41.7	25.0	10.6	2.1	0.1	0.1	0.1	762.8	760.9
01	01	1.7	9.0	21.5	36.9	51.8	64.4	73.5	78.2	78.0	73.0	63.6	50.8	36.0	21.0	8.6	1.6	0.0	0.0	0.0	669.8	667.5
00	00	1.2	6.7	16.8	29.6	42.4	53.2	61.1	65.1	64.9	60.3	52.0	40.8	28.1	15.5	5.9	1.0	0.0	0.0	0.0	544.5	541.3
00	00	0.6	3.7	10.3	19.2	28.6	36.8	42.7	45.7	45.5	42.1	35.8	27.5	18.1	9.5	3.3	0.5	0.0	0.0	0.0	370.0	364.6
00	00	0.3	1.6	4.9	9.7	15.1	20.0	23.5	25.3	25.1	23.0	19.3	14.5	9.1	4.5	1.4	0.2	0.0	0.0	0.0	197.5	185.6
00	00	0.1	0.5	1.3	2.5	4.0	5.4	6.4	6.9	6.8	6.2	5.1	3.7	2.3	1.1	0.4	0.1	0.0	0.0	0.0	53.0	14.9
00	00	0.1	0.2	0.4	0.7	1.1	1.5	1.7	1.8	1.8	1.6	1.3	0.9	0.6	0.3	0.2	0.1	0.0	0.0	0.0	14.4	0.0
08	08	24.6	121.6	286.2	486.1	683.0	850.3	970.6	1033	1030	963.4	838.3	668.6	472.7	276.7	114.9	22.7	0.7	0.7	0.7	8845	-----
00	00	13.6	112.9	277.1	477.2	672.9	839.0	957.9	1020	1017	950.9	827.1	658.9	464.0	267.6	105.5	11.8	0.0	0.0	0.0	-----	867.4

Unit: lm

IsoCandela

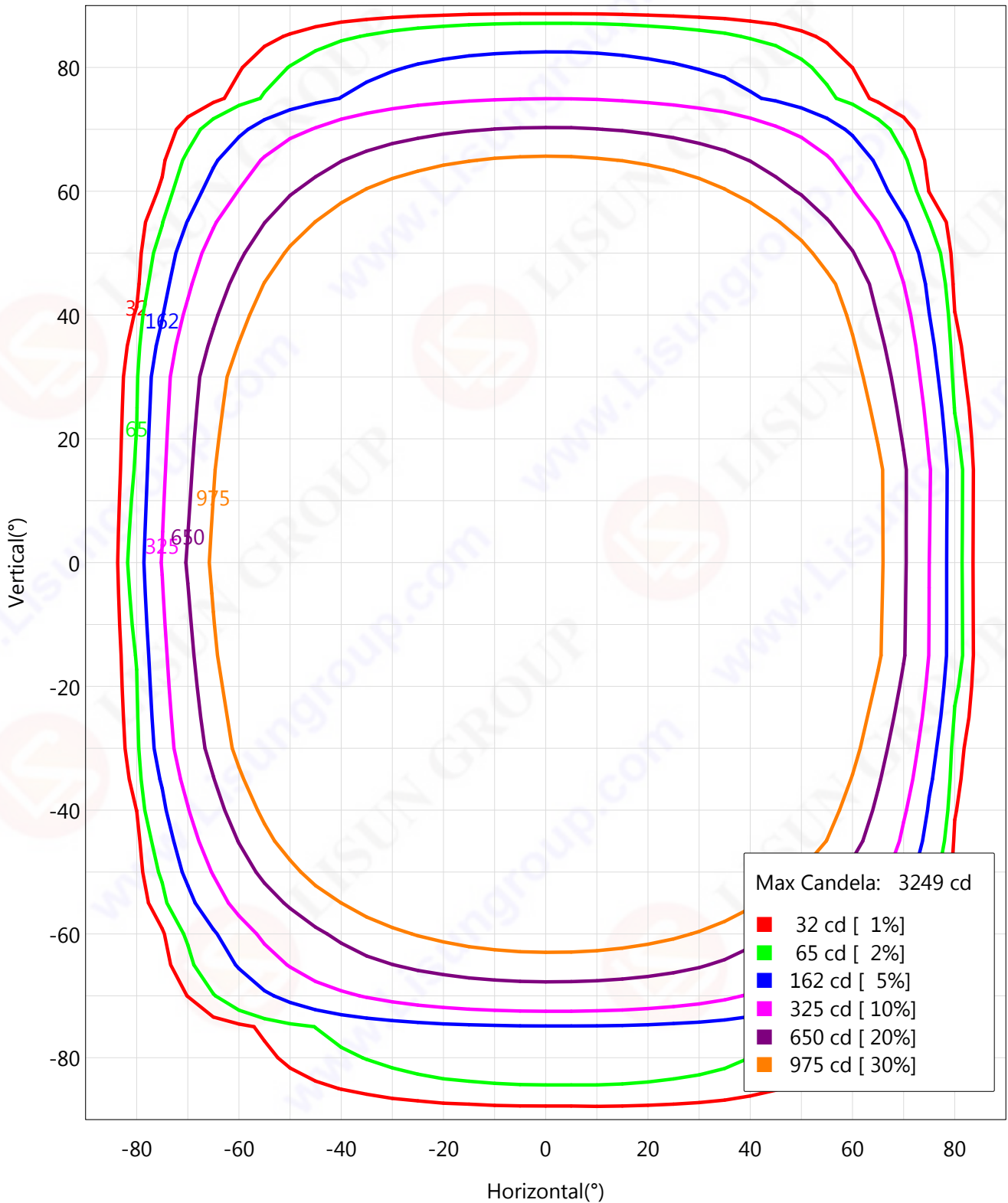

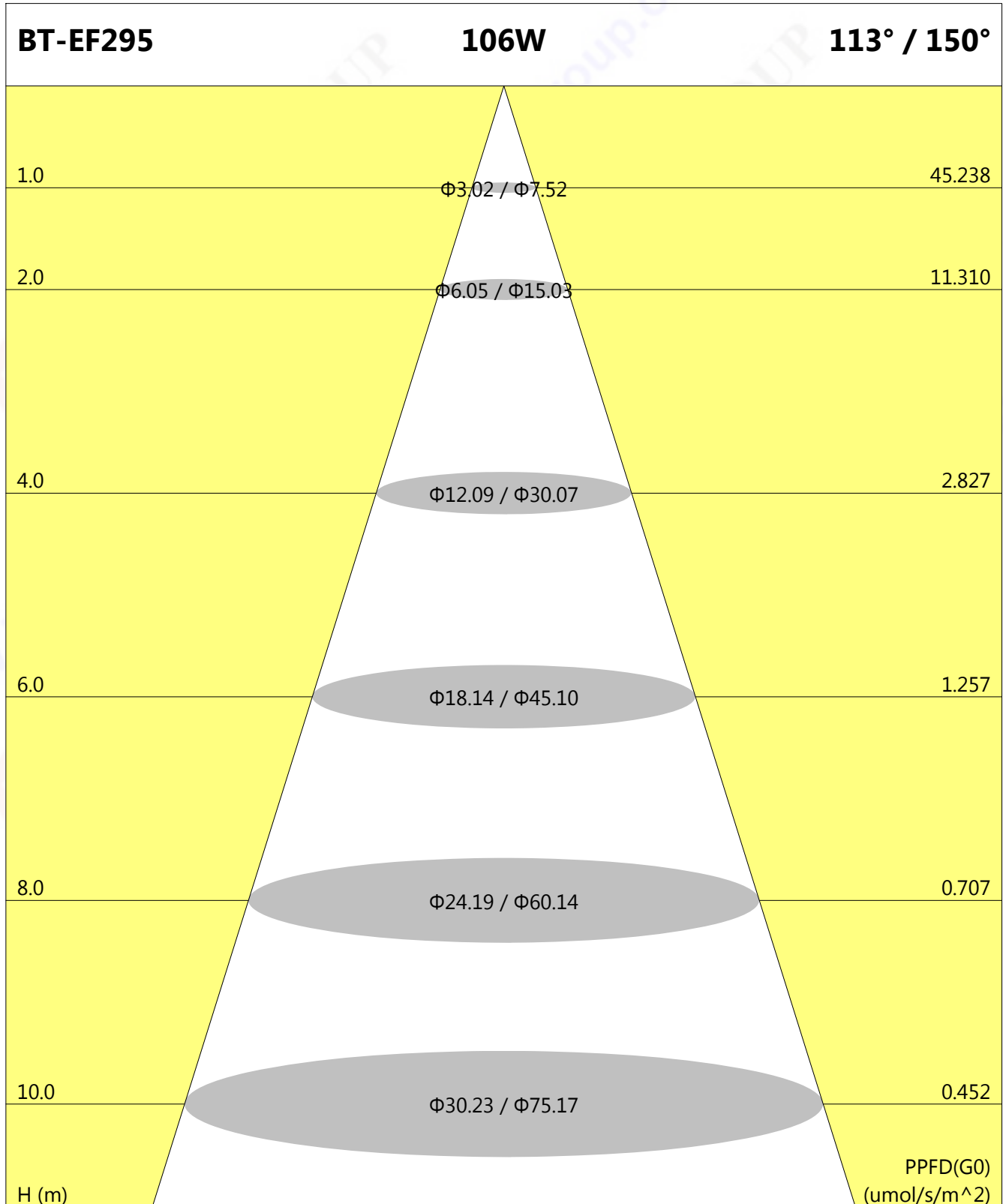
PPFD-Distance

Report No. : LISUN-003

Test Time : 2023-01-03 16:45:44

Page 8 of 31

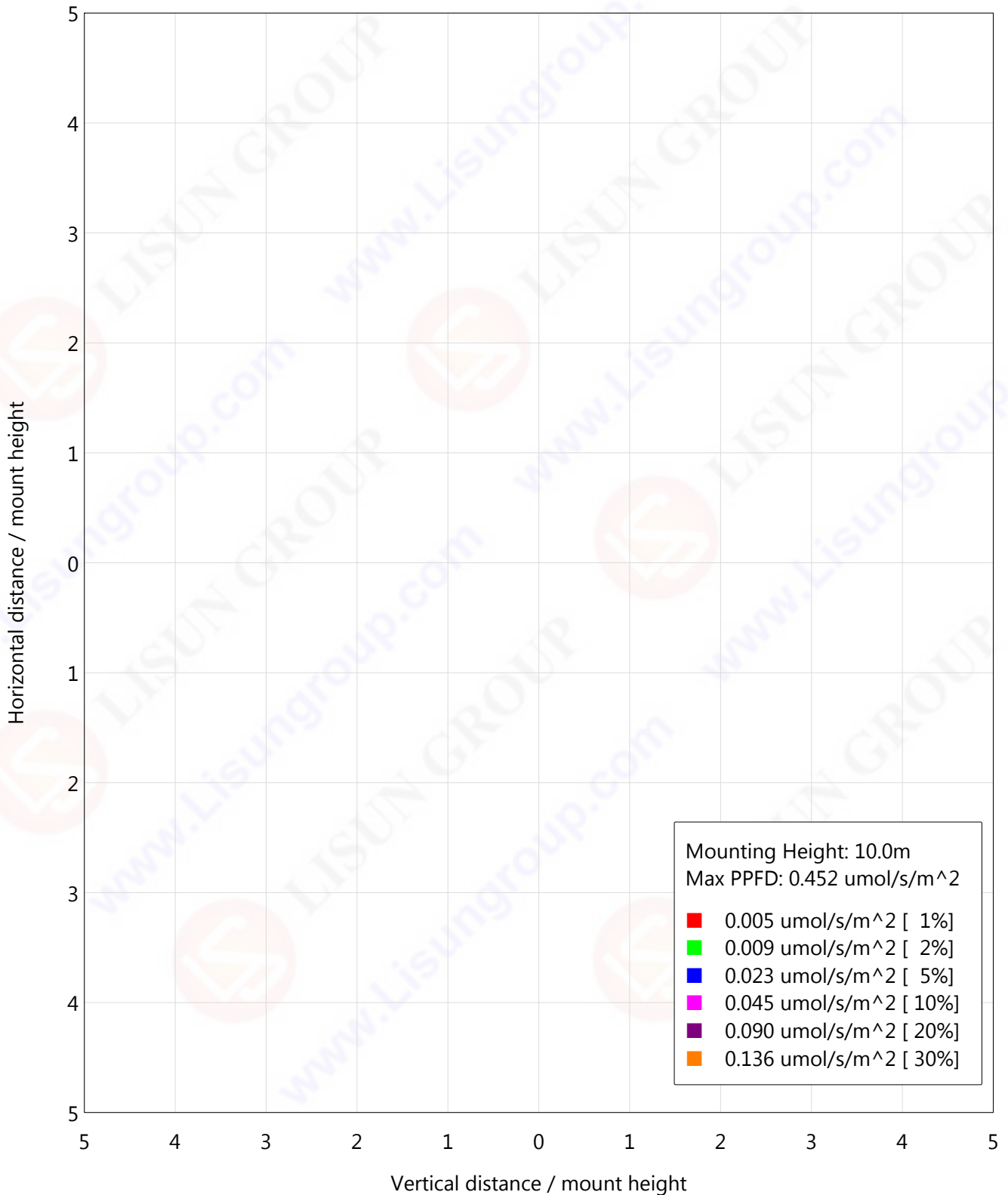
IsoPPFD

 Test Type : Type B
 Test Device : LSG-1890B
 Test Lab : LISUN GROUP
 Test By : Thomas Fiodorow

Test Distance : 8.460 m

 B Plane (°): -90.0-90.0:15.0 β (°): -90.0-90.0:1.0
 Temperature : 25°C Humidity : 65.0%

Review By :

Report No. : LISUN-003

Test Time : 2023-01-03 16:45:44

Page 9 of 31

Light Distribution Data

Unit: cd

V\H	H-90.0	H-89.0	H-88.0	H-87.0	H-86.0	H-85.0	H-84.0	H-83.0
V-90.0	3.6	3.6	3.6	3.6	3.6	3.6	3.6	3.6
V-75.0	3.6	3.6	3.6	3.6	3.6	3.6	3.6	3.6
V-60.0	4.5	3.6	3.6	3.6	3.6	3.6	4.5	5.4
V-45.0	4.5	4.5	3.6	3.6	4.5	6.3	9.0	11.7
V-30.0	4.5	4.5	3.6	4.5	5.4	8.1	11.7	15.3
V-15.0	4.5	4.5	4.5	5.4	8.1	11.7	15.3	21.6
V0.0	4.5	4.5	4.5	5.4	7.2	10.8	15.3	20.7
V15.0	5.4	5.4	5.4	6.3	8.1	11.7	16.2	21.6
V30.0	7.2	7.2	7.2	7.2	8.1	10.8	14.4	18.0
V45.0	9.0	9.0	9.0	9.0	9.0	10.8	12.6	15.3
V60.0	9.9	9.9	9.9	9.9	9.9	9.9	10.8	11.7
V75.0	9.9	9.9	9.9	9.9	9.9	9.9	10.8	10.8
V90.0	9.9	9.9	9.9	9.9	9.9	9.9	10.8	10.8

Test Type : Type B

Test Distance : 8.460 m

B Plane (°): -90.0-90.0:15.0 β (°): -90.0-90.0:1.0

Test Device : LSG-1890B

Temperature : 25°C

Humidity : 65.0%

Test Lab : LISUN GROUP

Test By : Thomas Fiodorow

Review By :

Report No. : LISUN-003

Test Time : 2023-01-03 16:45:44

Page 10 of 31

Light Distribution Data

Unit: cd

V\H	H-82.0	H-81.0	H-80.0	H-79.0	H-78.0	H-77.0	H-76.0	H-75.0
V-90.0	3.6	3.6	3.6	3.6	3.6	3.6	3.6	3.6
V-75.0	3.6	3.6	4.5	5.4	6.3	7.2	8.1	9.0
V-60.0	7.2	9.0	11.7	13.5	16.2	19.8	24.3	31.5
V-45.0	15.3	18.9	25.2	38.7	57.6	81.0	107.1	135.0
V-30.0	20.7	28.8	49.5	74.7	105.3	140.4	183.6	224.0
V-15.0	34.2	59.4	89.1	127.8	172.8	224.0	278.9	337.4
V0.0	29.7	53.1	87.3	125.1	165.6	214.1	273.5	326.6
V15.0	32.4	56.7	89.1	122.4	165.6	211.4	268.1	320.3
V30.0	22.5	30.6	45.0	69.3	99.0	135.0	168.3	211.4
V45.0	18.9	23.4	28.8	35.1	52.2	71.1	95.4	118.8
V60.0	12.6	14.4	16.2	18.9	21.6	24.3	27.0	30.6
V75.0	10.8	11.7	11.7	12.6	13.5	13.5	14.4	15.3
V90.0	10.8	11.7	11.7	12.6	12.6	12.6	12.6	12.6

Test Type : Type B

Test Distance : 8.460 m

B Plane (°): -90.0-90.0:15.0 β (°): -90.0-90.0:1.0

Test Device : LSG-1890B

Temperature : 25°C

Humidity : 65.0%

Test Lab : LISUN GROUP

Test By : Thomas Fiodorow

Review By :

Report No. : LISUN-003

Test Time : 2023-01-03 16:45:44

Page 11 of 31

Light Distribution Data

Unit: cd

V\H	H-74.0	H-73.0	H-72.0	H-71.0	H-70.0	H-69.0	H-68.0	H-67.0
V-90.0	3.6	3.6	3.6	3.6	3.6	3.6	3.6	3.6
V-75.0	9.9	10.8	12.6	13.5	15.3	16.2	18.0	20.7
V-60.0	41.4	54.0	66.6	83.7	99.9	117.9	137.7	160.2
V-45.0	167.4	200.6	239.3	282.5	327.5	369.8	417.5	476.0
V-30.0	275.3	323.0	372.5	431.9	505.7	554.3	619.0	680.2
V-15.0	392.3	457.1	539.9	600.1	687.4	745.9	809.8	911.5
V0.0	394.1	454.4	537.2	598.3	686.5	746.8	811.6	915.1
V15.0	385.1	447.2	527.3	585.7	667.6	730.6	790.0	883.6
V30.0	255.5	304.1	355.4	413.9	465.2	535.4	583.0	653.2
V45.0	148.5	180.9	215.0	251.0	288.8	334.7	370.7	422.0
V60.0	35.1	44.1	54.0	65.7	78.3	92.7	108.0	126.0
V75.0	15.3	16.2	17.1	18.0	18.9	19.8	20.7	21.6
V90.0	12.6	12.6	12.6	12.6	12.6	12.6	12.6	12.6

Test Type : Type B

Test Distance : 8.460 m

B Plane (°): -90.0-90.0:15.0 β (°): -90.0-90.0:1.0

Test Device : LSG-1890B

Temperature : 25°C

Humidity : 65.0%

Test Lab : LISUN GROUP

Test By : Thomas Fiodorow

Review By :

Report No. : LISUN-003

Test Time : 2023-01-03 16:45:44

Page 12 of 31

Light Distribution Data

Unit: cd

V\H	H-66.0	H-65.0	H-64.0	H-63.0	H-62.0	H-61.0	H-60.0	H-59.0
V-90.0	3.6	3.6	3.6	3.6	3.6	3.6	3.6	3.6
V-75.0	22.5	25.2	28.8	33.3	36.9	41.4	46.8	52.2
V-60.0	184.5	203.3	225.8	257.3	278.0	311.3	334.7	366.2
V-45.0	513.8	559.7	622.6	663.1	705.4	771.1	826.9	871.0
V-30.0	736.0	803.5	881.8	934.9	991.5	1045.5	1098.6	1157.1
V-15.0	969.9	1038.3	1095.9	1156.2	1224.6	1290.3	1360.4	1431.5
V0.0	974.4	1044.6	1104.9	1164.3	1232.7	1302.9	1372.1	1445.9
V15.0	951.0	1016.7	1076.1	1133.7	1210.2	1275.0	1331.6	1400.0
V30.0	712.6	760.3	838.6	907.0	961.8	1014.9	1068.0	1122.0
V45.0	461.6	515.6	551.6	610.9	653.2	693.7	740.5	808.0
V60.0	142.2	162.9	181.8	198.8	224.0	241.1	269.0	288.8
V75.0	22.5	24.3	25.2	27.0	28.8	30.6	31.5	33.3
V90.0	12.6	12.6	12.6	12.6	12.6	12.6	12.6	12.6

Test Type : Type B

Test Distance : 8.460 m

B Plane (°): -90.0-90.0:15.0 β (°): -90.0-90.0:1.0

Test Device : LSG-1890B

Temperature : 25°C

Humidity : 65.0%

Test Lab : LISUN GROUP

Test By : Thomas Fiodorow

Review By :

Report No. : LISUN-003

Test Time : 2023-01-03 16:45:44

Page 13 of 31

Light Distribution Data

Unit: cd

V\H	H-58.0	H-57.0	H-56.0	H-55.0	H-54.0	H-53.0	H-52.0	H-51.0
V-90.0	3.6	3.6	3.6	3.6	3.6	3.6	3.6	3.6
V-75.0	58.5	63.9	70.2	75.6	82.8	89.1	95.4	101.7
V-60.0	392.3	416.6	441.8	481.4	503.0	526.4	557.0	597.4
V-45.0	917.8	961.8	1000.5	1050.9	1094.1	1140.9	1194.0	1240.8
V-30.0	1220.1	1275.9	1344.2	1399.1	1462.1	1515.2	1571.0	1635.8
V-15.0	1503.5	1577.3	1639.4	1706.8	1762.6	1820.2	1888.6	1943.5
V0.0	1518.8	1579.1	1653.8	1726.6	1785.1	1843.6	1904.8	1971.4
V15.0	1471.1	1543.1	1605.2	1675.4	1730.2	1786.9	1855.3	1909.3
V30.0	1172.4	1234.5	1296.6	1348.7	1401.8	1466.6	1522.4	1577.3
V45.0	852.1	889.0	933.1	969.9	1013.1	1052.7	1102.2	1143.6
V60.0	320.3	338.3	372.5	395.9	413.9	443.6	469.7	494.0
V75.0	36.0	38.7	41.4	45.0	46.8	50.4	53.1	55.8
V90.0	12.6	12.6	12.6	12.6	12.6	12.6	12.6	12.6

Test Type : Type B

Test Distance : 8.460 m

B Plane (°): -90.0-90.0:15.0 β (°): -90.0-90.0:1.0

Test Device : LSG-1890B

Temperature : 25°C

Humidity : 65.0%

Test Lab : LISUN GROUP

Test By : Thomas Fiodorow

Review By :

Report No. : LISUN-003

Test Time : 2023-01-03 16:45:44

Page 14 of 31

Light Distribution Data

Unit: cd

V\H	H-50.0	H-49.0	H-48.0	H-47.0	H-46.0	H-45.0	H-44.0	H-43.0
V-90.0	3.6	3.6	3.6	3.6	3.6	3.6	3.6	3.6
V-75.0	109.8	115.2	122.4	129.6	135.0	145.8	150.3	158.4
V-60.0	622.6	646.0	670.3	696.4	718.9	742.3	766.6	793.6
V-45.0	1286.7	1329.8	1373.9	1417.1	1468.4	1509.8	1547.6	1584.5
V-30.0	1689.8	1742.8	1794.1	1842.7	1887.7	1939.9	1982.2	2024.5
V-15.0	1996.6	2048.8	2100.0	2148.6	2202.6	2245.8	2288.1	2332.2
V0.0	2023.6	2073.9	2125.2	2176.5	2224.2	2280.0	2324.1	2369.1
V15.0	1959.7	2010.1	2061.4	2118.9	2163.9	2206.2	2247.6	2290.8
V30.0	1629.5	1679.0	1738.3	1786.0	1829.2	1871.5	1913.8	1957.0
V45.0	1185.9	1229.1	1271.4	1311.9	1363.1	1403.6	1441.4	1478.3
V60.0	514.7	542.6	574.9	596.5	617.2	642.4	662.2	682.0
V75.0	59.4	62.1	64.8	69.3	72.0	75.6	78.3	81.9
V90.0	12.6	12.6	12.6	12.6	12.6	12.6	12.6	12.6

Test Type : Type B

Test Distance : 8.460 m

B Plane (°): -90.0-90.0:15.0 β (°): -90.0-90.0:1.0

Test Device : LSG-1890B

Temperature : 25°C

Humidity : 65.0%

Test Lab : LISUN GROUP

Test By : Thomas Fiodorow

Review By :

Report No. : LISUN-003

Test Time : 2023-01-03 16:45:44

Page 15 of 31

Light Distribution Data

Unit: cd

V\H	H-42.0	H-41.0	H-40.0	H-39.0	H-38.0	H-37.0	H-36.0	H-35.0
V-90.0	3.6	3.6	3.6	3.6	3.6	3.6	3.6	3.6
V-75.0	165.6	171.0	175.5	184.5	191.6	197.0	201.5	209.6
V-60.0	820.6	846.7	877.3	900.7	923.2	947.4	970.8	993.3
V-45.0	1621.4	1657.4	1691.6	1731.1	1762.6	1794.1	1825.6	1855.3
V-30.0	2066.8	2107.2	2147.7	2187.3	2226.0	2271.9	2306.1	2337.6
V-15.0	2375.4	2416.8	2456.3	2502.2	2539.1	2576.0	2612.0	2645.3
V0.0	2414.1	2456.3	2496.8	2542.7	2578.7	2615.6	2650.7	2685.8
V15.0	2333.1	2374.5	2420.4	2456.3	2493.2	2529.2	2564.3	2597.6
V30.0	1998.4	2044.3	2080.2	2115.3	2151.3	2186.4	2218.8	2254.8
V45.0	1515.2	1548.5	1579.1	1614.2	1643.9	1674.5	1704.1	1730.2
V60.0	702.7	724.3	745.9	770.2	792.7	816.1	836.8	858.4
V75.0	84.6	89.1	90.9	96.3	99.0	100.8	105.3	108.0
V90.0	12.6	12.6	12.6	12.6	12.6	12.6	12.6	12.6

Test Type : Type B

Test Distance : 8.460 m

B Plane (°): -90.0-90.0:15.0 β (°): -90.0-90.0:1.0

Test Device : LSG-1890B

Temperature : 25°C

Humidity : 65.0%

Test Lab : LISUN GROUP

Test By : Thomas Fiodorow

Review By :

Report No. : LISUN-003

Test Time : 2023-01-03 16:45:44

Page 16 of 31

Light Distribution Data

Unit: cd

V\H	H-34.0	H-33.0	H-32.0	H-31.0	H-30.0	H-29.0	H-28.0	H-27.0
V-90.0	3.6	3.6	3.6	3.6	3.6	3.6	3.6	3.6
V-75.0	216.8	221.3	226.7	230.3	233.9	238.4	243.8	249.2
V-60.0	1019.4	1040.1	1059.0	1076.1	1093.2	1111.2	1128.3	1149.9
V-45.0	1888.6	1915.6	1941.7	1966.9	1991.2	2015.5	2038.0	2064.1
V-30.0	2367.3	2397.9	2427.6	2462.6	2490.5	2516.6	2542.7	2567.9
V-15.0	2675.9	2711.9	2739.8	2767.7	2794.7	2821.6	2848.6	2879.2
V0.0	2719.1	2751.5	2788.4	2816.3	2842.3	2869.3	2896.3	2922.4
V15.0	2634.5	2663.3	2690.3	2718.2	2744.3	2770.4	2801.9	2827.0
V30.0	2284.5	2315.1	2344.8	2374.5	2401.5	2426.7	2454.5	2477.0
V45.0	1755.4	1786.9	1812.1	1836.4	1858.9	1878.7	1900.3	1925.5
V60.0	878.2	898.0	916.0	935.8	951.9	966.3	980.7	996.0
V75.0	110.7	114.3	117.0	118.8	121.5	124.2	126.9	129.6
V90.0	12.6	12.6	12.6	12.6	12.6	12.6	12.6	12.6

Test Type : Type B

Test Distance : 8.460 m

B Plane (°): -90.0-90.0:15.0 β (°): -90.0-90.0:1.0

Test Device : LSG-1890B

Temperature : 25°C

Humidity : 65.0%

Test Lab : LISUN GROUP

Test By : Thomas Fiodorow

Review By :

Report No. : LISUN-003

Test Time : 2023-01-03 16:45:44

Page 17 of 31

Light Distribution Data

Unit: cd

V\H	H-26.0	H-25.0	H-24.0	H-23.0	H-22.0	H-21.0	H-20.0	H-19.0
V-90.0	3.6	3.6	3.6	3.6	3.6	3.6	3.6	3.6
V-75.0	254.6	259.1	263.6	268.1	273.5	277.1	280.7	285.2
V-60.0	1166.1	1181.4	1196.7	1210.2	1222.8	1237.2	1248.9	1260.6
V-45.0	2084.7	2104.5	2123.4	2142.3	2160.3	2181.0	2197.2	2211.6
V-30.0	2591.3	2620.1	2643.5	2666.9	2686.7	2704.7	2720.9	2738.9
V-15.0	2903.5	2925.1	2945.8	2965.6	2984.5	3007.0	3023.2	3040.3
V0.0	2948.5	2976.4	2998.0	3018.7	3036.7	3054.7	3075.4	3092.5
V15.0	2850.4	2871.1	2891.8	2911.6	2934.1	2952.1	2970.1	2986.3
V30.0	2498.6	2521.1	2542.7	2565.2	2585.0	2605.7	2622.8	2637.2
V45.0	1947.1	1966.0	1984.0	2000.2	2016.4	2036.2	2052.4	2067.7
V60.0	1008.6	1023.9	1035.6	1047.3	1059.0	1068.9	1079.7	1090.5
V75.0	130.5	132.3	135.0	136.8	138.6	140.4	142.2	144.9
V90.0	12.6	12.6	12.6	12.6	12.6	12.6	12.6	12.6

Test Type : Type B

Test Distance : 8.460 m

B Plane (°): -90.0-90.0:15.0 β (°): -90.0-90.0:1.0

Test Device : LSG-1890B

Temperature : 25°C

Humidity : 65.0%

Test Lab : LISUN GROUP

Test By : Thomas Fiodorow

Review By :

Report No. : LISUN-003

Test Time : 2023-01-03 16:45:44

Page 18 of 31

Light Distribution Data

Unit: cd

V\H	H-18.0	H-17.0	H-16.0	H-15.0	H-14.0	H-13.0	H-12.0	H-11.0
V-90.0	3.6	3.6	3.6	4.5	4.5	4.5	4.5	4.5
V-75.0	287.9	292.4	296.0	298.7	301.4	304.1	306.8	309.5
V-60.0	1272.3	1283.1	1293.0	1304.7	1313.7	1320.8	1327.1	1333.4
V-45.0	2226.0	2239.5	2251.2	2263.8	2276.4	2286.3	2295.3	2303.4
V-30.0	2753.3	2768.6	2783.0	2796.5	2810.0	2821.6	2833.3	2842.3
V-15.0	3055.6	3070.0	3082.6	3094.3	3106.9	3116.8	3125.8	3135.7
V0.0	3108.7	3124.9	3139.3	3152.8	3163.6	3175.3	3186.1	3195.1
V15.0	3002.5	3016.0	3029.5	3043.0	3053.8	3063.7	3072.7	3082.6
V30.0	2653.4	2667.8	2684.9	2699.3	2711.0	2722.7	2731.7	2739.8
V45.0	2080.2	2091.9	2102.7	2111.7	2125.2	2136.0	2145.9	2155.8
V60.0	1100.4	1109.4	1117.5	1124.7	1131.9	1140.0	1145.4	1150.8
V75.0	145.8	146.7	147.6	149.4	150.3	151.2	152.1	152.1
V90.0	12.6	12.6	12.6	12.6	12.6	12.6	12.6	12.6

Test Type : Type B

Test Distance : 8.460 m

B Plane (°): -90.0-90.0:15.0 β (°): -90.0-90.0:1.0

Test Device : LSG-1890B

Temperature : 25°C

Humidity : 65.0%

Test Lab : LISUN GROUP

Test By : Thomas Fiodorow

Review By :

Report No. : LISUN-003

Test Time : 2023-01-03 16:45:44

Page 19 of 31

Light Distribution Data

Unit: cd

V\H	H-10.0	H-9.0	H-8.0	H-7.0	H-6.0	H-5.0	H-4.0	H-3.0
V-90.0	4.5	4.5	4.5	4.5	4.5	4.5	4.5	4.5
V-75.0	312.2	314.0	314.9	316.7	317.6	319.4	321.2	321.2
V-60.0	1338.8	1346.0	1353.2	1357.7	1361.3	1364.9	1368.5	1372.1
V-45.0	2310.6	2317.8	2325.0	2330.4	2335.8	2339.4	2343.0	2345.7
V-30.0	2850.4	2858.5	2865.7	2872.9	2881.0	2886.4	2890.9	2892.7
V-15.0	3143.8	3151.9	3160.0	3167.2	3171.7	3176.2	3178.9	3179.8
V0.0	3203.1	3212.1	3220.2	3230.1	3236.4	3241.8	3245.4	3247.2
V15.0	3091.6	3101.5	3108.7	3115.0	3119.5	3124.0	3126.7	3128.5
V30.0	2747.9	2756.9	2764.1	2771.3	2777.6	2783.0	2787.5	2790.2
V45.0	2162.1	2167.5	2173.8	2179.2	2183.7	2188.2	2191.8	2192.7
V60.0	1156.2	1161.6	1166.1	1169.7	1172.4	1175.1	1176.9	1177.8
V75.0	153.0	153.9	154.8	154.8	154.8	154.8	155.7	155.7
V90.0	12.6	12.6	12.6	11.7	11.7	11.7	11.7	11.7

Test Type : Type B

Test Distance : 8.460 m

B Plane (°): -90.0-90.0:15.0 β (°): -90.0-90.0:1.0

Test Device : LSG-1890B

Temperature : 25°C

Humidity : 65.0%

Test Lab : LISUN GROUP

Test By : Thomas Fiodorow

Review By :

Report No. : LISUN-003

Test Time : 2023-01-03 16:45:44

Page 20 of 31

Light Distribution Data

Unit: cd

V\H	H-2.0	H-1.0	H0.0	H1.0	H2.0	H3.0	H4.0	H5.0
V-90.0	4.5	4.5	4.5	4.5	4.5	4.5	4.5	4.5
V-75.0	321.2	320.3	320.3	320.3	320.3	320.3	318.5	316.7
V-60.0	1373.0	1371.2	1370.3	1368.5	1367.6	1366.7	1365.8	1362.2
V-45.0	2345.7	2345.7	2343.9	2342.1	2339.4	2336.7	2333.1	2327.7
V-30.0	2893.6	2892.7	2892.7	2890.9	2890.0	2888.2	2886.4	2882.8
V-15.0	3181.6	3182.5	3181.6	3180.7	3179.8	3177.1	3173.5	3168.1
V0.0	3248.1	3249.0	3248.1	3247.2	3246.3	3244.5	3242.7	3240.0
V15.0	3130.3	3130.3	3130.3	3129.4	3127.6	3124.9	3120.4	3115.0
V30.0	2791.1	2792.0	2791.1	2791.1	2790.2	2788.4	2784.8	2781.2
V45.0	2191.8	2190.9	2189.1	2188.2	2188.2	2186.4	2183.7	2177.4
V60.0	1177.8	1177.8	1178.7	1177.8	1177.8	1176.0	1173.3	1169.7
V75.0	155.7	154.8	154.8	154.8	154.8	153.9	153.9	153.0
V90.0	11.7	11.7	11.7	11.7	11.7	11.7	11.7	11.7

Test Type : Type B

Test Distance : 8.460 m

B Plane (°): -90.0-90.0:15.0 β (°): -90.0-90.0:1.0

Test Device : LSG-1890B

Temperature : 25°C

Humidity : 65.0%

Test Lab : LISUN GROUP

Test By : Thomas Fiodorow

Review By :

Report No. : LISUN-003

Test Time : 2023-01-03 16:45:44

Page 21 of 31

Light Distribution Data

Unit: cd

V\H	H6.0	H7.0	H8.0	H9.0	H10.0	H11.0	H12.0	H13.0
V-90.0	4.5	4.5	4.5	4.5	4.5	4.5	4.5	4.5
V-75.0	314.9	313.1	312.2	311.3	308.6	305.9	302.3	299.6
V-60.0	1359.5	1355.9	1352.3	1347.8	1340.6	1331.6	1321.7	1313.7
V-45.0	2322.3	2316.0	2308.8	2301.6	2293.5	2284.5	2274.6	2262.9
V-30.0	2878.3	2871.1	2863.9	2855.8	2846.8	2837.8	2827.9	2818.1
V-15.0	3161.8	3154.6	3146.5	3137.5	3128.5	3116.8	3105.1	3093.4
V0.0	3233.7	3228.3	3220.2	3212.1	3203.1	3193.3	3183.4	3169.9
V15.0	3108.7	3101.5	3094.3	3086.2	3075.4	3065.5	3054.7	3043.0
V30.0	2774.9	2768.6	2760.5	2753.3	2743.4	2734.4	2725.4	2715.5
V45.0	2171.1	2164.8	2157.6	2150.4	2143.2	2135.1	2122.5	2109.9
V60.0	1165.2	1160.7	1155.3	1149.9	1144.5	1138.2	1132.8	1123.8
V75.0	152.1	152.1	150.3	150.3	148.5	147.6	146.7	144.9
V90.0	11.7	11.7	11.7	11.7	11.7	11.7	11.7	11.7

Test Type : Type B

Test Distance : 8.460 m

B Plane (°): -90.0-90.0:15.0 β (°): -90.0-90.0:1.0

Test Device : LSG-1890B

Temperature : 25°C

Humidity : 65.0%

Test Lab : LISUN GROUP

Test By : Thomas Fiodorow

Review By :

Report No. : LISUN-003

Test Time : 2023-01-03 16:45:44

Page 22 of 31

Light Distribution Data

Unit: cd

V\H	H14.0	H15.0	H16.0	H17.0	H18.0	H19.0	H20.0	H21.0
V-90.0	4.5	4.5	4.5	4.5	3.6	3.6	3.6	3.6
V-75.0	297.8	296.0	292.4	288.8	285.2	280.7	278.0	274.4
V-60.0	1306.5	1298.4	1289.4	1279.5	1267.8	1257.9	1246.2	1231.8
V-45.0	2250.3	2236.8	2221.5	2203.5	2188.2	2172.0	2156.7	2138.7
V-30.0	2805.5	2792.0	2777.6	2761.4	2744.3	2727.2	2706.5	2687.6
V-15.0	3081.7	3068.2	3053.8	3038.5	3017.8	3000.7	2981.8	2962.0
V0.0	3160.0	3148.3	3136.6	3122.2	3106.0	3085.3	3066.4	3046.6
V15.0	3030.4	3017.8	3002.5	2983.6	2967.4	2949.4	2931.4	2912.5
V30.0	2704.7	2692.1	2677.7	2658.8	2642.6	2626.4	2610.2	2592.2
V45.0	2096.4	2083.8	2071.2	2058.7	2042.5	2027.2	2010.1	1992.1
V60.0	1115.7	1107.6	1098.6	1088.7	1077.9	1064.4	1053.6	1042.8
V75.0	144.0	142.2	141.3	139.5	137.7	135.9	134.1	131.4
V90.0	11.7	10.8	10.8	10.8	10.8	10.8	10.8	10.8

Test Type : Type B

Test Distance : 8.460 m

B Plane (°): -90.0-90.0:15.0 β (°): -90.0-90.0:1.0

Test Device : LSG-1890B

Temperature : 25°C

Humidity : 65.0%

Test Lab : LISUN GROUP

Test By : Thomas Fiodorow

Review By :

Report No. : LISUN-003

Test Time : 2023-01-03 16:45:44

Page 23 of 31

Light Distribution Data

Unit: cd

V\H	H22.0	H23.0	H24.0	H25.0	H26.0	H27.0	H28.0	H29.0
V-90.0	3.6	3.6	3.6	3.6	3.6	3.6	3.6	3.6
V-75.0	270.8	265.4	260.0	255.5	250.1	243.8	238.4	232.1
V-60.0	1217.4	1203.0	1186.8	1172.4	1158.9	1143.6	1128.3	1111.2
V-45.0	2120.7	2100.9	2082.0	2058.7	2037.1	2014.6	1990.3	1964.2
V-30.0	2669.6	2650.7	2630.0	2608.4	2585.0	2554.4	2530.1	2505.8
V-15.0	2943.1	2921.5	2899.0	2871.1	2846.8	2821.6	2794.7	2767.7
V0.0	3025.9	3006.1	2984.5	2958.4	2935.0	2909.8	2883.7	2855.8
V15.0	2891.8	2871.1	2844.1	2820.7	2796.5	2771.3	2745.2	2718.2
V30.0	2572.4	2549.0	2527.4	2505.8	2482.4	2459.0	2434.8	2411.4
V45.0	1973.2	1955.2	1938.1	1913.8	1892.2	1867.9	1843.6	1821.1
V60.0	1031.1	1018.5	1005.0	992.4	974.4	959.1	943.8	929.5
V75.0	128.7	126.9	124.2	122.4	120.6	118.8	115.2	111.6
V90.0	9.9	9.9	9.9	9.9	9.9	9.9	9.9	9.9

Test Type : Type B

Test Distance : 8.460 m

B Plane (°): -90.0-90.0:15.0 β (°): -90.0-90.0:1.0

Test Device : LSG-1890B

Temperature : 25°C

Humidity : 65.0%

Test Lab : LISUN GROUP

Test By : Thomas Fiodorow

Review By :

Report No. : LISUN-003

Test Time : 2023-01-03 16:45:44

Page 24 of 31

Light Distribution Data

Unit: cd

V\H	H30.0	H31.0	H32.0	H33.0	H34.0	H35.0	H36.0	H37.0
V-90.0	3.6	3.6	3.6	3.6	3.6	3.6	3.6	3.6
V-75.0	227.6	223.1	217.7	210.5	201.5	196.1	190.7	184.5
V-60.0	1093.2	1070.7	1051.8	1032.9	1014.9	996.0	977.1	956.4
V-45.0	1938.1	1910.2	1878.7	1852.6	1825.6	1795.9	1764.4	1734.7
V-30.0	2479.7	2452.7	2423.1	2386.2	2353.8	2321.4	2288.1	2253.9
V-15.0	2739.8	2710.1	2673.2	2641.7	2609.3	2576.0	2540.0	2503.1
V0.0	2827.9	2799.2	2765.0	2735.3	2705.6	2673.2	2639.0	2601.2
V15.0	2690.3	2655.2	2624.6	2593.1	2560.7	2526.5	2492.3	2455.4
V30.0	2380.8	2353.8	2325.0	2294.4	2262.9	2231.4	2199.0	2158.5
V45.0	1798.6	1775.2	1743.7	1714.9	1687.1	1659.2	1631.3	1600.7
V60.0	915.1	898.9	881.8	862.0	843.1	823.3	803.5	783.7
V75.0	108.9	107.1	103.5	100.8	99.0	95.4	91.8	90.0
V90.0	9.9	9.0	9.0	9.0	9.0	9.0	9.0	9.0

Test Type : Type B

Test Distance : 8.460 m

B Plane (°): -90.0-90.0:15.0 β (°): -90.0-90.0:1.0

Test Device : LSG-1890B

Temperature : 25°C

Humidity : 65.0%

Test Lab : LISUN GROUP

Test By : Thomas Fiodorow

Review By :

Report No. : LISUN-003

Test Time : 2023-01-03 16:45:44

Page 25 of 31

Light Distribution Data

Unit: cd

V\H	H38.0	H39.0	H40.0	H41.0	H42.0	H43.0	H44.0	H45.0
V-90.0	3.6	3.6	3.6	3.6	3.6	3.6	3.6	3.6
V-75.0	175.5	170.1	164.7	156.6	148.5	144.0	137.7	129.6
V-60.0	928.6	904.3	880.0	853.0	827.8	803.5	771.1	745.0
V-45.0	1696.0	1662.8	1627.7	1590.8	1554.8	1519.7	1484.6	1447.7
V-30.0	2220.6	2177.4	2139.6	2100.9	2061.4	2021.8	1981.3	1939.9
V-15.0	2464.4	2418.6	2379.0	2338.5	2297.1	2253.0	2208.0	2163.0
V0.0	2563.4	2516.6	2478.8	2438.4	2397.0	2354.7	2310.6	2257.5
V15.0	2409.6	2370.9	2332.2	2291.7	2250.3	2206.2	2163.0	2118.0
V30.0	2124.3	2089.2	2052.4	2014.6	1977.7	1931.8	1892.2	1850.8
V45.0	1568.3	1536.8	1499.9	1468.4	1433.3	1397.3	1361.3	1324.4
V60.0	762.1	734.2	712.6	688.3	665.8	645.1	624.4	597.4
V75.0	86.4	82.8	81.0	78.3	74.7	72.9	68.4	65.7
V90.0	9.0	9.0	9.0	9.0	9.0	9.0	9.0	9.0

Test Type : Type B

Test Distance : 8.460 m

B Plane (°): -90.0-90.0:15.0 β (°): -90.0-90.0:1.0

Test Device : LSG-1890B

Temperature : 25°C

Humidity : 65.0%

Test Lab : LISUN GROUP

Test By : Thomas Fiodorow

Review By :

Report No. : LISUN-003

Test Time : 2023-01-03 16:45:44

Page 26 of 31

Light Distribution Data

Unit: cd

V\H	H46.0	H47.0	H48.0	H49.0	H50.0	H51.0	H52.0	H53.0
V-90.0	3.6	3.6	3.6	3.6	3.6	3.6	3.6	3.6
V-75.0	124.2	118.8	111.6	105.3	98.1	93.6	86.4	81.9
V-60.0	718.9	692.8	668.5	646.0	622.6	590.2	549.8	524.6
V-45.0	1408.1	1357.7	1312.8	1265.1	1218.3	1174.2	1127.4	1072.5
V-30.0	1885.9	1840.0	1795.0	1750.0	1702.3	1652.0	1601.6	1540.4
V-15.0	2118.0	2061.4	2011.0	1960.6	1908.4	1856.2	1804.9	1738.3
V0.0	2212.5	2166.6	2118.9	2068.6	2016.4	1962.4	1899.4	1845.4
V15.0	2064.1	2017.3	1966.9	1916.5	1865.2	1815.7	1752.7	1696.9
V30.0	1806.7	1762.6	1717.6	1664.6	1617.8	1569.2	1517.9	1467.5
V45.0	1284.0	1232.7	1190.4	1148.1	1104.0	1059.9	1019.4	968.1
V60.0	577.6	557.0	537.2	503.9	476.9	458.0	435.5	407.6
V75.0	62.1	59.4	56.7	53.1	51.3	47.7	45.0	42.3
V90.0	9.0	9.0	9.0	9.0	9.0	9.0	9.0	9.0

Test Type : Type B

Test Distance : 8.460 m

B Plane (°): -90.0-90.0:15.0 β (°): -90.0-90.0:1.0

Test Device : LSG-1890B

Temperature : 25°C

Humidity : 65.0%

Test Lab : LISUN GROUP

Test By : Thomas Fiodorow

Review By :

Report No. : LISUN-003

Test Time : 2023-01-03 16:45:44

Page 27 of 31

Light Distribution Data

Unit: cd

V\H	H54.0	H55.0	H56.0	H57.0	H58.0	H59.0	H60.0	H61.0
V-90.0	3.6	3.6	3.6	3.6	3.6	3.6	3.6	3.6
V-75.0	73.8	69.3	63.0	57.6	51.3	47.7	43.2	38.7
V-60.0	498.5	476.0	441.8	410.3	386.9	363.5	330.2	308.6
V-45.0	1028.4	983.4	930.4	892.6	848.5	801.7	737.8	687.4
V-30.0	1486.4	1418.9	1361.3	1295.7	1239.0	1175.1	1114.8	1051.8
V-15.0	1682.6	1626.8	1555.7	1491.8	1416.2	1347.8	1286.7	1216.5
V0.0	1791.4	1727.5	1670.0	1598.9	1535.9	1460.3	1387.4	1313.7
V15.0	1641.2	1585.4	1512.5	1448.6	1378.4	1308.3	1237.2	1182.3
V30.0	1402.7	1346.9	1281.3	1227.3	1165.2	1106.7	1056.3	996.0
V45.0	928.6	889.9	844.9	809.8	748.6	700.0	659.5	621.7
V60.0	380.6	359.9	343.7	306.8	291.5	274.4	243.8	226.7
V75.0	39.6	36.9	35.1	32.4	29.7	27.9	26.1	24.3
V90.0	9.0	8.1	8.1	8.1	8.1	8.1	8.1	8.1

Test Type : Type B

Test Distance : 8.460 m

B Plane (°): -90.0-90.0:15.0 β (°): -90.0-90.0:1.0

Test Device : LSG-1890B

Temperature : 25°C

Humidity : 65.0%

Test Lab : LISUN GROUP

Test By : Thomas Fiodorow

Review By :

Report No. : LISUN-003

Test Time : 2023-01-03 16:45:44

Page 28 of 31

Light Distribution Data

Unit: cd

V\H	H62.0	H63.0	H64.0	H65.0	H66.0	H67.0	H68.0	H69.0
V-90.0	3.6	3.6	3.6	3.6	3.6	3.6	3.6	3.6
V-75.0	34.2	30.6	27.0	24.3	21.6	19.8	18.0	16.2
V-60.0	282.5	256.4	235.7	208.7	189.8	166.5	144.0	123.3
V-45.0	648.7	603.7	533.6	499.4	459.8	403.1	369.8	321.2
V-30.0	992.4	937.6	885.4	810.7	736.9	682.0	623.5	556.1
V-15.0	1149.9	1079.7	1020.3	951.0	889.9	787.3	735.1	676.6
V0.0	1243.5	1175.1	1107.6	1032.0	971.7	901.6	799.0	736.9
V15.0	1113.9	1049.1	981.6	924.1	846.7	765.7	704.5	643.3
V30.0	943.8	891.7	810.7	745.0	699.1	640.6	564.1	518.3
V45.0	563.3	519.2	485.9	429.2	394.1	357.2	315.8	287.0
V60.0	205.1	187.2	167.4	148.5	132.3	115.2	98.1	86.4
V75.0	23.4	21.6	20.7	18.9	18.0	17.1	15.3	14.4
V90.0	8.1	8.1	8.1	8.1	8.1	8.1	8.1	8.1

Test Type : Type B

Test Distance : 8.460 m

B Plane (°): -90.0-90.0:15.0 β (°): -90.0-90.0:1.0

Test Device : LSG-1890B

Temperature : 25°C

Humidity : 65.0%

Test Lab : LISUN GROUP

Test By : Thomas Fiodorow

Review By :

Report No. : LISUN-003

Test Time : 2023-01-03 16:45:44

Page 29 of 31

Light Distribution Data

Unit: cd

V\H	H70.0	H71.0	H72.0	H73.0	H74.0	H75.0	H76.0	H77.0
V-90.0	3.6	3.6	3.6	3.6	3.6	3.6	3.6	3.6
V-75.0	14.4	13.5	11.7	10.8	9.9	8.1	7.2	6.3
V-60.0	104.4	88.2	73.8	60.3	47.7	36.9	27.9	23.4
V-45.0	289.7	244.7	208.7	172.8	141.3	113.4	90.9	66.6
V-30.0	508.4	431.9	392.3	329.3	287.9	240.2	197.0	151.2
V-15.0	587.5	528.2	453.5	402.2	340.1	286.1	237.5	189.8
V0.0	674.8	586.6	534.5	453.5	402.2	333.8	281.6	225.8
V15.0	563.3	512.9	438.2	388.7	323.9	268.1	221.3	174.6
V30.0	453.5	406.7	346.4	309.5	258.2	214.1	171.9	135.9
V45.0	245.6	206.9	174.6	146.7	119.7	94.5	72.0	55.8
V60.0	72.0	62.1	52.2	42.3	34.2	28.8	24.3	20.7
V75.0	13.5	12.6	11.7	10.8	10.8	9.9	9.0	8.1
V90.0	8.1	8.1	8.1	8.1	8.1	8.1	8.1	8.1

Test Type : Type B

Test Distance : 8.460 m

B Plane (°): -90.0-90.0:15.0 β (°): -90.0-90.0:1.0

Test Device : LSG-1890B

Temperature : 25°C

Humidity : 65.0%

Test Lab : LISUN GROUP

Test By : Thomas Fiodorow

Review By :

Report No. : LISUN-003

Test Time : 2023-01-03 16:45:44

Page 30 of 31

Light Distribution Data

Unit: cd

V\H	H78.0	H79.0	H80.0	H81.0	H82.0	H83.0	H84.0	H85.0
V-90.0	3.6	4.5	3.6	4.5	4.5	4.5	4.5	4.5
V-75.0	5.4	5.4	4.5	3.6	3.6	3.6	3.6	3.6
V-60.0	18.9	16.2	12.6	10.8	9.0	7.2	5.4	4.5
V-45.0	48.6	33.3	24.3	18.0	14.4	10.8	8.1	6.3
V-30.0	116.1	82.8	57.6	37.8	25.2	17.1	12.6	9.0
V-15.0	144.0	104.4	71.1	46.8	28.8	18.9	13.5	9.9
V0.0	177.3	134.1	94.5	63.9	39.6	23.4	16.2	10.8
V15.0	139.5	98.1	67.5	43.2	27.0	18.9	13.5	9.9
V30.0	100.8	74.7	51.3	33.3	23.4	18.0	13.5	9.9
V45.0	39.6	28.8	23.4	18.9	15.3	11.7	9.0	7.2
V60.0	18.0	16.2	13.5	11.7	9.9	9.0	8.1	7.2
V75.0	8.1	8.1	7.2	7.2	7.2	8.1	8.1	8.1
V90.0	8.1	8.1	8.1	8.1	8.1	8.1	8.1	8.1

Test Type : Type B

Test Distance : 8.460 m

B Plane (°): -90.0-90.0:15.0 β (°): -90.0-90.0:1.0

Test Device : LSG-1890B

Temperature : 25°C

Humidity : 65.0%

Test Lab : LISUN GROUP

Test By : Thomas Fiodorow

Review By :

Report No. : LISUN-003

Test Time : 2023-01-03 16:45:44

Page 31 of 31

Light Distribution Data

Unit: cd

V\H	H86.0	H87.0	H88.0	H89.0	H90.0			
V-90.0	4.5	4.5	4.5	4.5	4.5			
V-75.0	3.6	3.6	3.6	3.6	3.6			
V-60.0	3.6	3.6	3.6	4.5	4.5			
V-45.0	4.5	3.6	3.6	3.6	3.6			
V-30.0	6.3	4.5	3.6	3.6	3.6			
V-15.0	6.3	4.5	3.6	3.6	3.6			
V0.0	7.2	4.5	2.7	3.6	3.6			
V15.0	6.3	4.5	3.6	3.6	3.6			
V30.0	7.2	5.4	5.4	5.4	5.4			
V45.0	6.3	6.3	6.3	6.3	6.3			
V60.0	7.2	7.2	7.2	7.2	7.2			
V75.0	8.1	8.1	8.1	7.2	7.2			
V90.0	8.1	8.1	8.1	7.2	7.2			

Test Type : Type B

Test Distance : 8.460 m

B Plane (°): -90.0-90.0:15.0 β (°): -90.0-90.0:1.0

Test Device : LSG-1890B

Temperature : 25°C

Humidity : 65.0%

Test Lab : LISUN GROUP

Test By : Thomas Fiodorow

Review By :